

# TECHLINE HCVXR AND CV DESIGN GUIDE

**DRIPLINE FOR SUBSURFACE AND ON-SURFACE**

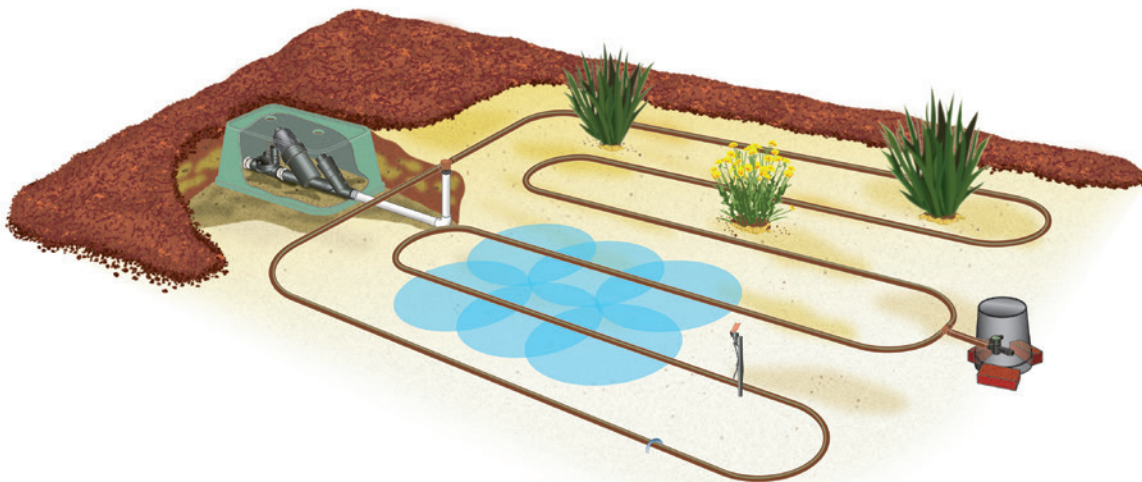
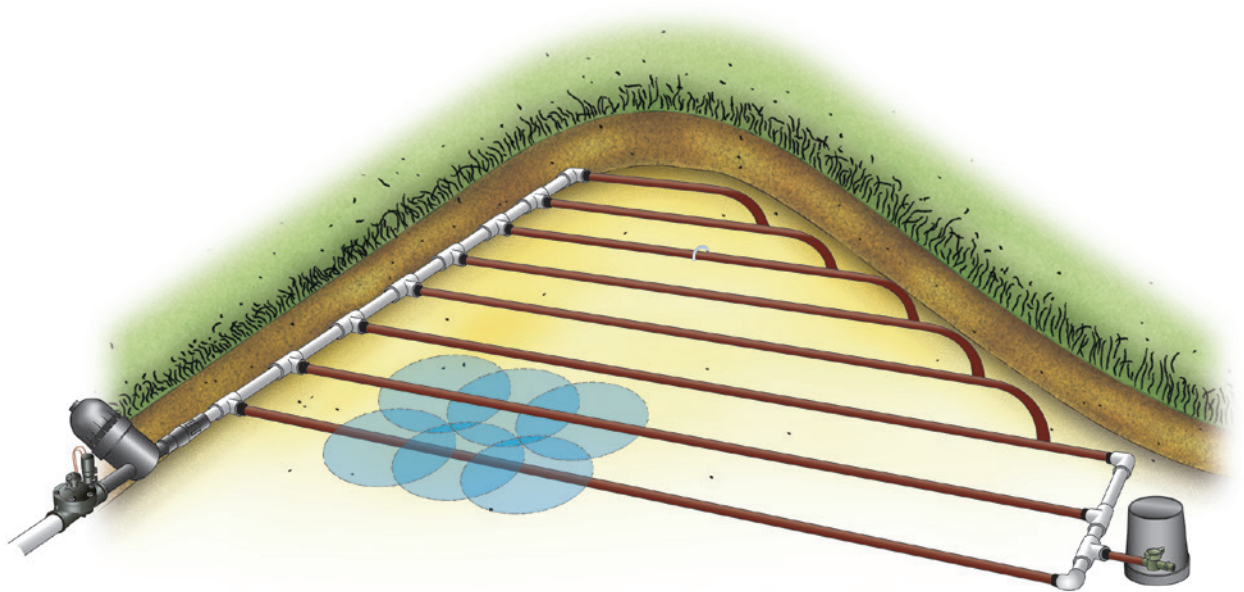

# NETAFIM TECHLINE® HCVXR and CV DESIGN GUIDE

---

## TABLE OF CONTENTS

### INTRODUCTION

Overview.....	3
---------------	---

### DESIGN CRITERIA

Site Survey.....	4
Point of Connection.....	4

### BASIC DESIGN STEPS

When Should You Use Techline HCVXR or CV.....	5
Choosing the Proper Techline HCVXR or CV.....	5
General Guidelines Charts.....	6
Types of Layouts.....	7
What Do These Layouts Have in Common?.....	7
GRID Layout.....	7
LITE Layout.....	8
Calculating Equal Row Spacing.....	8
Length of Techline Rows.....	9
Maximum Length of Laterals Charts.....	9
Center Feed GRID Layout.....	10
Other GRID Layout Considerations.....	10
Creating Sub-Headers to Reduce Glue/Saddle Joints.....	11
Zone Water Requirements.....	11
Flow Per 100' Charts.....	11
Calculating Total Zone Water Demand.....	12
Fittings.....	13
Staples.....	14
Line Flushing Valves.....	14
If An Automatic Flush Valve is Not Desired.....	14
If An Air/Vacuum Relief Vent is Desired.....	15
Filters.....	16
Disc Filter Sizing Charts.....	16
Pressure Regulating Valves (PRV).....	17
Pressure Regulator Sizing Charts.....	18
Low Volume Control Zone Kits - Disc.....	19
Low Volume Control Zone Kits - Screen.....	20
Slopes and Berms.....	21
In-Line Check Valve.....	21
Trees.....	22
Pressure and Flow Checks.....	22
Calculating Precipitation Rates.....	22

# NETAFIM TECHLINE® HCVXR and CV DESIGN GUIDE

---

## TABLE OF CONTENTS (CONTINUED)

### TECHLINE HCVXR AND CV IN TURF

Turfgrass.....	23
Where and Why to Use Techline in Turf .....	23
Tips for Using Techline in a Newly-Sodded Lawn.....	24

### SPECIAL APPLICATIONS AND TIPS

Parking Lot Islands.....	25
Electrical Grounding.....	25
Above and Below Grade.....	25

### WINTERIZING INSTRUCTIONS

Winterizing Instructions.....	26
Manual Winterization.....	26
Compressed Air Winterization.....	26

### TECHNICAL DATA

Techline HCVXR Dripline.....	27
Techline CV Dripline .....	28
Techline CV and Techline HCVXR Emitters.....	29
Design Formulas.....	30
Specifying Model Numbers.....	32
Techline HCVXR Application Rate Tables .....	33
Techline CV Application Rate Tables.....	34
End Feed Layout.....	35
Slope Layout.....	36
Block System on Slope Layout .....	37
Center Feed Layout.....	38
Installation Checklist.....	39
System Inspection Checklist.....	40
Friction Loss Charts.....	41

# NETAFIM TECHLINE® HCVXR and CV DESIGN GUIDE

---

## INTRODUCTION

This manual covers the basics of design, installation, and maintenance of Techline HCVXR and CV integral driplines. Included are design steps, technical data, design layouts, as well as some design and installation details and checklists using both the GRID and LITE layout methods.

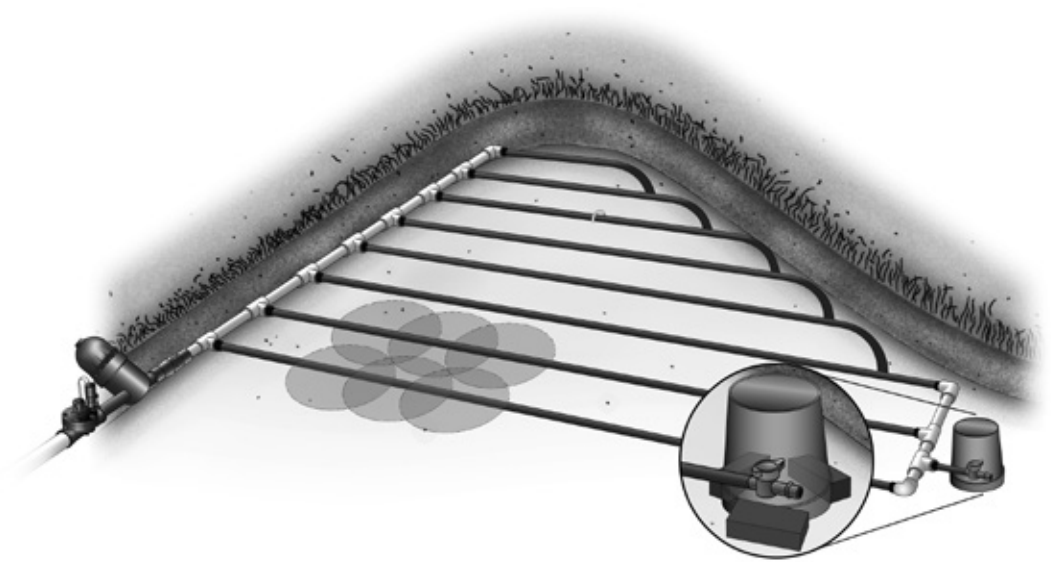

## OVERVIEW:

- Netafim is the world leader in low volume irrigation. Since the early 1960's Netafim has pioneered the science of subsurface, on-surface and point source irrigation and manufacturing. Serving more than 110 countries worldwide, Netafim products are sold in the Landscape & Turf market, as well as agriculture, greenhouse and nursery, wastewater and mining.
- The Techline HCVXR and CV family of products have been used successfully in landscape since 1987 in North America. Techline HCVXR and CV allow for even more water conserving designs because check valves are built into every emitter.
- Landscape architects, contractors, designers and consultants recognize the benefits of using low volume and drip irrigation for new plantings because of its accelerated plant growth compared to overhead spray and rotor irrigation. Coupling the rapid growth with dramatic water savings and low volume irrigation becomes an important part of any irrigation system.
- With the flexibility and quality of Netafim products, architects, designers, and contractors have highly sophisticated solutions to client and installation issues by bringing drip and subsurface components together to grow plants, trees, shrubs, groundcover, and yes, even turf.

# NETAFIM TECHLINE® HCVXR and CV DESIGN GUIDE

---

## DESIGN CRITERIA

Designing with Techline HCVXR and CV follows the same basic rules as designing with Techline DL, sprays and rotors.

- Point of connection, static and operating pressures, flow rates, and type of materials being irrigated are the same.
- Designing similar areas into a zone and not mixing products with different application rates is just like sprinkler design.
- The essential differences include knowing the type of soil you are working with, and the method of layout you use in the design.

### SITE SURVEY:

- Obtain or draw a scaled plan of the site to be irrigated. Identify all slopes on the plan.
- Identify the type of soil (sand, loam, clay or coarse soil).
- Determine types of materials to be irrigated, turf, groundcover, shrubs, plants, and trees.

### POINT OF CONNECTION:

- Type of water, potable, well, pump, effluent, etc.
- Pressure and volume available - static and operating tests.

**Note:** For Techline HCVXR and CV Technical Product Application and Specifications, see page 27 and 28.

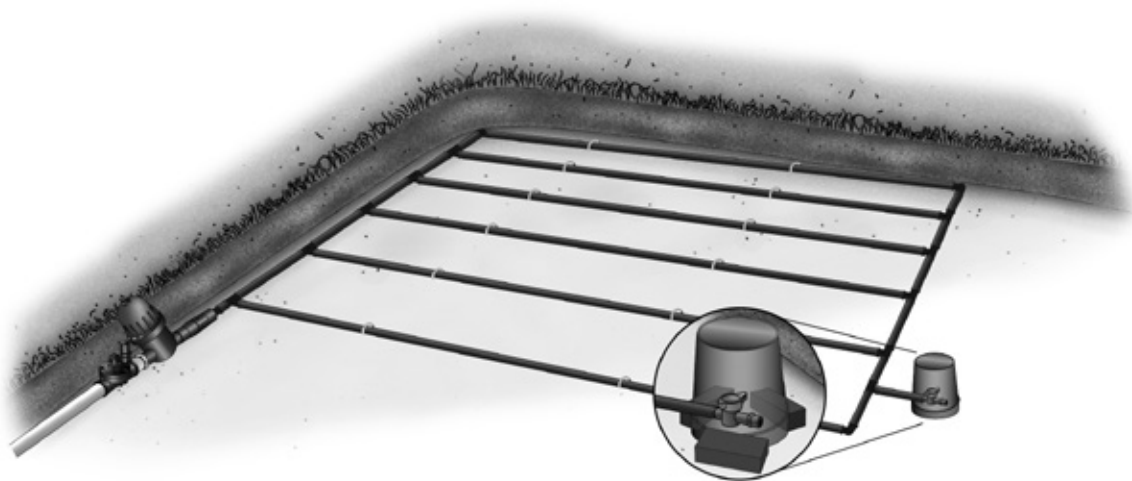

## **BASIC DESIGN STEPS**

### **WHEN SHOULD YOU USE TECHLINE HCVXR OR CV?**

- Anytime you want to create an even wetted pattern of water throughout an area.
- Since the object of sprinklers is also to create an even wetted pattern, you can use Techline HCVXR and CV anytime you can use sprinklers.

### **CHOOSING THE PROPER TECHLINE HCVXR OR CV:**

- From Table 1: General Guidelines (page 6), answer two questions:
  1. Are you irrigating a Shrub and Groundcover area or Turf?
  2. Is the soil Clay, Loam, Sandy or Coarse Soil?
- Follow the proper column listed under Turf or Shrub & Groundcover to identify the proper Techline. Example - If you choose Shrub and Groundcover, with loam soil, 0.4 GPH/18" Techline CV is the proper choice. (Each emitter will deliver 0.4 GPH and the emitters, mounted inside the tubing, are spaced 18" apart.)
- What other information is in the General Guidelines table?
  1. How far to spread out the laterals is listed on the "Lateral (Row) Spacings" line. (For this example, rows should be evenly spaced anywhere from 18" - 24" apart.)
  2. The corresponding application rates and time to apply are listed after the Lateral Spacings line. (With rows of 0.4 GPH/18" Techline CV every 18" apart, the application rate is 0.30 inches per hour and it will take 50 minutes to apply 1/4" of water. If the rows are 24" apart, the application rate is 0.23 inches per hour, and it will take 66 minutes to apply 1/4" of water. For other row spacings see Application Rates Tables, pages 33 and 34.

# NETAFIM TECHLINE® HCVXR and CV DESIGN GUIDE

## BASIC DESIGN STEPS (CONTINUED)

**TABLE 1: GENERAL GUIDELINES**

TECHLINE HCVXR	TURF												SHRUB & GROUNDCOVER											
	CLAY SOIL			LOAM SOIL			SANDY SOIL			COARSE SOIL			CLAY SOIL		LOAM SOIL		SANDY SOIL		COARSE SOIL					
EMITTER FLOW	0.33 GPH			0.53 GPH			0.77 GPH			1.16 GPH			0.33 GPH		0.53 GPH		0.77 GPH		1.16 GPH					
EMITTER SPACING	18"			12"			12"			12"			18"		18"		12"		12"					
LATERAL (ROW) SPACING	18"	20"	22"	12"	18"	20"	12"	14"	16"	12"	14"	16"	18"	21"	24"	18"	21"	24"	16"	18"	20"	16"	18"	20"
BURIAL DEPTH	Bury evenly throughout the zone from 4" to 6"												On-surface or bury evenly throughout the zone to a maximum of 6"											
APPLICATION RATE (INCHES/HOUR)	0.24	0.21	0.19	0.85	0.56	0.51	1.23	1.05	0.92	1.86	1.60	1.40	0.24	0.20	0.18	0.38	0.32	0.28	0.92	0.82	0.74	1.40	1.24	1.12
TIME TO APPLY ¼" OF WATER (MINUTES)	64	71	78	18	27	30	12	14	16	8	9	11	64	74	85	40	46	53	16	18	20	11	12	13
Following these maximum spacing guidelines, emitter flow selection can be increased if desired by the designer. 1.16 GPH flow rate available for areas requiring higher infiltration rates, such as coarse sandy soils.																								

TECHLINE CV	TURF												SHRUB & GROUNDCOVER											
	CLAY SOIL			LOAM SOIL			SANDY SOIL			COARSE SOIL			CLAY SOIL		LOAM SOIL		SANDY SOIL		COARSE SOIL					
EMITTER FLOW	0.26 GPH			0.4 GPH			0.6 GPH			0.9 GPH			0.26 GPH		0.4 GPH		0.6 GPH		0.9 GPH					
EMITTER SPACING	18"			12"			12"			12"			18"		18"		12"		12"					
LATERAL (ROW) SPACING	18"	20"	22"	12"	14"	18"	12"	14"	18"	12"	14"	16"	18"	21"	24"	18"	21"	24"	16"	18"	20"	16"	18"	20"
BURIAL DEPTH	Bury evenly throughout the zone from 4" to 6"												On-surface or bury evenly throughout the zone to a maximum of 6"											
APPLICATION RATE (INCHES/HOUR)	0.19	0.17	0.15	0.64	0.55	0.43	0.98	0.84	0.65	1.48	1.27	1.11	0.19	0.16	0.14	0.30	0.26	0.23	0.73	0.65	0.59	1.11	0.99	0.89
TIME TO APPLY ¼" OF WATER (MINUTES)	80	89	97	23	27	35	15	18	23	10	12	13	80	93	106	50	58	66	20	23	26	13	15	17
Following these maximum spacing guidelines, emitter flow selection can be increased if desired by the designer. 0.9 GPH flow rate available for areas requiring higher infiltration rates, such as coarse sandy soils.																								

Note: 0.4, 0.6 and 0.9 GPH are nominal flow rates. Actual flow rates used in the calculations are 0.42, 0.61 and 0.92 GPH.

# NETAFIM TECHLINE® HCVXR and CV DESIGN GUIDE

## BASIC DESIGN STEPS (CONTINUED)

### TYPES OF LAYOUTS:

There are two layout methods we recommend - GRID and LITE. Both accomplish the same goal, but one method will be the preferred method based on what and how you are irrigating.

### WHAT DO THESE LAYOUTS HAVE IN COMMON?

- Both methods assume even row spacings will be maintained
- Both methods are designed to flow water in a loop manner

### GRID:

- This is the preferred method for installing Techline HCVXR and CV subsurface
- This method uses supply and exhaust headers with rows of Techline connected at each end
- The supply header delivers water to each row of Techline
- The exhaust header forms a continuous loop, or return leg, so all rows of Techline are being supplied from both ends
- This interconnection of the piping network is the GRID layout. This evens out the flow, helps ensure water is being delivered downstream of any break in the laterals, and allows for much easier repairs of any line breaks.

### Basic GRID Layout

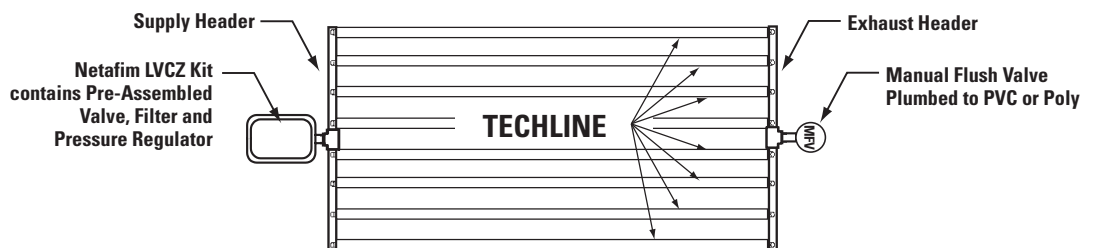

### BASIC GRID LAYOUT:

- Headers should be indented 2" - 4" from hardscapes and planting areas.
- Headers may be PVC, polyethylene or in zones under 5 GPM, Techline HCVXR and CV or Techline Blank Tubing.
- Headers must be sized to accommodate the flow of the zone without exceeding 5 feet per second velocity. (Zone Water Requirement calculations are on pages 11 and 12.)
- Start rows of Techline 2" - 4" away from the edge of hardscapes, and move across the area with equal row spacing that does not exceed the recommendations of Table 1: General Guidelines (see page 6). (The 2" setback will help provide enough moisture to prevent heat damage to plant material generated by hardscapes such as asphalt). Start rows about 4" away from planting beds.



# NETAFIM TECHLINE® HCVXR and CV DESIGN GUIDE

## BASIC DESIGN STEPS (CONTINUED)

### LITE:

- The LITE layout is used exclusively on-surface
- It is the fastest and easiest layout method because no supply and exhaust headers are used
- The dripline simply weaves back and forth throughout the zone in evenly spaced rows

### Basic LITE Layout

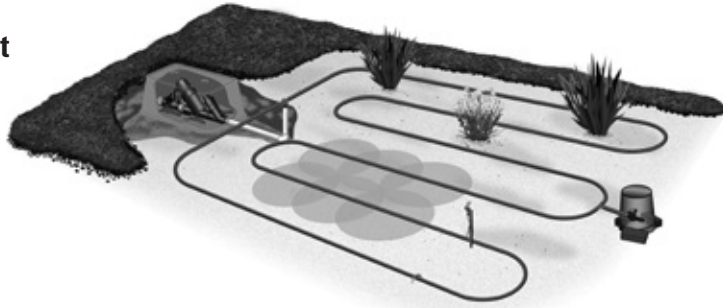

### BASIC LITE LAYOUT:

- Water being supplied to the zone is split with a Techline 17mm fitting into two directions. Use a Techline Combination Tee fitting (TL075FTEE) or 3/4" MPT x "V" fitting (TL2W075MA).
- Weave the Techline back and forth throughout the planting area with evenly spaced rows.
- Indent the tubing 2" - 4" from hardscapes and planting areas.
- Because water is being split into two separate paths that meet in the middle, the maximum length of the lateral can be twice the stated limit in Table 2: Maximum Length of a Single Lateral (see page 9).
- Therefore, to determine the maximum amount of Techline you can use in the zone, simply double the maximum length stated in Table 2: Maximum Length of a Single Lateral (see page 9).

### Calculating Equal Row Spacing

#### Example:

- $5' \times 12" = 60"$
- $60" - 8" (2 \text{ edges} \times 4" \text{ setback}) = 52"$
- Following recommended Techline HCVXR and CV Row Spacing for this example, assume 18" from Table 1
- $52" \div 18" = 2.89$  spaces between Techline rows
- Round up 2.89 to the next whole number, which is 3 (spaces)
- Add 1 (one) to the number of spaces to determine the number of Techline rows
- Determine equal spacing between Techline rows:  $52" \div 3 = 17.3"$

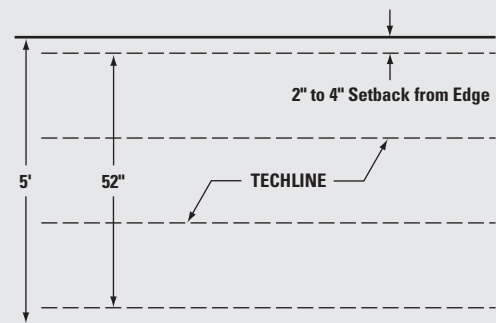

#### NOTE

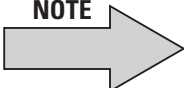

**HOW TO QUICKLY DETERMINE THE AMOUNT OF TECHLINE IN A ZONE**  
**(Square Footage of Zone x 12) ÷ Minimum Recommended Row Spacing**

# NETAFIM TECHLINE® HCVXR and CV DESIGN GUIDE

## BASIC DESIGN STEPS (CONTINUED)

### LENGTH OF TECHLINE ROWS:

- As with overhead irrigation, friction losses through pipe determine how long a length of pipe can be.
- You do not need to go through friction loss calculations for Techline HCVXR and CV laterals. It has already been done for you.
- Table 2 shows the maximum length of a single Techline lateral within a zone.
- The table also determines what the operating pressure of the zone needs to be.

**Example:** If you have a 295' lateral of 0.6 GPH/12" Techline CV, it will need 35 psi to operate properly. If it is from 296' - 340', it will need 45 psi.

**Note:** We will discuss how to regulate your pressure in the Pressure Regulating Valve section (see page 17).

- Once the zone is laid out, note the pressure you will need somewhere on the design. You will need this information later to size the Pressure Regulating Valve.

**TABLE 2: MAXIMUM LENGTH OF A SINGLE LATERAL (FEET)**

#### TECHLINE HCVXR

EMITTER SPACING		12"				18"				24"	
EMITTER FLOW (GPH)		0.33	0.53	0.77	1.16	0.33	0.53	0.77	1.16	0.77	1.16
INLET PRESSURE	25 psi	237	173	136	103	335	246	192	146	244	184
	30 psi	327	240	187	142	464	341	266	203	338	258
	35 psi	385	282	221	168	546	401	314	239	400	304
	40 psi	429	315	247	187	611	449	351	267	446	340
	45 psi	467	342	268	203	663	488	381	290	486	370
	50 psi	499	366	287	218	710	521	408	311	520	396
	55 psi	528	387	303	230	752	552	432	329	550	418
	60 psi	554	406	318	241	788	579	453	345	578	440

#### TECHLINE CV

EMITTER SPACING		12"				18"				24"	
EMITTER FLOW (GPH)		0.26	0.4	0.6	0.9	0.26	0.4	0.6	0.9	0.6	0.9
INLET PRESSURE	20 psi	331	242	190	144	468	344	270	204	342	260
	25 psi	413	302	238	180	584	429	338	257	430	326
	35 psi	518	380	299	227	737	540	426	323	542	412
	45 psi	594	436	343	260	845	620	489	371	622	472
	55 psi	655	480	378	287	932	684	539	410	686	522
	60 psi	681	500	393	298	969	713	561	426	716	544

## BASIC DESIGN STEPS (CONTINUED)

### CENTER FEED GRID LAYOUT:

- You can increase the length of laterals by center-feeding the zone. By doing so, you can have a length of Techline as called out in Table 2: Maximum Length of a Single Lateral, going in each direction, effectively doubling the maximum lateral length. This is just like we discussed with the LITE layout (see page 8).
- Where layout flexibility exists, Center Feed layout is an excellent design method.
- It allows for the most even flow of water through the zone.
- It is an excellent option for median strips and other large, homogenous areas.

### Center Feed Layout

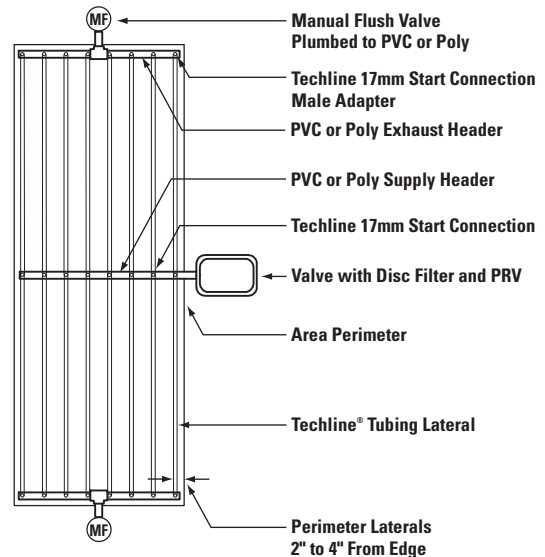

### OTHER GRID LAYOUT CONSIDERATIONS:

- When branching out or joining rows of Techline HCVXR or CV, one of two rules apply:  
 Rule #1: When branching out Techline from the supply header, add up all "branched out" dripline and check it against the maximum lateral length listed in Table 2: Maximum Length of a Single Lateral.  
 Rule #2: When joining laterals from the supply header, check only the longest lateral against the maximum allowable in Table 2: Maximum Length of a Single Lateral.

### Branching Out Laterals

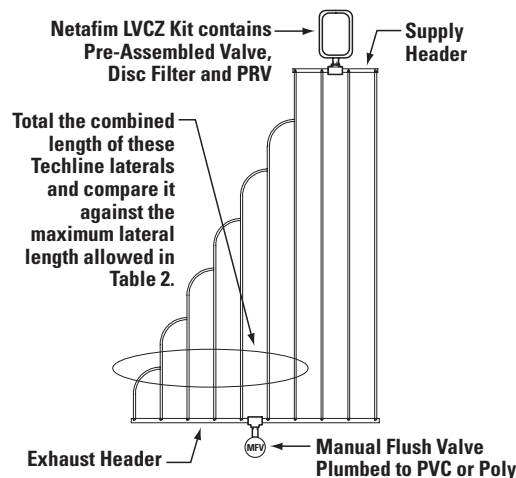

### Joining Laterals

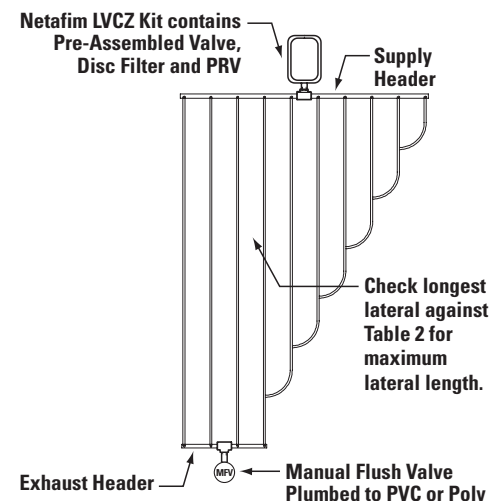

# NETAFIM TECHLINE® HCVXR and CV DESIGN GUIDE

## BASIC DESIGN STEPS (CONTINUED)

### CREATING SUB-HEADERS TO REDUCE GLUE/SADDLE JOINTS

- To reduce the number of glue joints, saddles or insert fittings in a header, transition to Techline HCVXR and CV and Techline fittings to make up subheaders.
- Make sure to follow the guideline of not exceeding 5 GPM in the 'sub-header' zone.

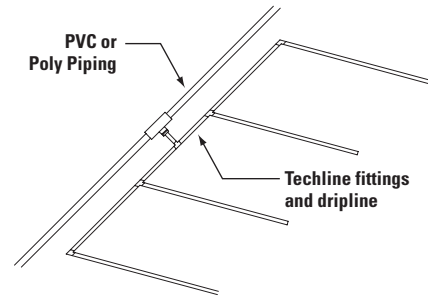

### ZONE WATER REQUIREMENTS:

- Once the Techline is laid out, we need to identify total zone flow. This will help determine mainline and submain as well as supply and exhaust header sizing, valve, filter, and pressure regulator selection.
- Because Techline HCVXR and CV are pressure compensating, the flow rate per 100' is the same over a wide pressure range.
- There are two ways to determine the flow in a Techline zone using the calculation chart on page 12 or Table 3: Flow per 100 Feet below.
- Table 3: Flow per 100 Feet, shows an easy way to determine total zone flow:
  - Add up the amount of Techline (in hundreds of feet) and
  - Multiply that figure by the corresponding dripline GPM to determine zone flow.

**TABLE 3: FLOW PER 100 FEET**

#### TECHLINE HCVXR

EMITTER SPACING	0.33 EMITTER		0.53 EMITTER		0.77 EMITTER		1.16 EMITTER	
	GPH	GPM	GPH	GPM	GPH	GPM	GPH	GPM
12"	33.0	0.55	53.0	0.88	77.0	1.28	116.0	1.93
18"	22.0	0.37	35.3	0.59	51.3	0.86	77.3	1.29
24"	16.5	0.28	26.5	0.44	38.5	0.64	58.0	0.97

#### TECHLINE CV

EMITTER SPACING	0.26 EMITTER		0.4 EMITTER		0.6 EMITTER		0.9 EMITTER	
	GPH	GPM	GPH	GPM	GPH	GPM	GPH	GPM
12"	26.4	0.44	42.3	0.71	60.8	1.01	92.5	1.54
18"	17.6	0.29	28.2	0.47	40.5	0.68	61.6	1.03
24"	-	-	-	-	30.4	0.51	46.2	0.77

## **BASIC DESIGN STEPS** (CONTINUED)

### **Calculating Total Zone Water Demand**

- Multiply Total Feet x 12" = Total inches of Techline
- Total Inches of Techline ÷ Emitter Spacing = Number of Emitters
- Multiply Number of Emitters x Emitter Flow Rate (GPH) = Total GPH Flow
- Total GPH Flow ÷ 60 = Total GPM in the Zone

#### **Example:**

**Ten 100' rows of Techline with Emitter Spacing of 18", Flow Rate is 0.6 GPH.**

$$100' \times 10 = 1,000'$$

$$1,000' \times 12" = 12,000" \quad 12,000" \div 18" = 667 \text{ Emitters}$$

$$667 \text{ Emitters} \times 0.61^* \text{ GPH} = 407 \text{ GPH Total Flow}$$

$$407 \text{ GPH} \div 60 = 6.78 \text{ GPM Flow in the Zone}$$

\*0.61 is the actual flow rate of the 0.6 GPH emitter and should be used in calculations for greatest accuracy.

# NETAFIM TECHLINE® HCVXR and CV DESIGN GUIDE

## BASIC DESIGN STEPS (CONTINUED)

### FITTINGS:

When laying out Techline HCVXR or CV, you will need to use fittings. If you have chosen a GRID layout, you may need a transition fitting from the supply piping to the Techline laterals. Further, you will use Techline 17mm fittings to connect the rows of Techline to the headers. If you are using a LITE layout, you will also use a transition fitting from the supply piping, as well as a fitting at the end or midpoint of the zone so that a flush point can be installed.

Netafim 17mm barbed insert fittings are designed to speed the installation as well as offer you a broad range of choices. The barbed end(s) of all Techline fittings is raised and sharp. This allows the fitting to be used with operating pressures up to 58 psi.

Fittings are simply pressed into the tubing. No special tools are required. As with all polyethylene pipe, do not heat the tubing before inserting the fittings. It is not necessary and it can damage the pipe.



**3/4" Male  
Adapter**  
TL075MA



**1/2" Male  
Adapter**  
TL050MA



**Insert Adapter for  
1" or Larger PE**  
TLIAPE



**Insert Adapter for  
1 1/2" or Larger PVC**  
TLIAPVC



**Insert Coupling**  
TLCOUP



**Insert Elbow**  
TELL



**Insert Tee**  
TLTEE



**Insert Cross**  
TLCROS



**Combination Tee**  
Ins. x Ins. x 3/4" FPT  
TL075FTEE



**3/4" MPT x 'V'**  
TL2W075MA



**Figure 8 Line End**  
TLFIG8

## BASIC DESIGN STEPS (CONTINUED)

### STAPLES:

Techline staples (TLS6) are used to hold dripline in place. While most commonly used when Techline is laid on-surface or under a mulch cover, staples are also valuable when a layout is being assembled sub-grade before being covered with dirt.



**Rule of Thumb:** Use a minimum of one staple for every:

- 3 feet of dripline in sand
- 4 feet of dripline in loam
- 5 feet of dripline in clay

Further, use 2 staples 'x'ed' over each other with any change-of-direction fittings such as tees, elbows or crosses.

- Use a rounded staple so as not to pinch tubing during installation.

### LINE FLUSHING VALVES:

Techline HCVXR and CV has a check valve in each emitter designed to hold back a 8.5' or 4.6' column of water (3.64 psi and 2 psi emitter closing pressure). Therefore, it may not be desirable to use an automatic flush valve with Techline HCVXR and CV, since it could allow water to drain from the dripline after zone shutdown.

- Line flushing valves are used to provide a cleansing action in dripline each time the zone is turned on.
- When the zone is turned on, the flush valve begins dumping water into a sump located under it.
- The dumping of water (additional flow) allows the velocity of water inside the dripline to increase momentarily helping to clean the inside walls of the tubing.
- This action moves sediments out of the zone and into the sump.

### IF AN AUTOMATIC FLUSH VALVE IS NOT DESIRED:

- It is because holding the water in the Techline is desired and,
- Procedures have been established to manually flush the lines during the season.
- In this case, Manual Flush Valves (TLSOV) or Figure 8 Line Ends (TLFIG8) should be located along the exhaust header, or at the midpoint of a LITE layout.



Manual Flush Valve  
TLSOV

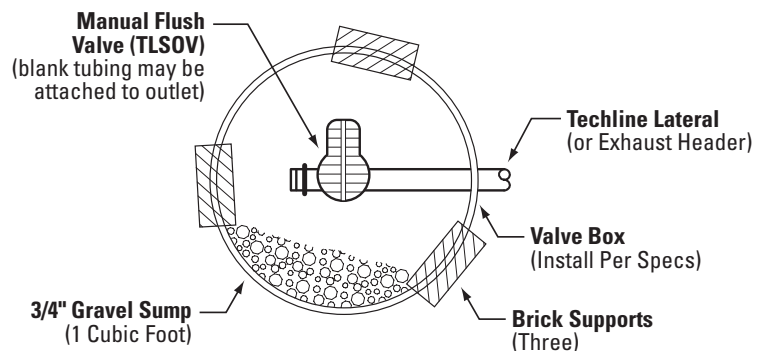

## BASIC DESIGN STEPS (CONTINUED)

### IF AN AIR/VACUUM RELIEF VENT IS DESIRED:

Because Techline HCVXR and CV is designed to keep water in the tubing, an air/vacuum relief vent (TLAVRV) would only be used in conjunction with an Automatic Flush Valve as described in the previous section.

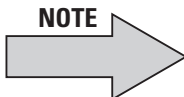

If you want to hold the water inside the dripline after zone shutdown, (you are using a TLSOV or TLFIG8 in lieu of an Automatic Flush Valve) **DISREGARD THIS SECTION.**

An air/vacuum relief vent (TLAVRV) freely allows air into a zone after shutdown. It also ensures a vacuum doesn't draw debris into the dripline. Further, they also provide a means of releasing air from the dripline when the zone is turned on, thus eliminating air pockets and speeding up dripline operation. *(Because water stays in a Techline HCVXR and CV zone anytime the elevation across the zone is less than 8.5' and 4.6', this is not an issue).*

- On zones where an air/vacuum relief vent is desired, they are installed at the highest point(s) in the zone.
- To ensure that all of the rows of the dripline can take advantage of the air/vacuum relief vent, **install it/them along a lateral that runs perpendicular to the dripline laterals.** This may be an exhaust header, or a special lateral connecting all the rows of dripline, such as going over a berm.

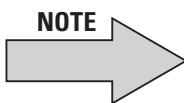

In large scale irrigation systems where pumps and large diameter pipe are used, air that has been created must be expelled. As such, the use of continuous air vents may be required on continuously and non-continuously pressurized lines.



Air/Vacuum Relief Vent - 1/2" MPT TLAVRV

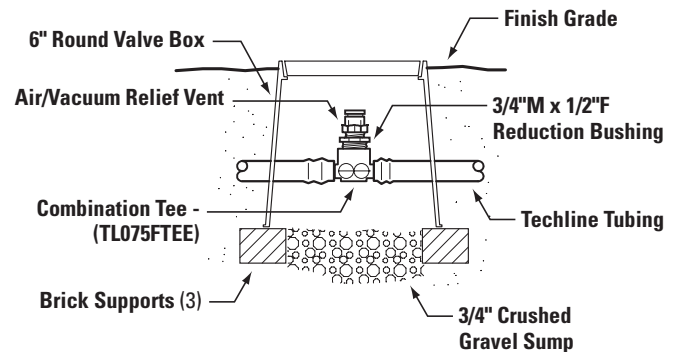

### Installing Air/Vacuum Relief Valve to Laterals

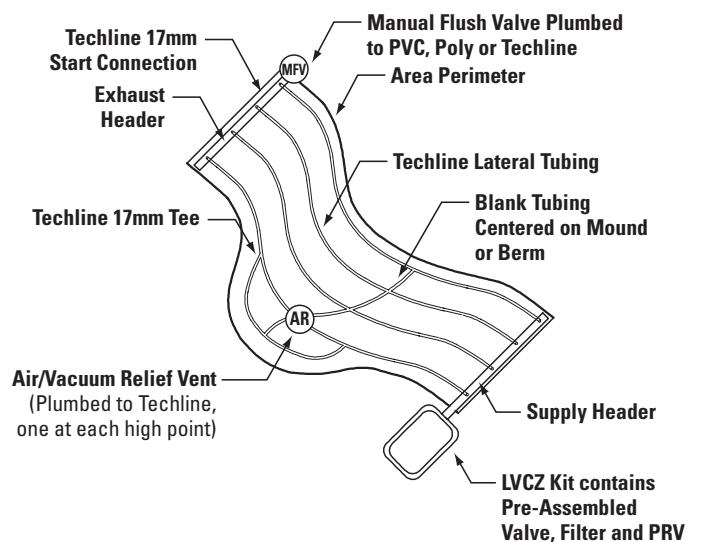



# NETAFIM TECHLINE® HCVXR and CV DESIGN GUIDE

## BASIC DESIGN STEPS (CONTINUED)

### FILTERS:

- Just like overhead irrigation, dripline needs protection against dirt and debris. (In sprinkler heads, filters are placed under the drive assembly or nozzle). With dripline, one filter is placed at the beginning of the zone, or at the point of connection (POC).
- Filters are normally installed immediately downstream of the remote control valve.
- Netafim disc filters use an overlapping series of grooved discs that force water to move through a series of trap points. The depth created by stacked discs captures more debris than screen filters.
- The disc filter elements are easily removed from the filter body and flushed clean under a faucet or in a pail of clean water.
- **Rule of Thumb:** Techline HCVXR and CV only require 120 mesh filtration. Finer mesh is not necessary and may require more frequent cleaning.
- Refer to Table 4, Disc Filter Sizing Chart below to properly size the filter.



**TABLE 4: DISC FILTER SIZING CHARTS**

#### TECHLINE HCVXR

		12" DRIPPER SPACING				18" DRIPPER SPACING				24" DRIPPER SPACING			
DRIPPER FLOW RATE		0	1	1	1	0	1	1	1	0	1	1	1
3/4"	Minimum 1.00 GPM	182	114	79	52	273	171	118	78	364	228	157	104
	Maximum 12.00 GPM	2,182	1,364	941	620	3,273	2,046	1,411	930	4,364	2,728	1,881	1,240
1"	Minimum 5.00 GPM	910	569	392	259	1,364	853	588	388	1,819	1,137	784	517
	Maximum 26.00 GPM	4,728	2,955	2,038	1,343	7,091	4,432	3,057	2,015	9,455	5,910	4,076	2,686
1" or 1 1/2" Long	Minimum 10.00 GPM	1,819	1,137	784	517	2,728	1,705	1,176	775	3,637	2,273	1,568	1,034
	Maximum 35.00 GPM	6,364	3,978	2,743	1,808	9,546	5,966	4,115	2,712	12,728	7,955	5,486	3,616
2"	Minimum 40.00 GPM	7,273	4,546	3,135	2,067	10,910	6,819	4,703	3,100	14,546	9,091	6,270	4,133
	Maximum 110.00 GPM	20,000	12,500	8,621	5,682	30,000	18,750	12,932	8,523	40,000	25,000	17,242	11,364

#### TECHLINE CV

		12" DRIPPER SPACING				18" DRIPPER SPACING				24" DRIPPER SPACING			
DRIPPER FLOW RATE		0.26	0.42	0.61	0.92	0.26	0.42	0.61	0.92	0.26	0.42	0.61	0.92
3/4"	Minimum 1.00 GPM	228	142	99	65	341	213	149	98	455	284	198	130
	Maximum 12.00 GPM	2,728	1,703	1,185	779	4,091	2,554	1,777	1,169	5,455	3,405	2,369	1,558
1"	Minimum 5.00 GPM	1,137	710	494	325	1,705	1,064	741	487	2,273	1,419	987	649
	Maximum 26.00 GPM	5,910	3,688	2,566	1,688	8,864	5,532	3,849	2,531	11,819	7,376	5,132	3,375
1" or 1 1/2" Long	Minimum 10.00 GPM	2,273	1,419	987	649	3,410	2,128	1,481	974	4,546	2,837	1,974	1,298
	Maximum 35.00 GPM	7,955	4,965	3,454	2,272	11,932	7,447	5,181	3,407	15,910	9,930	6,908	4,543
2"	Minimum 40.00 GPM	9,091	5,674	3,948	2,596	13,637	8,511	5,922	3,894	18,182	11,348	7,895	5,192
	Maximum 110.00 GPM	25,000	15,603	10,856	7,139	37,500	23,405	16,283	10,708	50,000	31,206	21,711	14,277

## BASIC DESIGN STEPS (CONTINUED)

### PRESSURE REGULATING VALVES (PRV):

Pressure regulating valves reduce the operating pressure so that Techline zones operate between 14 to 58 psi for Techline CV and 21.8 to 58 psi for Techline HCVXR.

- PRVs are normally installed immediately downstream of the disc filter and control valve. Often all three components are in the same valve box, and the distance from the PRV to the Techline is limited so additional friction is not incurred.
- The two most popular sizes of PRV are both 3/4" units. One is a low flow version that has a flow range of 0.25 - 4.4 GPM. The high flow version has a flow range of 4.5 - 17.6 GPM. Other sizes from 1 1/2" - 3" are also available for zones with flows up to 200 GPM.

### SELECTING THE CORRECT PRV

- To select the correct PRV, choose the model with the correct flow range based on total zone flow.
- Then select the correct pressure rating based on the following:
  1. If you used Table 2: Maximum Length of a Single Techline HCVXR and CV Lateral, match the PRV to the same pressure rating you used for your maximum lateral length calculation, **OR**
  2. Simply use a 45 psi PRV. Because Techline HCVXR and CV are pressure compensating, there is no reason to intentionally reduce the pressure below 45 psi.



### NOTES:

1. If the PRV is remotely located from the supply header, remember to account for any friction loss that occurs through the piping to the supply header.
2. Refer to Pressure Regulator sizing chart on page 18.
3. Low Volume Control Zone kits speed installation and have all of the components needed for a low volume zone. Kits are sized for a specific flow range.

### PRESSURE REGULATOR VALVES FLOW RANGES

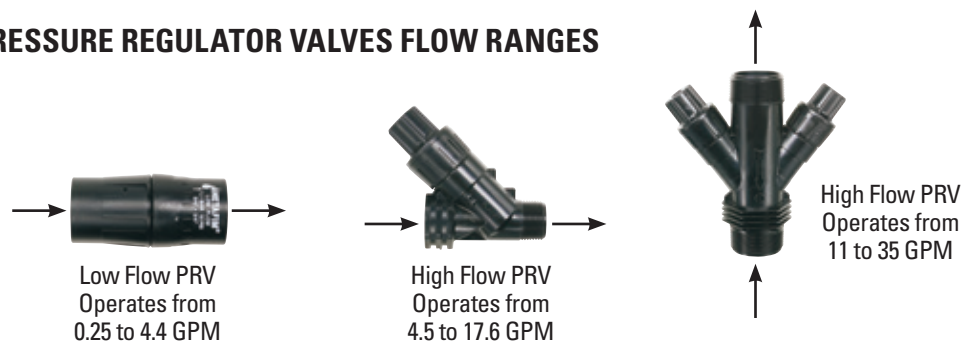

# NETAFIM TECHLINE® HCVXR and CV DESIGN GUIDE

**BASIC  
DESIGN  
STEPS**  
(CONTINUED)

**TABLE 5: PRESSURE REGULATOR SIZING CHARTS**

**TECHLINE HCVXR MINIMUM AND MAXIMUM LENGTH**

EMITTER FLOW RATE (GPH)		TECHLINE HCVXR EMITTER SPACING (IN FEET)											
		12"				18"				24"			
		0.33	0.53	0.77	1.16	0.33	0.53	0.77	1.16	0.33	0.53	0.77	1.16
3/4" LOW FLOW PRESSURE REGULATOR	MINIMUM 0.25 GPM	46	29	20	13	69	43	30	20	91	57	40	26
	MAXIMUM 4.40 GPM	800	500	345	228	1,200	750	518	341	1,600	1,000	690	455
3/4" HIGH FLOW PRESSURE REGULATOR	MINIMUM 4.50 GPM	819	512	353	233	1,228	768	529	349	1,637	1,023	706	465
	MAXIMUM 17.60 GPM	3,200	2,000	1,380	910	4,800	3,000	2,069	1,364	6,400	4,000	2,759	1,819
1 1/2" PRESSURE REGULATOR	MINIMUM 11.00 GPM	2,000	1,250	863	569	3,000	1,875	1,294	853	4,000	2,500	1,725	1,137
	MAXIMUM 35.00 GPM	6,364	3,978	2,743	1,808	9,546	5,966	4,115	2,712	12,728	7,955	5,486	3,616

**TECHLINE CV MINIMUM AND MAXIMUM LENGTH**

EMITTER FLOW RATE (GPH)		TECHLINE CV EMITTER SPACING (IN FEET)											
		12"				18"				24"			
		0.26	0.4	0.6	0.9	0.26	0.4	0.6	0.9	0.26	0.4	0.6	0.9
3/4" LOW FLOW PRESSURE REGULATOR	MINIMUM 0.25 GPM	57	36	25	17	86	54	38	25	114	71	50	33
	MAXIMUM 4.40 GPM	1,000	625	435	286	1,500	937	652	429	2,000	1,249	869	572
3/4" HIGH FLOW PRESSURE REGULATOR	MINIMUM 4.50 GPM	1,023	639	445	293	1,535	958	667	439	2,046	1,277	889	585
	MAXIMUM 17.60 GPM	4,000	2,497	1,737	1,143	6,000	3,745	2,606	1,714	8,000	4,993	3,474	2,285
1 1/2" PRESSURE REGULATOR	MINIMUM 11.00 GPM	2,500	1,561	1,086	714	3,750	2,341	1,629	1,071	5,000	3,121	2,172	1,428
	MAXIMUM 35.00 GPM	7,955	4,965	3,454	2,272	11,932	7,447	5,181	3,407	15,910	9,930	6,908	4,543

# NETAFIM TECHLINE® HCVXR and CV DESIGN GUIDE

## BASIC DESIGN STEPS (CONTINUED)

### LOW VOLUME CONTROL ZONE KITS:

- These preassembled kits speed installation and have all of the components needed for a low volume zone.
- Kits are sized for a specific flow range

### LOW VOLUME CONTROL ZONE (LVCZ Kit) - LOW FLOW WITH DISC FILTER

- Netafim Series 80 1" Valve (LVET1GH2)
- Netafim Disc Filter (DF075-140)
- Netafim PRV (PRV075LF42V2K)
- For zones ranging from 0.25 - 4.4 GPM



### LOW VOLUME CONTROL ZONE (LVCZ Kit) - HIGH FLOW WITH DISC FILTER

- Netafim Series 80 1" Valve (LVET1GH2)
- Netafim Disc Filter (DF075-140)
- Netafim PRV (PRV075HF57V2K)
- For zones ranging from 4.5 - 17.6 GPM



### LOW VOLUME CONTROL ZONE (LVCZ Kit) - HIGH FLOW 1 1/2" WITH DISC FILTER

- Netafim Series 80 1 1/2" Valve (LVET1.5GH2)
- Netafim Disc Filter (DF150-140)
- Netafim PRV (PRV075HF57V2K)
- For zones ranging from 11 - 35 GPM

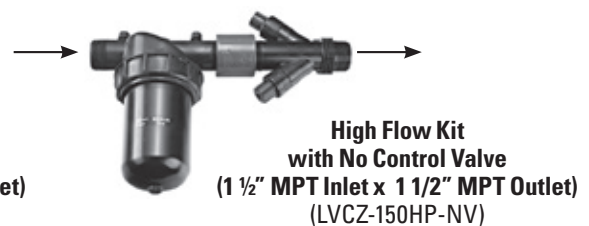
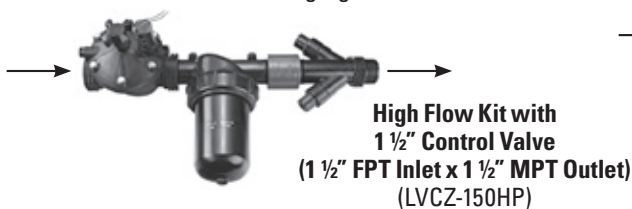

# NETAFIM TECHLINE® HCVXR and CV DESIGN GUIDE

## BASIC DESIGN STEPS (CONTINUED)

### LOW VOLUME CONTROL ZONE (LVCZ Kit) - LOW FLOW WITH SCREEN FILTER

- Netafim Series 80 1" Valve (LVET1GH2)
- Netafim Screen Filter (SF075-155)
- Netafim PRV (PRV075LF42V2K)
- For zones ranging from .25 - 4.4 GPM



**Low Flow Kit  
with 1" Control Valve  
(1" FPT Inlet X 3/4" FPT Outlet)  
(LVCZS80SF10075-LF)**



**Low Flow Kit  
with No Control Valve  
(3/4" MPT Inlet x 3/4" FPT Outlet)  
(LVCZNVSF10075-LF)**

### LOW VOLUME CONTROL ZONE (LVCZ Kit) - HIGH FLOW WITH SCREEN FILTER

- Netafim Series 80 1" Valve (LVET1GH2)
- Netafim Screen Filter (SF075-155)
- Netafim PRV (PRV075HF57V2K)
- For zones ranging from 4.5 - 17.6 GPM



**High Flow Kit  
with 1" Control Valve  
(1" FPT Inlet x 3/4" MPT Outlet)  
(LVCZSF10075-HFHP)**



**High Flow Kit  
with No Control Valve  
(3/4" MPT Inlet x 3/4" MPT Outlet)  
(LVCZNVSF10075-HFHP)**

### LOW VOLUME CONTROL ZONE (LVCZ Kit) - HIGH FLOW 1 1/2" WITH SCREEN FILTER

- Netafim Series 80 1 1/2" Valve (LVET1.5GH2)
- Netafim Screen Filter (SF150-155)
- Netafim PRV (PRV075HF57V2K)
- For zones ranging from 11 - 35 GPM



**High Flow Kit  
with 1 1/2" Control Valve  
(1 1/2" FPT Inlet x 1 1/2" MPT Outlet)  
(LVCZSF-150HP)**



**High Flow Kit  
with No Control Valve  
(1 1/2" MPT Inlet x 1 1/2" MPT Outlet)  
(LVCZSF-150HP-NV)**

# NETAFIM TECHLINE® HCVXR and CV DESIGN GUIDE

## BASIC DESIGN STEPS (CONTINUED)

### SLOPES AND BERMS:

Techline HCVXR and CV emitters have a built-in check valve. This allows Techline HCVXR to hold back up to a 8.5' and Techline CV up to 4.6 column of water. As such, designing Techline HCVXR and CV on slopes and berms is very easy.

- Techline HCVXR and CV should be installed perpendicular to (across) slopes.
- In the upper 2/3 of the slope, space Techline HCVXR and CV per Table 1, page 6.
- In the lower 1/3 of the slope, increase the distance between rows by 25%.
- For every 4.6 feet of elevation change, when using Techline CV either:
  - Split the slope into separate zones, or
  - Install a Netafim in-line check valve (TLCV050M1).
- For every 8.5 feet of elevation change, when using Techline HCVXR either:
  - Split the slope into separate zones, or
  - Install a Netafim in-line check valve (TLCV050M1).

### Taller Slope Irrigation Method

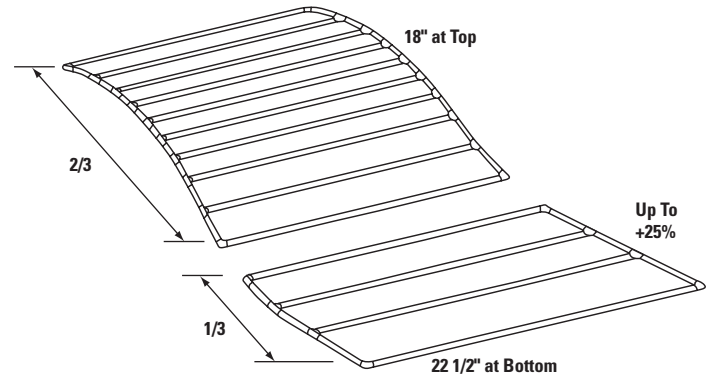

### IN-LINE CHECK VALVE (TLCV050M1):

- Designed to hold back up to a 13.4' column of water
- **Rule of Thumb:** Every 1' of water exerts 0.433 psi of pressure at the base of the column. As such, a 100' column of water exerts 43.3 psi at the base.

#### Specifications:

- Flow Range: 0.9 - 4.4 GPM (54 - 264 GPH)
- Closing Pressure: 5.8 psi
- Opening Pressure: 10.2 psi
- Can hold back a 13.4' column of water ( $5.8 \div 0.433$ )
- Connection: 1/2" MPT



In-Line Check Valve  
1/2" MPT  
TLCV050M1-B

## BASIC DESIGN STEPS (CONTINUED)

### TREES:

It is important to provide trees with adequate water at the rootball, while also planning for the tree's needs as it grows.

**NOTE:** When trees are transplanted, the soil in the rootball and the native soil are different. You must ensure that there are sufficient emitters irrigating both soils because water will not migrate from one soil type to the other.

- A loop of Techline close to the rootball, with more Techline surrounding the estimated dripline of the tree when mature will provide sufficient water.

### Techline Tubing and Components for Tree Planting

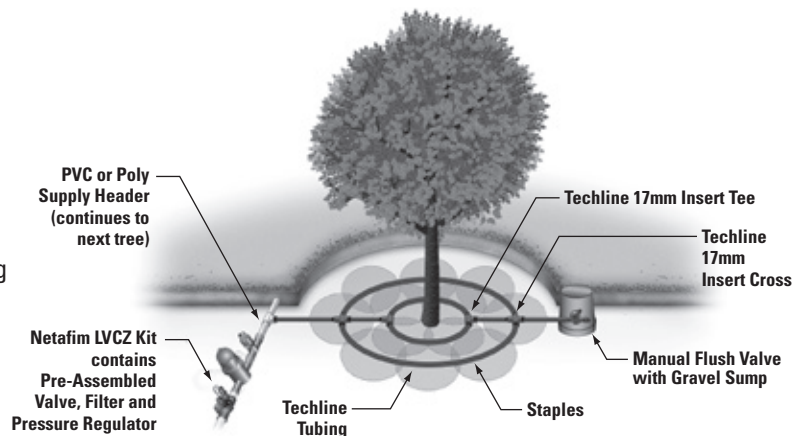

### PRESSURE AND FLOW CHECKS:

- One of the best means of ensuring a Techline zone is operating properly is to test the pressure at regular intervals.
- By measuring and recording the pressure while the zone is running, you can ensure that the zone is working as installed.
- Take the reading as far away from the source as possible to ensure that pressures throughout the rest of the zone are at least that high.
- If readings are lower than normal, a line break, clogged filter, dirty valve, clogged PRV, or reduced line pressure are possible causes.

#### NOTE



**NOTE:** Always take the readings at the same time of day, from the same spot. This reduces the chance of faulty readings due to other factors.

- If a water meter is available, check the flow of each zone.
- Record the information at least once per year on a System Inspection Checklist (an example is provided on page 40).

### CALCULATING PRECIPITATION RATES:

- **Method 1:** See the Techline HCVXR and CV Application Rate Tables on pages 33 and 34.
- **Method 2:** If there is some variation in your design, (for instance, when we had to decrease the distance between the rows in our earlier example) then use Formula 1.2 on page 30.

**CAUTION:** Though the precipitation rates of rotors, fixed sprays and Techline can be very close in many situations, we do not recommend tying dripline into spray or rotor zones. Techline HCVXR and CV have an irrigation application rate efficiency greater than sprays or rotors. Even when calculations make it appear that the application rates are the same, a Techline zone will actually be delivering more water since none of it is evaporating or landing where it can't be used.

## TECHLINE HCVXR AND CV IN TURF

### TECHLINE HCVXR AND CV IN TURFGRASS:

**Background:** Netafim products have been used successfully in turfgrass since the 1980's. It is a popular choice for a variety of residential and commercial general-use and specialized-use turf areas, and has been used very successfully in sports turf, as well as composition and grass tennis courts.

### WHERE AND WHY TO USE TECHLINE IN TURF:

- Long, odd-shaped or narrow areas:
  - Allows greater landscape design freedom to use curvilinear layouts that cannot be utilized when overhead irrigation is used
  - Eliminates wet roads and sidewalks
  - Helps save water
  - Reduces slipping and tripping hazards
  - Reduces wet surface hazards to vehicle traffic
  - The ability to irrigate areas with less water in long narrow areas where either getting the water is hard, or zoning the area is difficult
  - Overspray is eliminated
- Areas close to buildings and at-grade windows:
  - Stops windows from getting wet
  - Allows the use of turfgrass close to a building without damage to facades
  - Reduces deterioration and discoloration of building facades
- Athletic fields:
  - No exposed sprinklers reduces impact injuries
  - On tight-soil fields:
    - Can be irrigated and softened prior to play without wetting the surface
    - Helps reduce impact injuries from hard soil surfaces
  - Because water window issues are eliminated, time of play increases
- Auto dealerships and other parking areas:
  - No overspray reduces the cost of auto detailing
  - Reduces slipping and tripping hazards
  - Reduces wet surface hazards to vehicle traffic
- High wind, or constant wind areas:
  - Overspray and wasted water is eliminated
  - Water gets where it is supposed to be regardless of wind
- High liability areas:
  - Tripping and other liability issues are significantly reduced
  - Maintenance costs to repair broken sprinkler heads are greatly reduced
- Vandal-prone areas:
  - Out of sight, out of mind
  - Maintenance costs and potential liability of unrepaired problems is greatly reduced



## TECHLINE HCVXR AND CV IN TURF

- Wood hardscapes:
  - Bleaching of hardscapes such as wooden fences is eliminated
  - Aesthetics of the wood hardscapes is maintained
- Steep slopes:
  - Allows turf to be used on slopes
  - Water is easily managed on slopes with dripline
  - Wash outs are eliminated
- Locales where the cost of water is too expensive for overhead irrigation
- Unlike spray or rotor irrigation, which does not have an even application rate across its pattern, Techline HCVXR and CV have an extremely well-balanced application rate in the entire area. As such, you do not need to overwater to make sure the driest area receives enough water.
  - Techline HCVXR and CV use about half of the water of an overhead system
  - Techline HCVXR and CV are about 90% efficient vs. overhead irrigation, which is about 60% efficient
- Water window issues:
  - Irrigate whenever necessary because there is no exposed spray
- Recycled/reclaimed water or fertigation applications where spraying water is illegal:
  - Allows for use of nutrient-rich water, often at a greatly reduced cost
  - Saves potable water supplies

### TIPS FOR USING TECHLINE HCVXR AND CV IN A NEWLY-SODDED LAWN:

- Use Table 1: General Guidelines recommendations for turf, see page 6.
- Bury the Techline approximately 4" below final grade
- In areas where mechanical aeration will be used, bury the Techline 6" below final grade and ensure aeration does not exceed 4"
- When installing the sod:
  - It is important the final grade is smooth, ensuring that the sod makes solid contact with the soil
  - Properly 'knit' the edges together
  - Thoroughly wet the sod with overhead irrigation
  - Roll the sod to ensure good contact
- If the irrigation system is automatic:
  - Set the zone to run several times daily
  - Keep wetted from above as necessary until the roots establish
- Once you cannot pull the edges of the sod up, discontinue overhead watering
- Irrigate on a daily or every-other-day basis
- Techline HCVXR and CV have a patented emitter design with a built-in physical root barrier in each emitter
- Techline HCVXR offers additional root intrusion protection with Cupron® copper oxide which is embedded in the emitter resin during the manufacturing process. It will not wash off, wear off or leach out of the emitter for long lasting root intrusion protection throughout the life of the dripline.

## SPECIAL APPLICATIONS AND TIPS

### PARKING LOT ISLANDS:

If islands are small, consider tying several of them together on the same zone.

- Once you have determined that the conditions of the islands are similar enough to interconnect them, design each for the same precipitation rate by using the same Techline HCVXR and CV and spacing.
- Use one Low Volume Control Zone kit at the source, and install a manual flush valve (TLSOV) or figure 8 line end (TLFIG8) either at the end of the last island or, if the islands dead-end, on each island.
- Connections between the islands should be PVC, or as called out by the designer or local codes.

### ELECTRICAL GROUNDING:

- The effectiveness of electrical grounding is dependent on the soil and its moisture content. In moist soil, grounding is more effective than in dry soil.
- One method of ensuring moist soil is to install a length of Techline HCVXR and CV along a length of unclad copper wire being used for grounding purposes. The Techline HCVXR and CV are installed in the usual method. Run it from a separate station on the controller to give you maximum control.
- Techline HCVXR and CV can also be installed over the top of a grounding plate or ground rod.

### ABOVE AND BELOW GRADE:

Techline HCVXR and CV are designed to be used in a variety of ways:

- It can be laid on the surface and held in place with Techline staples (TLS6),
- It can be buried below grade.

#### NOTE

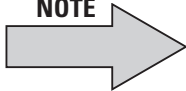

**NOTE:** When using Techline HCVXR and CV above grade with staples, use enough staples to firmly hold the tubing in place, especially in freezing climates.

## TECHLINE HCVXR AND CV WINTERIZING INSTRUCTIONS

### WINTERIZING INSTRUCTIONS:

Winterizing an irrigation system involves removing enough water to ensure that components do not crack or break during freezing weather.

Because Techline HCVXR and CV are designed to keep water sealed inside the tubing between irrigations, it is important that these simple steps be followed.

### MANUAL WINTERIZATION (no compressed air blow-out)

- A drain port must be present at all low points in the zone.
- Ports may be a tee or elbow with a threaded plug, a Netafim figure 8 line end (TLFIG8) or manual flush valve (TLSOV) which, when opened, will allow water to drain. If a Netafim automatic flush valve has been used, disassemble it.
- If the Techline zone is a grid or closed system, the supply and exhaust headers may contain a significant amount of water because they are either blank Techline tubing, PVC, or poly pipe. It is important to provide drain ports for these components.
- If the Techline laterals dead-end, and are not connected to an exhaust header, the lateral ends should be opened to drain at the lowest point(s).
- In the event that some water remains in the system, the disc filter should be disassembled, and the discs removed to allow any water to exit. Leave the filter disassembled in the event that some water remains in the system.
- In systems where elevation is a concern, install a drain port upstream of the filter to ensure as much water as possible is drained.
- Follow manufacturer instructions for any automatic zone valves.

### COMPRESSED AIR WINTERIZATION

Follow the same initial procedures for a Techline HCVXR and CV zone as you would for a zone of overhead sprinklers.

#### NOTE

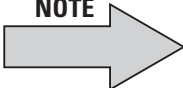

**Note:** Techline HCVXR and CV fittings are rated to 58 psi, so the air pressure must be adjusted according. It is air volume, not pressure that is effective when winterizing in this manner.

- The pressure regulator, which is normally installed in the valve box along with the zone valve and filter regulates water, not air pressure. Air pressure should be regulated to 58 psi or less.
- The drain ports, (a fitting with a threaded plug, a Netafim TLISOV, TLFIG8, or automatic flush valve), which are normally installed as far away from the water source of the zone as possible, must be open. Unscrew and disassemble any automatic flush valves.
- With all drain ports open, compressed air should be applied until no water is seen exiting the zone.

# NETAFIM TECHLINE® HCVXR and CV DESIGN GUIDE

## TECHNICAL DATA

### TECHLINE HCVXR DRIPLINE



#### APPLICATIONS:

- Subsurface or on-surface installations
- Slopes
- Curved, angular or narrow areas
- High traffic/high liability areas
- Areas subject to vandalism
- Turf, shrubs, trees, flowers
- At-grade windows
- Sports turf, tennis courts, golf courses
- Green walls, green roofs
- Raised planters

#### SPECIFICATIONS:

- Emitter flows: 0.33, 0.53, 0.77, 1.16 GPH
- Emitter spacings: 12", 18", 24" (24" spacing available on 1,000 coils only)
- Pressure compensation range: 21.8 to 58 psi
- High Check Valve: holds back 8.5' of water
- Bending radius: 7"
- Maximum recommended system pressure: 58 psi
- Minimum pressure required: 21.8 psi
- Tubing diameter: 0.66" OD; 0.56" ID, 0.050" wall
- Coil lengths: 100', 250', 500', 1,000'
- Recommended minimum filtration: 120 mesh
- Diaphragm: molded silicon
- ISO 9261 Standard Compliance



#### FEATURES/BENEFITS:

##### LONG LASTING PROTECTION THROUGHOUT THE LIFE OF THE DRIPLINE

Cupron® copper oxide will not wash off, wear off and does not leach out of the emitter providing superior root intrusion resistance.

##### HIGH CHECK VALVE IN EACH EMITTER

The high check valve is great on slopes because it holds back 8.5' of water (elevation change) keeping the dripline charged for even distribution of water with no low emitter drainage.

##### NEW COLOR FOR EASY IDENTIFICATION

The dripline has a new color for easy identification as Techline HCVXR.

##### FOUR NEW EMITTER FLOW RATES

Achieve maximum design flexibility with four new emitter flow rates - the most options offered in the industry.

Techline HCVXR dripline also has the same superior features and benefits as Techline CV which include:

- **Physical Root Barrier** - the offset flow path, extra large bath area and raised outlet provide additional root intrusion protection
- **Anti-Siphon Feature** - prevents debris from entering the emitter outlet at system shut-down. Surface and subsurface installations don't require air relief valves
- **Pressure Compensating** - delivers precise, equal amounts of water over a broad pressure range
- **Continuous Self-flushing Emitter** - flushes debris as it's detected
- **Laser Etching** - permanent identification for model and flow rate right on the dripline
- **One-Piece Dripline Construction** - reliable, easy installation
- **Flexible UV Resistant Tubing** - bending radius of 7" adapts to any planting area shape

# NETAFIM TECHLINE® HCVXR and CV DESIGN GUIDE

## TECHNICAL DATA

### TECHLINE CV DRIPLINE



#### APPLICATIONS:

- Subsurface or on-surface installations
- Slopes
- Curved, angular or narrow areas
- High traffic/high liability areas
- Areas subject to vandalism
- High wind areas
- Turf, shrubs, trees, flowers
- At-grade windows
- Sports turf, tennis courts, golf courses
- Longer lateral runs
- Green walls, green roofs
- Raised planters

#### SPECIFICATIONS:

- Emitter flow rates (GPH): 0.26, 0.4, 0.6, 0.9
- Emitter spacings: 12", 18", 24" (24" is available in 0.6 & 0.9 GPH flow rates only)
- Pressure compensation range: 14.5 to 58 psi
- Maximum system pressure: 58 psi
- Tubing diameter: 0.560" I.D. x 0.660" O.D., 0.050" Wall
- Coil lengths: 100', 250', 500', 1,000'
- Recommended minimum filtration: 120 mesh
- Diaphragm made of silicon
- ISO 9261 Standard Compliance



#### FEATURES/BENEFITS:

- **2 psi check valve in each emitter:** All emitters turn on and off at the same time, maximizing balance of application. Holds back up to 4.6' of water (elevation change). No low emitter drainage, great on slopes. Delivers more precise watering.
- **Unique patented emitter design with physical root barrier:** Offset flow path, extra large bath area and raised outlet prevent root intrusion without chemical reliance.
- **Pressure compensating:** Precise and equal amounts of water are delivered over a broad pressure range.
- **Continuous self-flushing emitter design:** Flushes debris as it is detected, throughout operation, not just at the beginning or end of a cycle, ensuring uninterrupted emitter operation.
- **Emitter with anti-siphon feature:** Prevents ingestion of debris into tubing caused by vacuum.
- **Self-contained, one-piece dripline construction:** Assures reliable, easy installation.
- **Flexible UV resistant tubing:** Adapts to any planting area shape - tubing curves at a 7" radius. For on-surface installations withstands heat and direct sun.
- **Makes installation quicker:** Does not require air/vacuum relief vent or automatic flush valve for on-surface or subsurface installations. Use manual flush valves at exhaust headers.

# NETAFIM TECHLINE® HCVXR and CV DESIGN GUIDE

## TECHNICAL DATA

### TECHLINE CV EMITTER

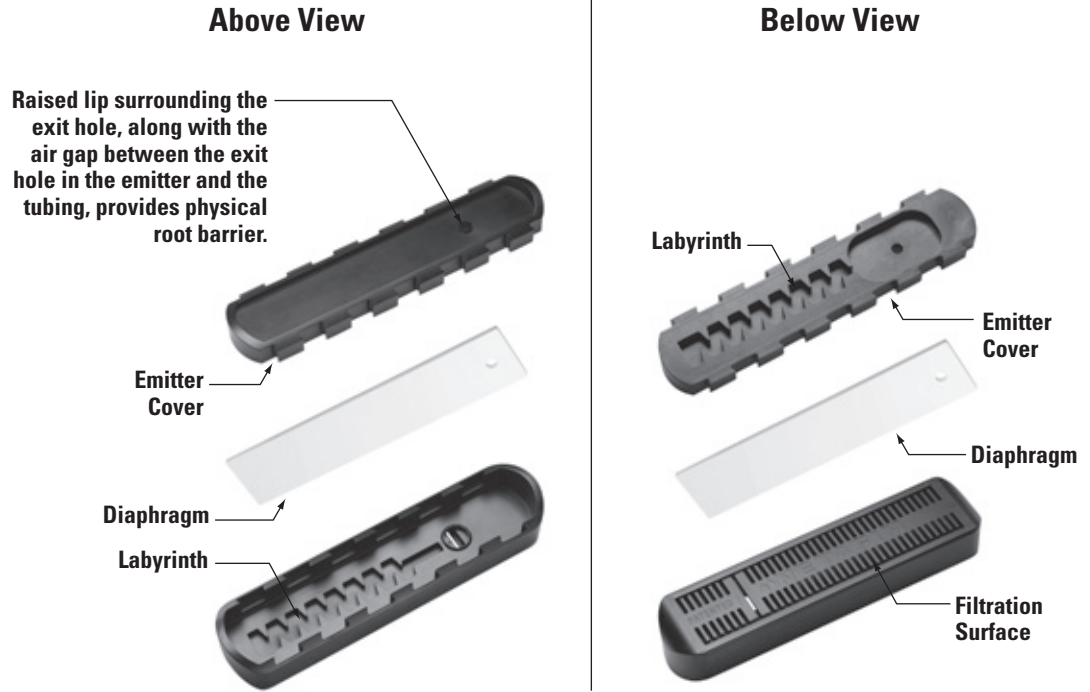

### TECHLINE HCVXR EMITTER

Cupron® copper oxide ( $\text{Cu}_2\text{O}$ ) technology effectively deters roots from growing in the HCVXR emitter. During the manufacturing process, the copper oxide is mixed with the emitter resin material infusing the copper oxide in the emitter. It will not wash off, wear off or leach out of the emitter. The copper colored top portion of the emitter contains the embedded copper oxide.



Top with embedded copper oxide



Diaphragm



Bottom with large filtration area

## DESIGN FORMULAS

### FORMULA 1.1

#### Estimated Total Length of Dripline =

$$\frac{\text{Irrigated Area} \times 12}{\text{Minimum Recommended Lateral Spacing (inches)}}$$

**In Which:**

Estimated Total Length of Dripline =  
Total Footage of Dripline in a Zone

Irrigated Area = Total Area in Square Feet

Minimum Recommended Lateral (Row) Spacing =

The minimum row spacing from the General Guidelines Chart in inches

### FORMULA 1.2

#### Application Rate =

$$\frac{231.1 \times \text{Emitter Flow Rate (GPH)}}{\text{Dripline Row Spacing (inches)} \times \text{Emitter Spacing (inches)}}$$

**In Which:**

Application Rate is = Inches per Hour of Water Being Applied

Emitter Flow Rate = Gallons per Hour Flow of One Emitter

Emitter Spacing = Spacing in Inches of Emitters Inside Tubing

Dripline Row Spacing = Inches Between Techline Laterals (rows)

**Note:** 0.4, 0.6, and 0.9 GPH are nominal flow rates. Actual flow rates of 0.42, 0.61, and 0.92 GPH should be used in the calculations.

### FORMULA 1.3

#### Number of Emitters in a Zone =

$$\frac{\text{Total Dripline} \times 12}{\text{Emitter Spacing (inches)}}$$

Number of Emitters = Number of Emitters

Total Dripline = Length of All Dripline in a Zone in Feet

Emitter Spacing = Spacing in Inches of Emitters Inside Tubing

### FORMULA 1.4

#### Flow Per Zone =

$$\frac{\text{Number of Emitters} \times \text{Emitter Flow Rate (GPH)}}{60}$$

**In Which:**

Flow Per Zone = Total Gallons per Minute

Number of Emitters = Number of Emitters

Emitter Flow Rate = Gallons per Hour of One Emitter

## DESIGN FORMULAS (CONTINUED)

### FORMULA 1.5

#### Estimated Total Zone Flow =

$$\left( \frac{\text{Irrigated Area} \times 144}{\text{Emitter Spacing (inches)} \times \text{Dripline Row Spacing (inches)}} \right) \times \text{Emitter Flow Rate (GPH)} \div 60$$

#### In Which:

Estimated Total Zone Flow = Gallons per Minute in Zone  
 Irrigated Area = Total Area in Square Feet  
 Emitter Spacing = Spacing in Inches of Emitters Inside Tubing  
 Dripline Row Spacing = Inches Between Techline Laterals (rows)  
 Emitter Flow Rate = Gallons per Hour of One Emitter

### FORMULA 1.6

#### Estimated Run Time =

$$\frac{\text{Daily Et (inches)}}{\text{Application Rate (inches per hour)}} \times 60 \text{ (minutes)}$$

#### In Which:

Estimated Run Time = Estimated Number of minutes of run time for a particular zone (based upon input data)

Et = Evapotranspiration; The amount of water released from soil by evaporation and transpiration from plants.

Daily Et = Monthly Et divided by the number of days in the associated month.

Application Rate = Inches per hour of water being applied. This can be calculated by using Formula 1.2, or by referencing the Application Rate Charts on pages 33 and 34.

60 minutes = Conversion factor from hours to minutes (60 minutes in one hour).

**Note:** Evapotranspiration rates for your geographic location can be found by searching the internet for local weather stations, from weather data services, from on-site weather collection devices, or from Historical Et data. If you are not irrigating daily, the Daily Et should be multiplied by the number of days since your prior irrigation cycle in order to replace the total Et since your previous irrigation cycle. If the Estimated Run Time is long enough to create water run-off, the total run time should be broken into multiple irrigation cycles. Cycle run time should not generate water run-off.



# NETAFIM TECHLINE® HCVXR and CV DESIGN GUIDE

## TECHNICAL DATA

### TECHLINE HCVXR SPECIFYING MODEL NUMBER

Reference for Ordering Information Chart

**A** Techline HCVXR = TLHCVXR Dripline

**SAMPLE MODEL NUMBER**  
**TLHCVXR3-1210**  
 (A) (B) (C) (D)

**B** **EMITTER FLOW RATE**  
 0.33 GPH = 3  
 0.53 GPH = 5  
 0.77 GPH = 7  
 1.16 GPH = 11

**C** **EMITTER SPACING**  
 12" = 12  
 18" = 18  
 24" = 24

**D** **COIL LENGTH**  
 100' = 01  
 250' = 025  
 500' = 05  
 1,000' = 10

**BLANK TUBING MODEL NUMBERS:**  
 100' = TLHCVXR001      250' = TLHCVXR0025  
 500' = TLHCVXR005      1,000' = TLHCVXR010

### TECHLINE CV SPECIFYING MODEL NUMBER

Reference for Ordering Information Chart

**A** Techline CV Dripline = TLCV

**SAMPLE MODEL NUMBER**  
**TLCV4-1210**  
 (A) (B) (C) (D)

**B** **EMITTER FLOW RATE**  
 0.26 GPH = 26  
 0.4 GPH = 4  
 0.6 GPH = 6  
 0.9 GPH = 9

**C** **EMITTER SPACING**  
 12" = 12  
 18" = 18  
 24" = 24

**D** **COIL LENGTH**  
 100' = 01  
 250' = 025  
 500' = 05  
 1,000' = 10

**BLANK TUBING MODEL NUMBERS:**  
 100' = TLCV001      250' = TLCV0025  
 500' = TLCV005      1,000' = TLCV010

### TECHLINE HCVXR AND CV TUBING DIMENSIONS

INSIDE DIAMETER	OUTSIDE DIAMETER	WALL THICKNESS
0.560"	0.660"	0.050"

### TECHLINE HCVXR AND CV MINIMUM BENDING RADIUS

7"
----

# NETAFIM TECHLINE® HCVXR and CV DESIGN GUIDE

## TECHNICAL DATA

### TECHLINE® HCVXR DRIPLINE APPLICATION RATE TABLES

**APPLICATION RATES 0.33 GPH EMITTER**

FLOW RATE (GPH)	EMITTER SPACING (IN.)	LATERAL SPACING (IN.)	APPLICATION RATE (IN./HR.)	TIME TO APPLY 1/4" (MIN.)
0.33	12	12	0.53	28
0.33	12	14	0.45	33
0.33	12	16	0.40	38
0.33	12	18	0.35	42
0.33	12	20	0.32	47
0.33	12	22	0.29	52
0.33	12	24	0.26	57
0.33	18	12	0.35	42
0.33	18	14	0.30	50
0.33	18	16	0.26	57
0.33	18	18	0.24	64
0.33	18	20	0.21	71
0.33	18	22	0.19	78
0.33	18	24	0.18	85
0.33	24	12	0.26	57
0.33	24	14	0.23	66
0.33	24	16	0.20	76
0.33	24	18	0.18	85
0.33	24	20	0.16	94
0.33	24	22	0.14	104
0.33	24	24	0.13	113

**APPLICATION RATES 0.53 GPH EMITTER**

FLOW RATE (GPH)	EMITTER SPACING (IN.)	LATERAL SPACING (IN.)	APPLICATION RATE (IN./HR.)	TIME TO APPLY 1/4" (MIN.)
0.53	12	12	0.85	18
0.53	12	14	0.73	21
0.53	12	16	0.64	24
0.53	12	18	0.56	27
0.53	12	20	0.51	30
0.53	12	22	0.46	32
0.53	12	24	0.42	35
0.53	18	12	0.56	27
0.53	18	14	0.48	31
0.53	18	16	0.42	35
0.53	18	18	0.38	40
0.53	18	20	0.34	44
0.53	18	22	0.31	49
0.53	18	24	0.28	53
0.53	24	12	0.42	35
0.53	24	14	0.36	41
0.53	24	16	0.32	47
0.53	24	18	0.28	53
0.53	24	20	0.25	59
0.53	24	22	0.24	65
0.53	24	24	0.21	71

**APPLICATION RATES 0.77 GPH EMITTER**

FLOW RATE (GPH)	EMITTER SPACING (IN.)	LATERAL SPACING (IN.)	APPLICATION RATE (IN./HR.)	TIME TO APPLY 1/4" (MIN.)
0.77	12	12	1.23	12
0.77	12	14	1.05	14
0.77	12	16	0.92	16
0.77	12	18	0.82	18
0.77	12	20	0.74	20
0.77	12	22	0.67	22
0.77	12	24	0.61	24
0.77	18	12	0.82	18
0.77	18	14	0.70	21
0.77	18	16	0.61	24
0.77	18	18	0.55	27
0.77	18	20	0.49	31
0.77	18	22	0.45	34
0.77	18	24	0.41	37
0.77	24	12	0.61	24
0.77	24	14	0.53	28
0.77	24	16	0.46	33
0.77	24	18	0.41	37
0.77	24	20	0.37	41
0.77	24	22	0.34	45
0.77	24	24	0.31	49

**APPLICATION RATES 1.16 GPH EMITTER**

FLOW RATE (GPH)	EMITTER SPACING (IN.)	LATERAL SPACING (IN.)	APPLICATION RATE (IN./HR.)	TIME TO APPLY 1/4" (MIN.)
1.16	12	12	1.86	8
1.16	12	14	1.60	9
1.16	12	16	1.40	11
1.16	12	18	1.24	12
1.16	12	20	1.12	13
1.16	12	22	1.02	15
1.16	12	24	0.93	16
1.16	18	12	1.24	12
1.16	18	14	1.07	14
1.16	18	16	0.93	16
1.16	18	18	0.83	18
1.16	18	20	0.75	20
1.16	18	22	0.68	22
1.16	18	24	0.62	24
1.16	24	12	0.93	16
1.16	24	14	0.80	19
1.16	24	16	0.70	21
1.16	24	18	0.62	24
1.16	24	20	0.56	27
1.16	24	22	0.51	30
1.16	24	24	0.47	32

Application Rate = (231.1 x GPH) / (Emitter Spacing x Lateral Spacing)

# NETAFIM TECHLINE® HCVXR and CV DESIGN GUIDE

## TECHNICAL DATA

### TECHLINE® CV DRIPLINE APPLICATION RATE TABLES

**APPLICATION RATES 0.26 GPH EMITTER**

FLOW RATE (GPH)	EMITTER SPACING (IN.)	LATERAL SPACING (IN.)	APPLICATION RATE (IN./HR.)	TIME TO APPLY 1/4" (MIN.)
0.26	12	12	0.42	36
0.26	12	14	0.36	42
0.26	12	16	0.31	48
0.26	12	18	0.28	54
0.26	12	20	0.25	60
0.26	12	22	0.23	66
0.26	12	24	0.21	72
0.26	18	12	0.28	54
0.26	18	14	0.24	63
0.26	18	16	0.21	72
0.26	18	18	0.19	81
0.26	18	20	0.17	90
0.26	18	22	0.15	99
0.26	18	24	0.14	108

**APPLICATION RATES 0.4 GPH EMITTER**

FLOW RATE (GPH)	EMITTER SPACING (IN.)	LATERAL SPACING (IN.)	APPLICATION RATE (IN./HR.)	TIME TO APPLY 1/4" (MIN.)
0.4	12	12	0.64	23
0.4	12	14	0.55	27
0.4	12	16	0.48	31
0.4	12	18	0.43	35
0.4	12	20	0.39	39
0.4	12	22	0.35	43
0.4	12	24	0.32	47
0.4	18	12	0.43	35
0.4	18	14	0.37	41
0.4	18	16	0.32	47
0.4	18	18	0.29	53
0.4	18	20	0.26	58
0.4	18	22	0.23	64
0.4	18	24	0.21	70

**APPLICATION RATES 0.6 GPH EMITTER**

FLOW RATE (GPH)	EMITTER SPACING (IN.)	LATERAL SPACING (IN.)	APPLICATION RATE (IN./HR.)	TIME TO APPLY 1/4" (MIN.)
0.6	12	12	0.96	16
0.6	12	14	0.83	18
0.6	12	16	0.72	21
0.6	12	18	0.64	23
0.6	12	20	0.58	26
0.6	12	22	0.53	29
0.6	12	24	0.48	31
0.6	18	12	0.64	23
0.6	18	14	0.55	27
0.6	18	16	0.48	31
0.6	18	18	0.43	35
0.6	18	20	0.39	39
0.6	18	22	0.35	43
0.6	18	24	0.32	47
0.6	24	12	0.48	31
0.6	24	14	0.41	36
0.6	24	16	0.36	42
0.6	24	18	0.32	47
0.6	24	20	0.29	52
0.6	24	22	0.26	57
0.6	24	24	0.24	62

**APPLICATION RATES 0.9 GPH EMITTER**

FLOW RATE (GPH)	EMITTER SPACING (IN.)	LATERAL SPACING (IN.)	APPLICATION RATE (IN./HR.)	TIME TO APPLY 1/4" (MIN.)
0.9	12	12	1.44	10
0.9	12	14	1.24	12
0.9	12	16	1.08	14
0.9	12	18	0.96	16
0.9	12	20	0.87	17
0.9	12	22	0.79	19
0.9	12	24	0.72	21
0.9	18	12	0.96	16
0.9	18	14	0.83	18
0.9	18	16	0.72	21
0.9	18	18	0.64	23
0.9	18	20	0.58	26
0.9	18	22	0.53	29
0.9	18	24	0.48	31
0.9	24	12	0.72	21
0.9	24	14	0.62	24
0.9	24	16	0.54	28
0.9	24	18	0.48	31
0.9	24	20	0.43	35
0.9	24	22	0.39	38
0.9	24	24	0.36	42

Application Rate = (231.1 x GPH) / (Emitter Spacing x Lateral Spacing)

# NETAFIM TECHLINE® HCVXR and CV DESIGN GUIDE

## TECHNICAL DATA

## TECHLINE END FEED LAYOUT

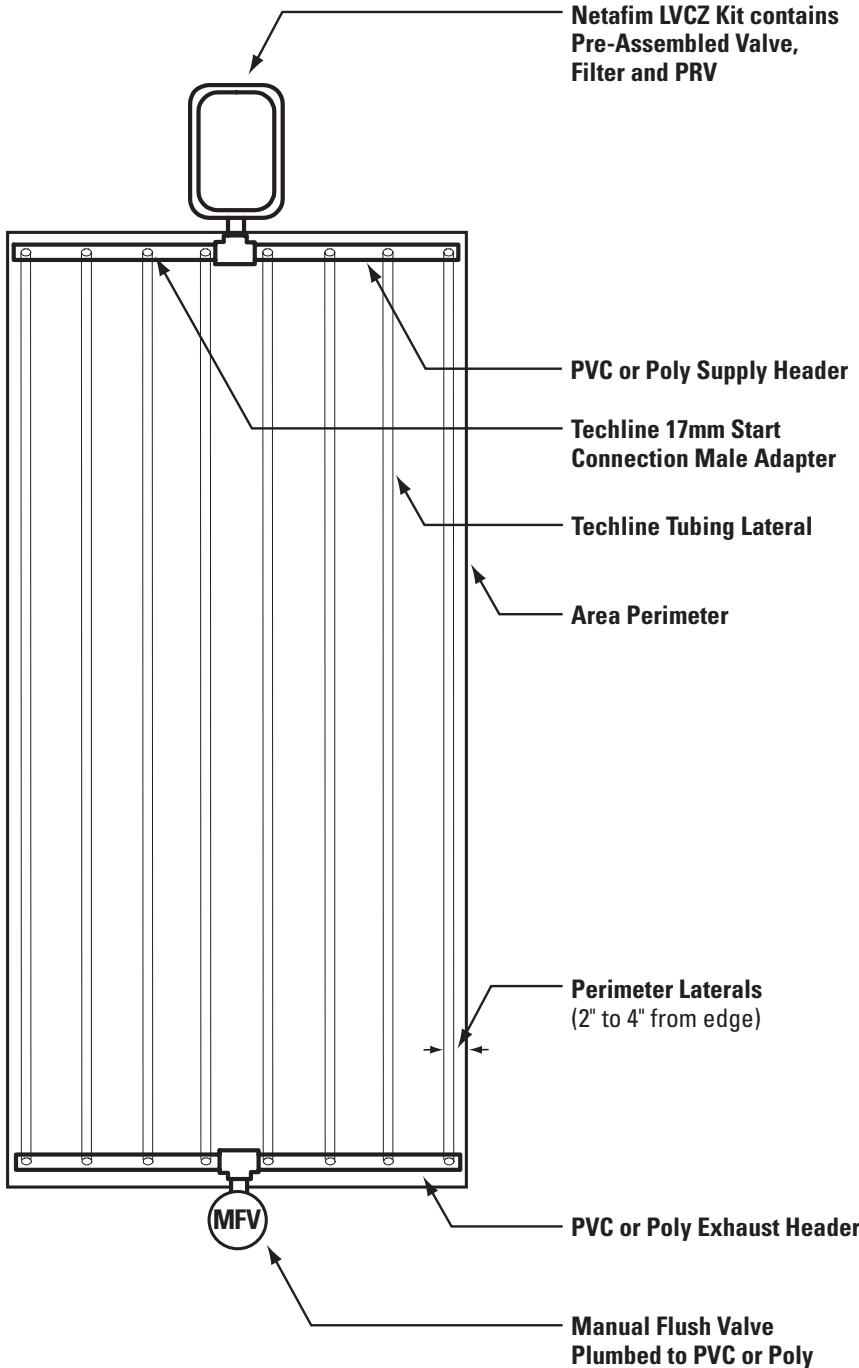



# NETAFIM TECHLINE® HCVXR and CV DESIGN GUIDE

## TECHNICAL DATA

## TECHLINE BLOCK SYSTEM ON SLOPE LAYOUT

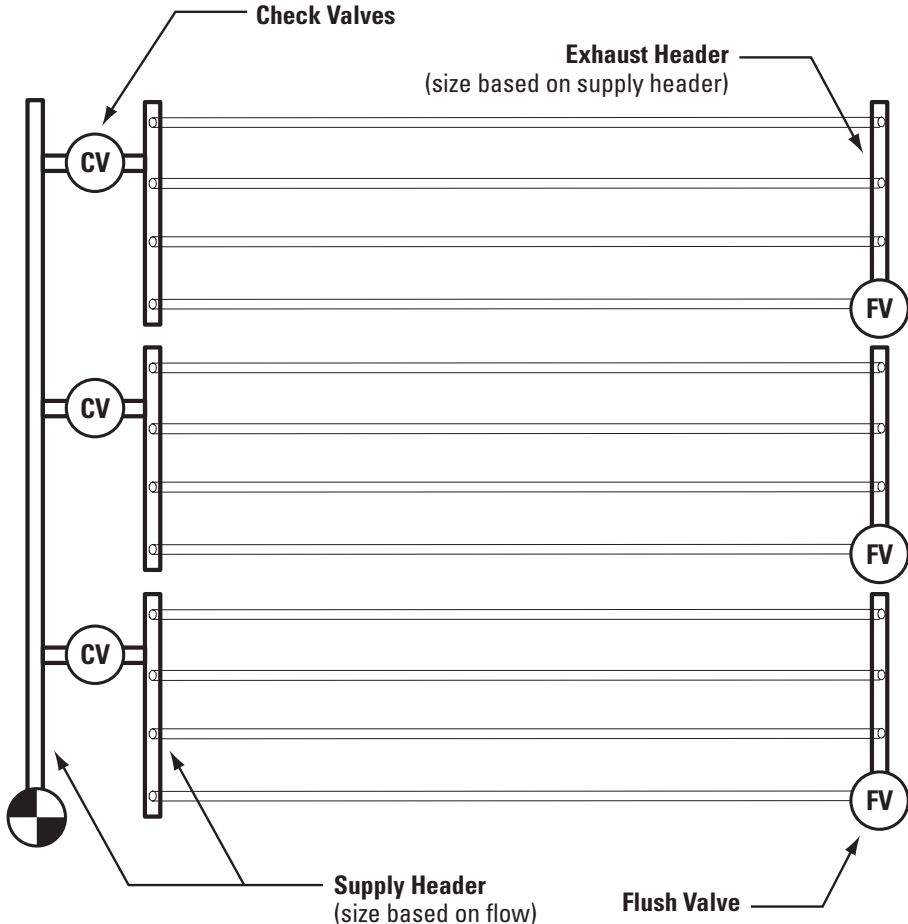

# NETAFIM TECHLINE® HCVXR and CV DESIGN GUIDE

## TECHNICAL DATA

## TECHLINE CENTER FEED LAYOUT

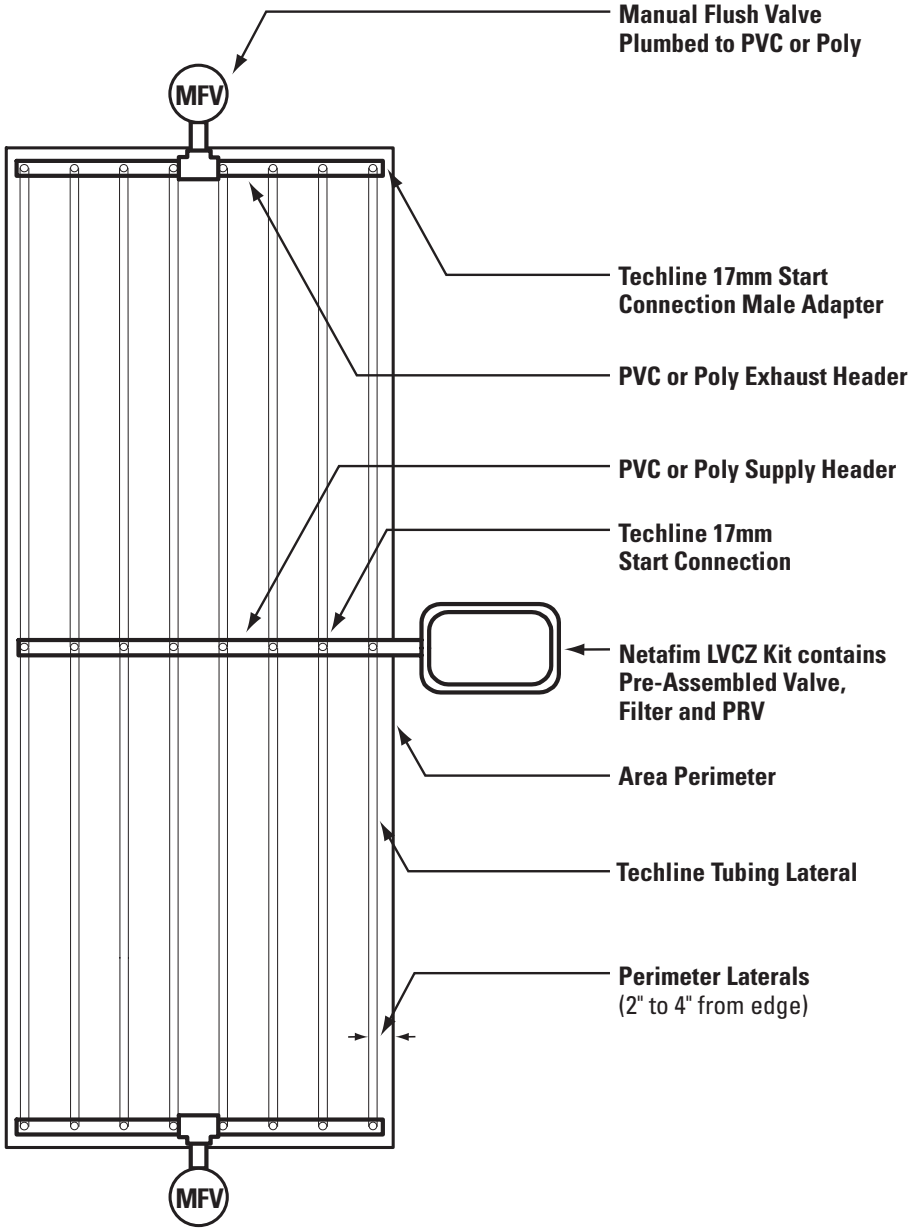

# NETAFIM TECHLINE® HCVXR and CV DESIGN GUIDE

---

## INSTALLATION CHECKLIST

**Project:** \_\_\_\_\_

**Date:** \_\_\_\_\_

1. Assemble and install Netafim LVCZ Kit with valve, filter and pressure regulator as indicated in Netafim detail(s) \_\_\_\_\_ .
2. Assemble and install supply header as indicated in Netafim detail(s) \_\_\_\_\_ . Tape or plug all open connections.
3. Assemble and install exhaust header as indicated in Netafim detail(s) \_\_\_\_\_ . Tape or plug all open connections.
4. Install Techline laterals beginning at the start connection(s) indicated in Netafim detail(s) \_\_\_\_\_ . Type and layout of laterals are to be installed as specified, and/or as indicated in Netafim detail(s) \_\_\_\_\_ . Tape or plug all open ends.
5. If required, install an air/vacuum relief valve at the point(s) of highest elevation in the zone as indicated in Netafim detail(s) \_\_\_\_\_ .
6. Make all Techline to fitting connections while flushing the system. Make connections as indicated in Netafim detail(s) \_\_\_\_\_ .
7. While flushing, connect Techline laterals to the exhaust header as indicated in Netafim detail(s) \_\_\_\_\_ .
8. Install line flushing valve(s) as indicated in Netafim detail(s) \_\_\_\_\_ .
9. Install other Netafim accessories as indicated in Netafim detail(s) \_\_\_\_\_ .
10. Operate and inspect the system. Record system data for historical record. Use Netafim System Inspection Checklist.





# NETAFIM TECHLINE® HCVXR and CV DESIGN GUIDE

**FRICION LOSS CHARACTERISTICS POLYETHYLENE (PE) SDR PRESSURE RATED PIPE (2306, 3206, 3306) SDR 7, 9, 11.5, 15, C=150, SIZES ½" TO 6", FLOWS 1 TO 900 GPM**

## PSI LOSS OF 100 FEET OF PIPE (psi per 100 feet)

Flow GPM	Flow GPH	½" I.D. 0.622"		¾" I.D. 0.824"		1" I.D. 1.049"		1 ¼" I.D. 1.380"		1 ½" I.D. 1.610"		2" I.D. 2.067"		2 ½" I.D. 2.469"		3" I.D. 3.068"		4" I.D. 4.026"		6" I.D. 6.065"		
		Velocity FPS	PSI Loss	Velocity FPS	PSI Loss	Velocity FPS	PSI Loss	Velocity FPS	PSI Loss	Velocity FPS	PSI Loss	Velocity FPS	PSI Loss	Velocity FPS	PSI Loss	Velocity FPS	PSI Loss	Velocity FPS	PSI Loss	Velocity FPS	PSI Loss	
1	60	1.06	0.49	0.60	0.12	0.37	0.04	0.21	0.01	0.16	0.00	0.10	0.00	0.07	0.00	0.04	0.00	0.03	0.00	0.01	0.00	
2	120	2.11	1.76	1.20	0.45	0.74	0.14	0.43	0.04	0.32	0.02	0.19	0.01	0.13	0.00	0.09	0.00	0.05	0.00	0.02	0.00	
3	180	3.17	3.73	1.80	0.95	1.11	0.29	0.64	0.08	0.47	0.04	0.29	0.01	0.20	0.00	0.13	0.00	0.08	0.00	0.03	0.00	
4	240	4.22	6.35	2.41	1.62	1.48	0.50	0.86	0.13	0.63	0.06	0.38	0.02	0.27	0.01	0.17	0.00	0.10	0.00	0.04	0.00	
5	300	5.28	9.60	3.01	2.44	1.86	0.76	1.07	0.20	0.79	0.09	0.48	0.03	0.34	0.01	0.22	0.00	0.13	0.00	0.06	0.00	
6	360	6.34	13.46	3.61	3.43	2.23	1.06	1.29	0.28	0.95	0.13	0.57	0.04	0.40	0.02	0.26	0.01	0.15	0.00	0.07	0.00	
7	420	7.39	17.91	4.21	4.56	2.60	1.41	1.50	0.37	1.10	0.18	0.67	0.05	0.47	0.02	0.30	0.01	0.18	0.00	0.08	0.00	
8	480	8.45	22.93	4.81	5.84	2.97	1.80	1.72	0.47	1.26	0.22	0.76	0.07	0.54	0.03	0.35	0.01	0.20	0.00	0.09	0.00	
9	540	9.50	28.52	5.41	7.26	3.34	2.24	1.93	0.59	1.42	0.28	0.86	0.08	0.60	0.03	0.39	0.01	0.23	0.00	0.10	0.00	
10	600	10.56	34.67	6.02	8.82	3.71	2.73	2.15	0.72	1.58	0.34	0.96	0.10	0.67	0.04	0.43	0.01	0.25	0.00	0.11	0.00	
11	660	11.61	41.36	6.62	10.53	4.08	3.25	2.36	0.86	1.73	0.40	1.05	0.12	0.74	0.05	0.48	0.02	0.28	0.00	0.12	0.00	
12	720	12.67	48.60	7.22	12.37	4.45	3.82	2.57	1.01	1.89	0.48	1.15	0.14	0.80	0.06	0.52	0.02	0.30	0.01	0.13	0.00	
14	840			8.42	16.45	5.20	5.08	3.00	1.34	2.21	0.63	1.34	0.19	0.94	0.08	0.61	0.03	0.35	0.01	0.16	0.00	
16	960			9.63	21.07	5.94	6.51	3.43	1.71	2.52	0.81	1.53	0.24	1.07	0.10	0.69	0.04	0.40	0.01	0.18	0.00	
18	1,080			10.83	26.21	6.68	8.10	3.86	2.13	2.84	1.01	1.72	0.30	1.21	0.13	0.78	0.04	0.45	0.01	0.20	0.00	
20	1,200			12.03	31.85	7.42	9.84	4.29	2.59	3.15	1.22	1.91	0.36	1.34	0.15	0.87	0.05	0.50	0.01	0.22	0.00	
22	1,320			13.24	38.00	8.17	11.74	4.72	3.09	3.47	1.46	2.10	0.43	1.47	0.18	0.95	0.06	0.55	0.02	0.24	0.00	
24	1,440					8.91	13.79	5.15	3.63	3.78	1.72	2.29	0.51	1.61	0.21	1.04	0.07	0.60	0.02	0.27	0.00	
26	1,560					9.65	16.00	5.58	4.21	4.10	1.99	2.49	0.59	1.74	0.25	1.13	0.09	0.66	0.02	0.29	0.00	
28	1,680					10.39	18.35	6.01	4.83	4.41	2.28	2.68	0.68	1.88	0.28	1.22	0.10	0.71	0.03	0.31	0.00	
30	1,800					11.14	20.85	6.44	5.49	4.73	2.59	2.87	0.77	2.01	0.32	1.30	0.11	0.76	0.03	0.33	0.00	
35	2,100					12.99	27.74	7.51	7.30	5.52	3.45	3.35	1.02	2.35	0.43	1.52	0.15	0.88	0.04	0.39	0.01	
40	2,400							8.58	9.35	6.30	4.42	3.82	1.31	2.68	0.55	1.74	0.19	1.01	0.05	0.44	0.01	
45	2,700							9.65	11.63	7.09	5.49	4.30	1.63	3.02	0.69	1.95	0.24	1.13	0.06	0.50	0.01	
50	3,000							10.73	14.14	7.88	6.68	4.78	1.98	3.35	0.83	2.17	0.29	1.26	0.08	0.56	0.01	
55	3,300							11.80	16.87	8.67	7.97	5.26	2.36	3.69	0.99	2.39	0.35	1.39	0.09	0.61	0.01	
60	3,600							12.87	19.82	9.46	9.36	5.74	2.77	4.02	1.17	2.60	0.41	1.51	0.11	0.67	0.01	
65	3,900							13.94	22.98	10.24	10.86	6.21	3.22	4.36	1.36	2.82	0.47	1.64	0.13	0.72	0.02	
70	4,200									11.03	12.45	6.69	3.69	4.69	1.55	3.04	0.54	1.76	0.14	0.78	0.02	
75	4,500									11.82	14.15	7.17	4.19	5.03	1.77	3.25	0.61	1.89	0.16	0.83	0.02	
80	4,800									12.61	15.95	7.65	4.73	5.36	1.99	3.47	0.69	2.02	0.18	0.89	0.03	
85	5,100									13.40	17.84	8.13	5.29	5.70	2.23	3.69	0.77	2.14	0.21	0.94	0.03	
90	5,400											8.61	5.88	6.03	2.48	3.91	0.86	2.27	0.23	1.00	0.03	
95	5,700											9.08	6.50	6.37	2.74	4.12	0.95	2.39	0.25	1.06	0.03	
100	6,000											9.56	7.15	6.70	3.01	4.34	1.05	2.52	0.28	1.11	0.04	
110	6,600											10.52	8.53	7.37	3.59	4.77	1.25	2.77	0.33	1.22	0.05	
120	7,200											11.47	10.02	8.04	4.22	5.21	1.47	3.02	0.39	1.33	0.05	
130	7,800											12.43	11.62	8.71	4.89	5.64	1.70	3.28	0.45	1.44	0.06	
140	8,400											13.39	13.33	9.38	5.61	6.08	1.95	3.53	0.52	1.55	0.07	
150	9,000													10.05	6.38	6.51	2.22	3.78	0.59	1.67	0.08	
160	9,600													10.72	7.19	6.94	2.50	4.03	0.67	1.78	0.09	
170	10,200													11.39	8.04	7.38	2.79	4.28	0.74	1.89	0.10	
180	10,800													12.06	8.94	7.81	3.11	4.54	0.83	2.00	0.11	
190	11,400													12.73	9.88	8.25	3.43	4.79	0.92	2.11	0.12	
200	12,000													13.40	10.87	8.68	3.78	5.04	1.01	2.22	0.14	
225	13,500														9.76	4.70	5.67	1.25	2.50	0.17		
250	15,000														10.85	5.71	6.30	1.52	2.78	0.21		
275	16,500														11.93	6.81	6.93	1.81	3.05	0.25		
300	18,000														13.02	8.00	7.56	2.13	3.33	0.29		
325	19,500																8.19	2.47	3.61	0.34		
350	21,000																8.82	2.84	3.89	0.39		
375	22,500																9.45	3.22	4.16	0.44		
400	24,000																10.08	3.63	4.44	0.49		
425	25,500																10.71	4.06	4.72	0.55		
450	27,000																11.34	4.52	5.00	0.62		
475	28,500																11.97	4.99	5.28	0.68		
500	30,000																12.60	5.49	5.55	0.75		
550	33,000																13.86	6.55	6.11	0.89		
600	36,000																		6.66	1.05		
650	39,000																		7.22	1.22		
700	42,000																		7.77	1.39		
750	45,000																		8.33	1.58		
800	48,000																		8.88	1.79		
850	51,000																		9.44	2.00		
900	54,000																		9.99	2.22		

**Note:** Shaded areas of the chart indicate velocities over 5 Ft/Sec. Use with Caution.

Velocities are calculated using the general equation:  
 $V = (0.4085 * (Q / d^2))$

Friction Losses are calculated using the Hazen-Williams Equation:  
 $H_f = 0.2083 * (100 / C)^{1.852} * (Q^{1.852} / d^{4.866})$

V = FPS (feet per second)

H<sub>f</sub> = PSI/100 Ft. (pounds per square inch per 100 feet)

C = 150

Q = GPM (gallons per minute)

d = ID (inside diameter)

# NETAFIM TECHLINE® HCVXR and CV DESIGN GUIDE

**FRICTION LOSS CHARACTERISTICS**  
**PVC SCHEDULE 40 IPS PLASTIC PIPE**  
 (1120, 1220)  
 C=150  
 Sizes 1/2" to 6"  
 Flows 1 to 900 GPM

## PSI LOSS OF 100 FEET OF PIPE (psi per 100 feet)

SIZE		1/2"	3/4"	1"	1 1/4"	1 1/2"	2"	2 1/2"	3"	4"	6"		
I.D.		0.622"	0.824"	1.049"	1.380"	1.610"	2.067"	2.469"	3.068"	4.026"	6.065"		
O.D.		0.840"	1.050"	1.315"	1.660"	1.900"	2.375"	2.875"	3.500"	4.500"	6.625"		
Wall Thk		0.109"	0.113"	0.133"	0.140"	0.145"	0.154"	0.203"	0.216"	0.237"	0.280"		
Flow GPM	Flow GPH	Velocity FPS	PSI Loss	Velocity FPS	PSI Loss	Velocity FPS	PSI Loss	Velocity FPS	PSI Loss	Velocity FPS	PSI Loss	Velocity FPS	PSI Loss
1	60	1.06	0.43	0.60	0.11	0.37	0.03	0.21	0.01	0.16	0.00	0.10	0.00
2	120	2.11	1.55	1.20	0.39	0.74	0.12	0.43	0.03	0.32	0.02	0.19	0.00
3	180	3.17	3.28	1.80	0.84	1.11	0.26	0.64	0.07	0.47	0.03	0.29	0.01
4	240	4.22	5.59	2.41	1.42	1.48	0.44	0.86	0.12	0.63	0.05	0.38	0.02
5	300	5.28	8.45	3.01	2.15	1.86	0.66	1.07	0.17	0.79	0.08	0.48	0.02
6	360	6.34	11.85	3.61	3.02	2.23	0.93	1.29	0.25	0.95	0.12	0.57	0.03
7	420	7.39	15.76	4.21	4.01	2.60	1.24	1.50	0.33	1.10	0.15	0.67	0.05
8	480	8.45	20.18	4.81	5.14	2.97	1.59	1.72	0.42	1.26	0.20	0.76	0.06
9	540	9.50	25.10	5.41	6.39	3.34	1.97	1.93	0.52	1.42	0.25	0.86	0.07
10	600	10.56	30.51	6.02	7.77	3.71	2.40	2.15	0.63	1.58	0.30	0.96	0.09
11	660	11.61	36.40	6.62	9.26	4.08	2.86	2.36	0.75	1.73	0.36	1.05	0.11
12	720	12.67	42.77	7.22	10.88	4.45	3.36	2.57	0.89	1.89	0.42	1.15	0.12
14	840			8.42	14.48	5.20	4.47	3.00	1.18	2.21	0.56	1.34	0.16
16	960			9.63	18.54	5.94	5.73	3.43	1.51	2.52	0.71	1.53	0.21
18	1,080			10.83	23.06	6.68	7.12	3.86	1.88	2.84	0.89	1.72	0.26
20	1,200			12.03	28.03	7.42	8.66	4.29	2.28	3.15	1.08	1.91	0.32
22	1,320			13.24	33.44	8.17	10.33	4.72	2.72	3.47	1.28	2.10	0.38
24	1,440					8.91	12.14	5.15	3.20	3.78	1.51	2.29	0.45
26	1,560					9.65	14.08	5.58	3.71	4.10	1.75	2.49	0.52
28	1,680					10.39	16.15	6.01	4.25	4.41	2.01	2.68	0.60
30	1,800					11.14	18.35	6.44	4.83	4.73	2.28	2.87	0.68
35	2,100					12.99	24.41	7.51	6.43	5.52	3.04	3.35	0.90
40	2,400							8.58	8.23	6.30	3.89	3.82	1.15
45	2,700							9.65	10.24	7.09	4.83	4.30	1.43
50	3,000							10.73	12.44	7.88	5.88	4.78	1.74
55	3,300							11.80	14.84	8.67	7.01	5.26	2.08
60	3,600							12.87	17.44	9.46	8.24	5.74	2.44
65	3,900							13.94	20.23	10.24	9.55	6.21	2.83
70	4,200									11.03	10.96	6.69	3.25
75	4,500									11.82	12.45	7.17	3.69
80	4,800									12.61	14.03	7.65	4.16
85	5,100									13.40	15.70	8.13	4.65
90	5,400											8.61	5.17
95	5,700											9.08	5.72
100	6,000											9.56	6.29
110	6,600									10.52	7.50	7.37	3.16
120	7,200									11.47	8.82	8.04	3.71
130	7,800									12.43	10.22	8.71	4.31
140	8,400									13.39	11.73	9.38	4.94
150	9,000											10.05	5.61
160	9,600									10.72	6.33	6.94	2.20
170	10,200									11.39	7.08	7.38	2.46
180	10,800									12.06	7.87	7.81	2.73
190	11,400									12.73	8.70	8.25	3.02
200	12,000									13.40	9.56	8.68	3.32
225	13,500											9.76	4.13
250	15,000											10.85	5.02
275	16,500											11.93	5.99
300	18,000											13.02	7.04
325	19,500											8.19	2.18
350	21,000											8.82	2.50
375	22,500											9.45	2.84
400	24,000											10.08	3.20
425	25,500											10.71	3.58
450	27,000											11.34	3.98
475	28,500											11.97	4.40
500	30,000											12.60	4.83
550	33,000											13.86	5.77
600	36,000												6.66
650	39,000												7.22
700	42,000												7.77
750	45,000												8.33
800	48,000												8.88
850	51,000												9.44
900	54,000												9.99

**Note:** Shaded areas of the chart indicate velocities over 5 Ft/Sec. Use with Caution.

Velocities are calculated using the general equation:  
 $V = (0.4085 * (Q / d^2))$

Friction Losses are calculated using the Hazen-Williams Equation:  
 $H_f = 0.2083 * (100 / C)^{1.852} * (Q^{1.852} / d^{4.866})$

V = FPS (feet per second)

H<sub>f</sub> = PSI/100 Ft. (pounds per square inch per 100 feet)

C = 150

Q = GPM (gallons per minute)

d = ID (inside diameter)

# NETAFIM TECHLINE® HCVXR and CV DESIGN GUIDE

**FRICITION LOSS CHARACTERISTICS PVC CLASS 200 IPS PLASTIC PIPE (1120, 1220) SDR 21, C=150, SIZES ½" TO 6", FLOWS 1 TO 900 GPM**

## PSI LOSS OF 100 FEET OF PIPE (psi per 100 feet)

SIZE		½" (Class 315)		¾"		1"		1 ¼"		1 ½"		2"		2 ½"		3"		4"		6"	
I.D.		0.716"		0.930"		1.189"		1.502"		1.720"		2.149"		2.601"		3.166"		4.072"		5.993"	
O.D.		0.840"		1.050"		1.315"		1.660"		1.900"		2.375"		2.875"		3.500"		4.500"		6.625"	
WALL		0.062"		0.060"		0.063"		0.079"		0.090"		0.113"		0.137"		0.167"		0.214"		0.316"	
Flow GPM	Flow GPH	Velocity FPS	PSI Loss	Velocity FPS	PSI Loss	Velocity FPS	PSI Loss	Velocity FPS	PSI Loss	Velocity FPS	PSI Loss	Velocity FPS	PSI Loss	Velocity FPS	PSI Loss	Velocity FPS	PSI Loss	Velocity FPS	PSI Loss	Velocity FPS	PSI Loss
1	60	0.80	0.22	0.47	0.06	0.29	0.02	0.18	0.01	0.14	0.00	0.09	0.00	0.06	0.00	0.04	0.00	0.02	0.00	0.01	0.00
2	120	1.59	0.78	0.94	0.22	0.58	0.07	0.36	0.02	0.28	0.01	0.18	0.00	0.12	0.00	0.08	0.00	0.05	0.00	0.02	0.00
3	180	2.39	1.65	1.42	0.46	0.87	0.14	0.54	0.04	0.41	0.02	0.27	0.01	0.18	0.00	0.12	0.00	0.07	0.00	0.03	0.00
4	240	3.19	2.82	1.89	0.79	1.16	0.24	0.72	0.08	0.55	0.04	0.35	0.01	0.24	0.01	0.16	0.00	0.10	0.00	0.05	0.00
5	300	3.98	4.26	2.36	1.19	1.44	0.36	0.91	0.12	0.69	0.06	0.44	0.02	0.30	0.01	0.20	0.00	0.12	0.00	0.06	0.00
6	360	4.78	5.97	2.83	1.67	1.73	0.51	1.09	0.16	0.83	0.08	0.53	0.03	0.36	0.01	0.24	0.00	0.15	0.00	0.07	0.00
7	420	5.58	7.95	3.31	2.23	2.02	0.67	1.27	0.22	0.97	0.11	0.62	0.04	0.42	0.01	0.29	0.01	0.17	0.00	0.08	0.00
8	480	6.37	10.18	3.78	2.85	2.31	0.86	1.45	0.28	1.10	0.14	0.71	0.05	0.48	0.02	0.33	0.01	0.20	0.00	0.09	0.00
9	540	7.17	12.66	4.25	3.55	2.60	1.07	1.63	0.34	1.24	0.18	0.80	0.06	0.54	0.02	0.37	0.01	0.22	0.00	0.10	0.00
10	600	7.97	15.38	4.72	4.31	2.89	1.30	1.81	0.42	1.38	0.22	0.88	0.07	0.60	0.03	0.41	0.01	0.25	0.00	0.11	0.00
11	660	8.77	18.35	5.20	5.14	3.18	1.56	1.99	0.50	1.52	0.26	0.97	0.09	0.66	0.03	0.45	0.01	0.27	0.00	0.13	0.00
12	720	9.56	21.56	5.67	6.04	3.47	1.83	2.17	0.59	1.66	0.30	1.06	0.10	0.72	0.04	0.49	0.02	0.30	0.00	0.14	0.00
14	840	11.16	28.69	6.61	8.04	4.05	2.43	2.54	0.78	1.93	0.40	1.24	0.14	0.85	0.05	0.57	0.02	0.34	0.01	0.16	0.00
16	960	12.75	36.73	7.56	10.29	4.62	3.11	2.90	1.00	2.21	0.52	1.42	0.17	0.97	0.07	0.65	0.03	0.39	0.01	0.18	0.00
18	1,080			8.50	12.80	5.20	3.87	3.26	1.24	2.49	0.64	1.59	0.22	1.09	0.09	0.73	0.03	0.44	0.01	0.20	0.00
20	1,200			9.45	15.56	5.78	4.71	3.62	1.51	2.76	0.78	1.77	0.26	1.21	0.10	0.82	0.04	0.49	0.01	0.23	0.00
22	1,320			10.39	18.56	6.36	5.62	3.98	1.80	3.04	0.93	1.95	0.32	1.33	0.12	0.90	0.05	0.54	0.01	0.25	0.00
24	1,440			11.34	21.81	6.93	6.60	4.35	2.12	3.31	1.09	2.12	0.37	1.45	0.15	0.98	0.06	0.59	0.02	0.27	0.00
26	1,560			12.28	25.29	7.51	7.65	4.71	2.45	3.59	1.27	2.30	0.43	1.57	0.17	1.06	0.07	0.64	0.02	0.30	0.00
28	1,680			13.22	29.01	8.09	8.78	5.07	2.82	3.87	1.46	2.48	0.49	1.69	0.19	1.14	0.07	0.69	0.02	0.32	0.00
30	1,800					8.67	9.97	5.43	3.20	4.14	1.65	2.65	0.56	1.81	0.22	1.22	0.08	0.74	0.02	0.34	0.00
35	2,100					10.11	13.27	6.34	4.26	4.83	2.20	3.10	0.74	2.11	0.29	1.43	0.11	0.86	0.03	0.40	0.01
40	2,400					11.56	16.99	7.24	5.45	5.52	2.82	3.54	0.95	2.42	0.38	1.63	0.14	0.99	0.04	0.45	0.01
45	2,700					13.00	21.13	8.15	6.78	6.21	3.51	3.98	1.19	2.72	0.47	1.83	0.18	1.11	0.05	0.51	0.01
50	3,000							9.05	8.24	6.90	4.26	4.42	1.44	3.02	0.57	2.04	0.22	1.23	0.06	0.57	0.01
55	3,300							9.96	9.83	7.59	5.08	4.86	1.72	3.32	0.68	2.24	0.26	1.35	0.08	0.63	0.01
60	3,600							10.86	11.55	8.28	5.97	5.31	2.02	3.62	0.80	2.45	0.31	1.48	0.09	0.68	0.01
65	3,900							11.77	13.39	8.98	6.93	5.75	2.34	3.92	0.93	2.65	0.36	1.60	0.10	0.74	0.02
70	4,200							12.68	15.36	9.67	7.95	6.19	2.69	4.23	1.06	2.85	0.41	1.72	0.12	0.80	0.02
75	4,500							13.58	17.46	10.36	9.03	6.63	3.05	4.53	1.21	3.06	0.46	1.85	0.14	0.85	0.02
80	4,800									11.05	10.17	7.08	3.44	4.83	1.36	3.26	0.52	1.97	0.15	0.91	0.02
85	5,100									11.74	11.38	7.52	3.85	5.13	1.52	3.46	0.58	2.09	0.17	0.97	0.03
90	5,400									12.43	12.65	7.96	4.28	5.43	1.69	3.67	0.65	2.22	0.19	1.02	0.03
95	5,700									13.12	13.99	8.40	4.73	5.74	1.87	3.87	0.72	2.34	0.21	1.08	0.03
100	6,000									13.81	15.38	8.85	5.20	6.04	2.06	4.08	0.79	2.46	0.23	1.14	0.04
110	6,600											9.73	6.21	6.64	2.45	4.48	0.94	2.71	0.28	1.25	0.04
120	7,200											10.61	7.30	7.25	2.88	4.89	1.11	2.96	0.33	1.36	0.05
130	7,800											11.50	8.46	7.85	3.34	5.30	1.28	3.20	0.38	1.48	0.06
140	8,400											12.38	9.71	8.45	3.83	5.71	1.47	3.45	0.43	1.59	0.07
150	9,000											13.27	11.03	9.06	4.36	6.11	1.67	3.70	0.49	1.71	0.08
160	9,600													9.66	4.91	6.52	1.89	3.94	0.55	1.82	0.08
170	10,200													10.27	5.49	6.93	2.11	4.19	0.62	1.93	0.09
180	10,800													10.87	6.11	7.34	2.35	4.43	0.69	2.05	0.11
190	11,400													11.47	6.75	7.74	2.59	4.68	0.76	2.16	0.12
200	12,000													12.08	7.42	8.15	2.85	4.93	0.84	2.27	0.13
225	13,500													13.59	9.23	9.17	3.55	5.54	1.04	2.56	0.16
250	15,000															10.19	4.31	6.16	1.27	2.84	0.19
275	16,500															11.21	5.14	6.77	1.51	3.13	0.23
300	18,000															12.23	6.04	7.39	1.78	3.41	0.27
325	19,500															13.25	7.01	8.01	2.06	3.70	0.31
350	21,000																	8.62	2.36	3.98	0.36
375	22,500																	9.24	2.68	4.27	0.41
400	24,000																	9.85	3.03	4.55	0.46
425	25,500																	10.47	3.38	4.83	0.52
450	27,000																	11.09	3.76	5.12	0.57
475	28,500																	11.70	4.16	5.40	0.63
500	30,000																	12.32	4.57	5.69	0.70
550	33,000																	13.55	5.46	6.26	0.83
600	36,000																			6.82	0.98
650	39,000																			7.39	1.13
700	42,000																			7.96	1.30
750	45,000																			8.53	1.48
800	48,000																			9.10	1.67
850	51,000																			9.67	1.86
900	54,000																			10.24	2.07

**Note:** Shaded areas of the chart indicate velocities over 5 Ft/Sec. Use with Caution.

Velocities are calculated using the general equation:

$$V = (0.4085 * (Q / d^2))$$

Friction Losses are calculated using the Hazen-Williams Equation:

$$H_f = 0.2083 * (100 / C)^{1.852} * (Q^{1.852} / d^{4.866})$$

V = FPS (feet per second)

Hf = PSI/100 Ft. (pounds per square inch per 100 feet)

C = 150

Q = GPM (gallons per minute)

d = ID (inside diameter)





**NETAFIM USA**  
5470 E. HOME AVE.  
FRESNO, CA 93727  
CS 888 638 2346  
[www.netafimusa.com](http://www.netafimusa.com)