

WATER METERS

OCTAVE®

ULTRASONIC WATER METER

INSTALLATION & USER GUIDE



TABLE OF CONTENTS

General Information.....	4
Warranty	4
Included Items	4
Operation	5
Specifications	5
Dimensions & Weight	5
Installation	
Handling the Water Meter.....	6
Installation Position & Location	6
Installation Examples	7
Installation Notes	8
Pipe Flanges.....	8
Start-Up	8
Hardware Versions	9
Outputs	
Open Collector Pulse Output Module.....	10
Solid State Relay Pulse Output Module	11
Dry Contact (Mechanical) Pulse Output Module	12
Analog Output Module	13
Grounding Instructions	14
Grounding Parts	15

GENERAL INFORMATION

- Do not install, operate or maintain this flow meter without reading, understanding and following the factory-supplied instructions. Otherwise, injury or damage may result.
- Read these instructions carefully before beginning installation and save them for future reference.
- Observe all warnings and instructions marked on the product and in this guide.
- Consider handling and lifting instructions to avoid damage.
- If the product does not operate normally, refer to instructions or call your Netafim Representative.
- There are no operator-serviceable parts inside this product.

WARRANTY

Octave water meters are warranted to be free from original defects in materials and workmanship for a period up to five (5) years. If the meter encounters a problem, Netafim USA will choose to cover the cost of repair or replacement based on a five (5) year pro-rated schedule as follows:

Year 0 through Year 2: 100%

Year 2 through Year 3: 75%

Year 3 through Year 4: 50%

Year 4 through Year 5: 25%

All Octave water meters must be installed with a Netafim branded Combination Air/Vacuum or Continuous Acting Air Vents to qualify for the five (5) year pro-rated product warranty.

INCLUDED ITEMS

- One Octave Ultrasonic Water Meter, size as indicated on the packaging box, pieced together into a complete compact system (flow tube plus electronics).
- One pre-installed Output Module (if ordered).
- Documentation includes: Installation and User Manual and Certificate of Calibration Data.
- This product has been thoroughly inspected, tested and calibrated before shipment and is ready for operation.
- After carefully unpacking the meter, inspect for shipping damage before attempting to install. If any indication of damage is found, immediately contact the responsible transportation company and Netafim USA.

OPERATION

- The Octave's measurement method is based on an ultrasonic, transit-time, dual-beam sensors that determines the length of time it takes an ultrasonic wave to travel the distance between the two sensors located in the meter's body. The sensors function as both sender and receiver, each one alternating these functions so that the ultrasonic wave travels both with and against the direction of the flow. Because the ultrasonic wave travels slower against the flow than with the flow, the time difference of the two waves allows the meter to determine the flow rate.
- The Octave is a battery-powered precision water meter designed for linear, bidirectional flow measurement of water.
- Flow measurement values can be transferred through an output module.
- The Octave display can be set up for a wide range of outputs.

SPECIFICATIONS

- Maximum Working Pressure: 230 psi
- Liquid Temperature: 32° to 122° F
- Precision Class: ISO 4064 rev.2005, Accuracy Class 2
- Configuration: Compact - display is built into the unit
- Power Source: 2 'D' size Lithium Batteries (not serviceable by user), up to 15 years
- Environmental Protection: IP-68, Ambient operation temperature for display: -13° to 131° F (-25° to 55° C)
- Display Units: Multi-line, programmable 9 digit LCD display
- Volume Display Options: 1. Net (Forward less Reverse), 2. Forward Only, 3. Forward and Reverse Alternating 4. Reverse Only*
- Outputs (optional): Programmable single/dual open collector pulse output our externally powered 4-20 mA loop
- Connections: Flanges ANSI ISO for AWWA connection standard
- Severity Levels: Environmental class C, mechanical class M1, Electromagnetic environment class E1
- Pressure Loss: ΔP 0.16 bar or 2.32 psi

DIMENSIONS & WEIGHT

DIMENSIONS & WEIGHT					
SIZE	LENGTH (L)	WIDTH (B)	HEIGHT (H)	HEIGHT (h)	WEIGHT
2"	7.9"	6.5"	7.5"	1.6"	19.8 LBS.
3"	8.9"	7.9"	8.3"	3.5"	28.7 LBS.
4"	9.8"	8.7"	8.8"	4.1"	33.1 LBS.
6"	11.8"	11.2"	11.1"	5.5"	70.5 LBS.
8"	13.8"	13.4"	13.1"	6.5"	99 LBS.
10"	17.7"	15.9"	15.9"	8.0"	150 LBS.
12"	19.7"	19.2"	19.3"	9.6"	216 LBS.

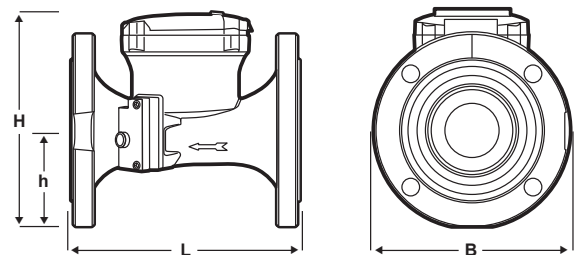

* Available in hardware version 4.01 and newer

INSTALLATION

HANDLING THE WATER METER

Important handling Information:

- Do not lift the Octave by the electronic housing.
- Do not carry the Octave by the lid.
- Do not place the Octave on the electronic housing.
- When handling the Octave, avoid hard blows, jolts or impacts.

INSTALLATION POSITION & LOCATION

Installation requirements for position and location are illustrated below.

PROPER INSTALLATION EXAMPLES

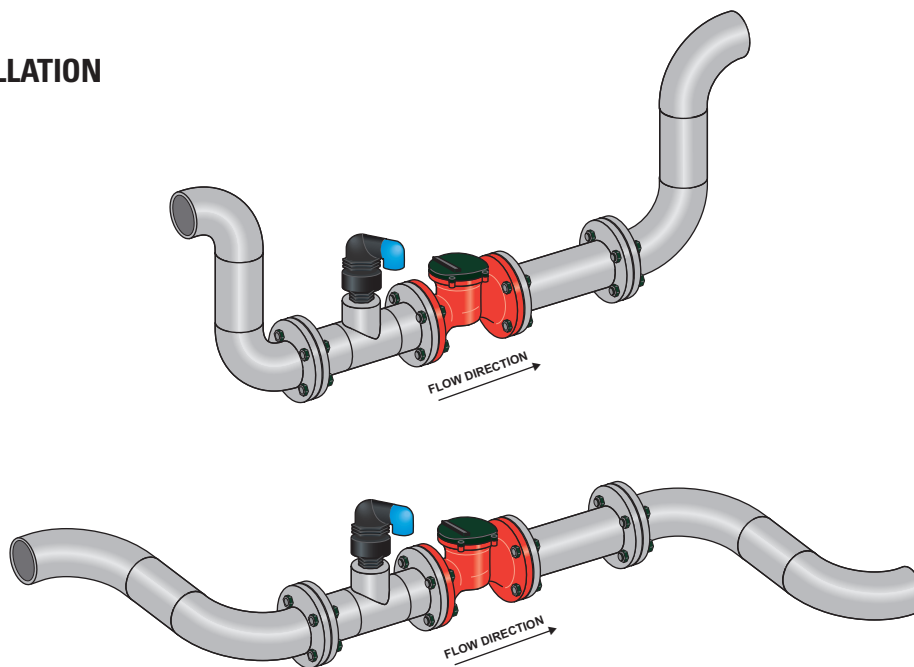

WRONG INSTALLATION EXAMPLES

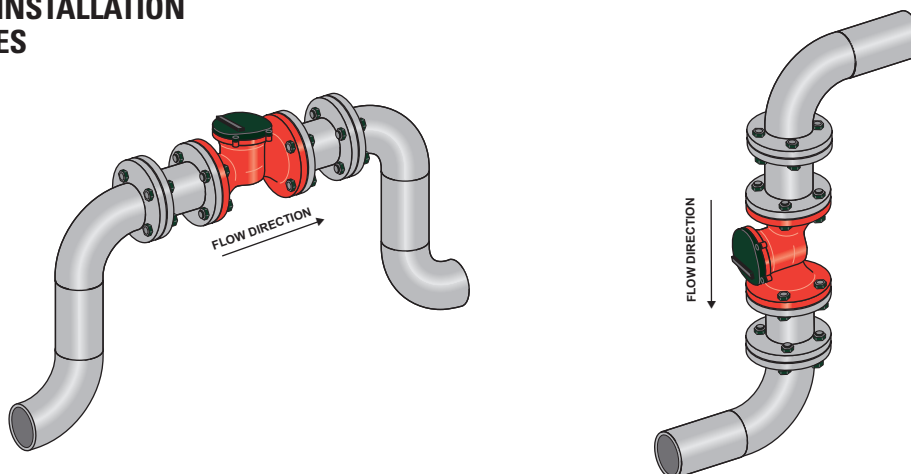

INSTALLATION EXAMPLES FOR ACHIEVING TOP PERFORMANCE

The following examples are recommendations for achieving top performance.

- Two (2) diameters of straight pipe are required when installing a 90° elbow before or after the meter. (See Figure 1)
- Two (2) diameters of straight pipe are required when installing the meter upstream or downstream of a valve, tee connection or other source of significant turbulence. (See Figures 2 and 3)
NOTE: The installation of the meter upstream of a pump or large valve is not recommended due to potential cavitation issues.
- Five (5) diameters of straight pipe downstream of a pump (before the meter) and Two (2) diameters of straight pipe downstream of the meter are required. (See Figure 4)
NOTE: When the meter is downstream of the pump, Netafim recommends additional straight pipe to ensure accurate measurements.
- Meter can be installed horizontally or vertically with the water flowing up. It is not recommended for installation where the direction of flow is below the horizontal plane. (See Figure 5)
- To eliminate air in the pipeline and maintain accuracy, use of and proper placement of Continuous Acting Air Vents is required. We require a Combination Air/Vacuum Release Air Vent or the Pro Air Vent.
- Recommended Air Vent placement: 3" and 4" meters place air vent 12" to 18" before the meter; 6" and 8" meters place the air vent 18" to 24" before the meter; 10" and 12" meters place the air vent 30" to 36" before the meter.
- Installing a Check Valve downstream of the meter creates back pressure to aid in the meter filling with water.

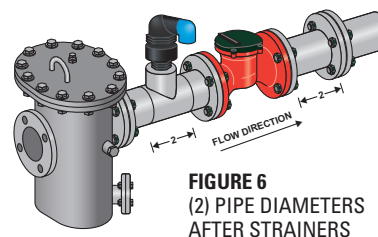
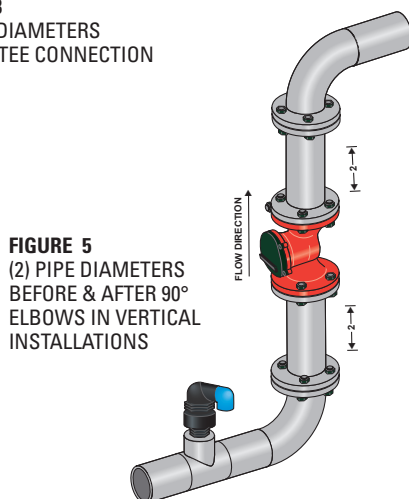
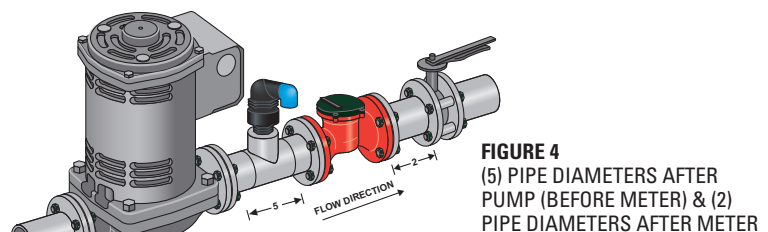
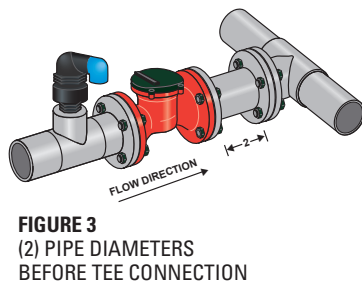
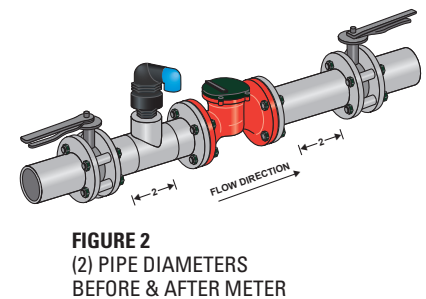
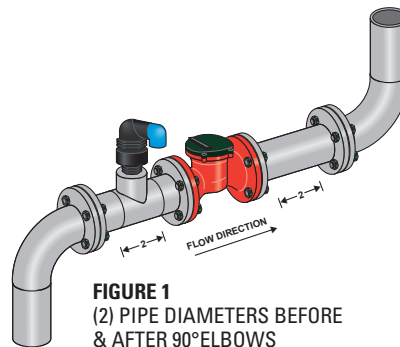
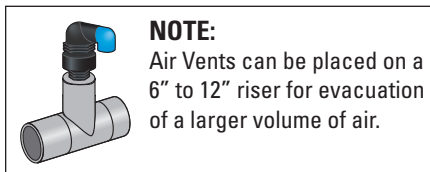

INSTALLATION

INSTALLATION NOTES

- For proper flow measurement, the Octave's measuring chamber should be completely full at all times. Non-wetted sensors show loss of signal. Though this will not cause damage to the meter, it will however, not measure flow and display zero.
- Flow direction: the Octave is a bidirectional water meter. Note the indicating arrow on the Octave display for forward and backward flow.
- Leave the lid closed except when reading the meter.
- Do not expose the Octave to excessive vibration. To avoid vibration, support the pipeline on both sides of the meter.
- To avoid measuring errors due to air in the flow tube, observe the following precautions:
 - Since air collects at the highest point in the system, installation of the water meter should be at the lowest point
 - Always install control valves downstream of the meter in order to avoid cavitation
 - Never install the meter on a pump suction side in order to avoid cavitation

PIPE FLANGES

- Refer to the standard dimensional drawings for flange spacing, accommodating for the thickness of gaskets.
- Install meter inline with the pipe axis. The pipe flange faces must be parallel to each other.
- Permissible length deviation: $L_{max} - L_{min} 0.5\text{mm} (0.02")$.

START-UP

- Check that the meter has been installed correctly.
- Check that the flow rate and volume units are correctly pre-programmed on the display.
- Check that the output module is correctly attached.

HARDWARE VERSIONS

There are now two different hardware versions for the Octave Water Meter. Version 3 was for Octave Water Meters manufactured prior to June 2017 and Version 4 for all Octave Water Meters currently available. Version 4 adds additional measuring units, water temperature, pulse output resolution and a sleep mode to the LCD.

VERSION 3

Legend for Version 3 LCD icons:

- GAL** VOLUME UNITS
- GPM** FLOW RATE UNITS
- BATTERY LEVEL** (Battery icon)
- ↑ ↓** FLOW DIRECTION
- ⚠** ALARM/ERROR
- ⚡** OUTPUT MODE

VERSION 4

Legend for Version 4 LCD icons:

- ↑ ↓** FLOW DIRECTION
- ⚠** SYSTEM ERROR
- m³/h L/s/L/m IGPM** FLOW RATE UNITS
- 188 °C °F** WATER TEMPERATURE
- Pulse #1 80000 Pulse #2 80000** PULSE RESOLUTION
- FWD| NET| BCK|** ACCUMULATOR MODE
- bl m³ IGAE ft³** VOLUME UNITS
- LOW BATT.** LOW BATTERY ALERT
- 4-20mA AMI TYPE: 8** COMM MODE
- 4-20mA AMI TYPE: 8** OUTPUT MODE

By default, SLEEP mode is activated after the meter has been empty for 24 hours and it will resume once the metering chamber is filled.

OUTPUTS

OPEN COLLECTOR PULSE OUTPUT MODULE

- Netafim Item # 70220-060400
- Not intended to support multiple reading devices

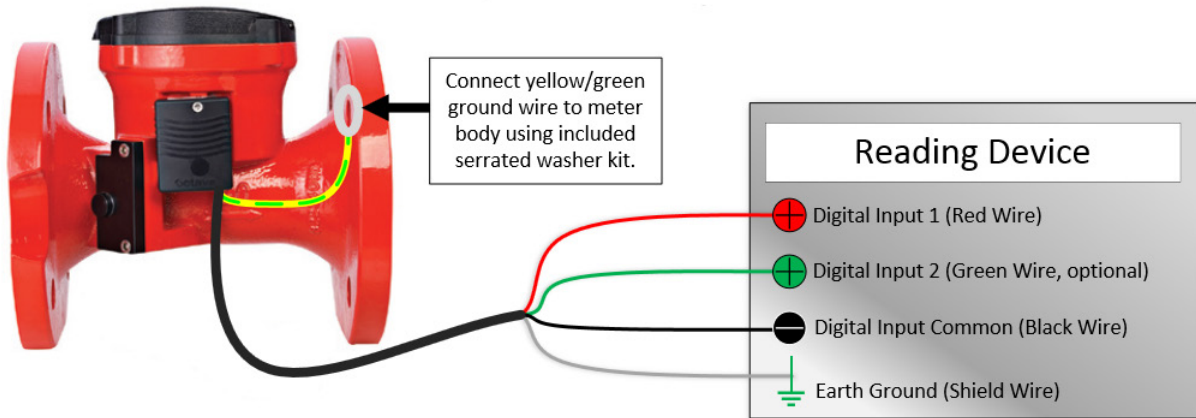

OUTPUT CABLES

CABLE	WIRE	FUNCTION
LONG CABLE	RED	PULSE OUT #1
	GREEN	PULSE OUT #2
	BLACK	PULSE COMMON
	SHIELD	GROUND
SHORT CABLE	RING TERMINAL	GROUND TO METER

WARNING: Signal connection polarity is mandatory.

OUTPUT CHARACTERISTICS

OUTPUT TYPE	OPEN COLLECTOR
CABLE LENGTH SUPPLIED	5 FEET
MAXIMUM CABLE LENGTH*	1,640 FEET
MAXIMUM APPLIED VOLTAGE	35 VDC
MAXIMUM APPLIED CURRENT	200mA

*The Maximum cable length depends on the cable type, controller and electrical noise level

SOLID STATE RELAY PULSE OUTPUT MODULE

- Netafim Item # 70220-060410
- Can support multiple reading devices (isolated outputs)
- Requires external 5-35vDC power source

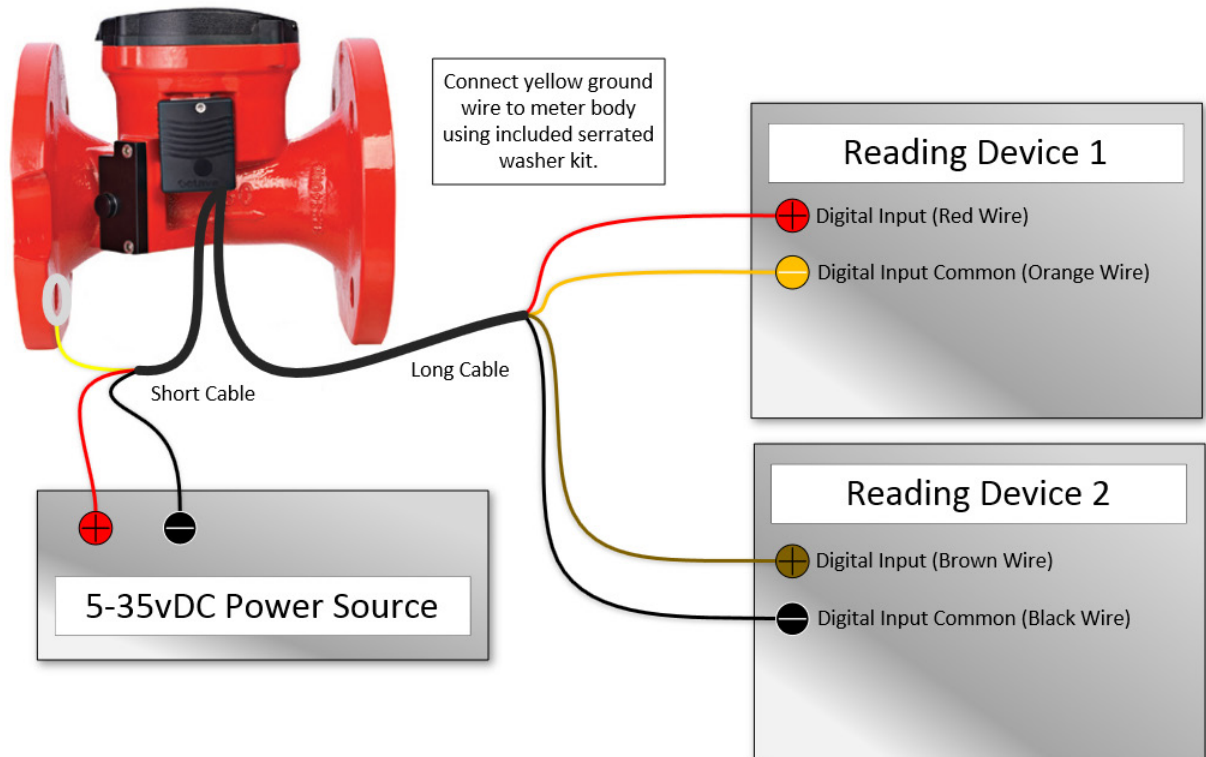

OUTPUT CABLES		
CABLE	WIRE	FUNCTION
LONG CABLE	RED & ORANGE	PULSE OUT #1
	BROWN & BLACK	PULSE OUT #2
SHORT CABLE	RED	5-35 vDC +
	BLACK	5-35 vDC -
	YELLOW	GROUND TO METER

OUTPUT CHARACTERISTICS	
OUTPUT TYPE	SOLID STATE RELAY
CABLE LENGTH SUPPLIED	5 FEET
MAXIMUM CABLE LENGTH*	1,640 FEET
MAXIMUM APPLIED VOLTAGE	+/- 400V
MAXIMUM APPLIED CURRENT	120mA
SUPPLY VOLTAGE	5-35 vDC

* The Maximum cable length depends on the cable type, controller and electrical noise level

OUTPUTS

DRY CONTACT (MECHANICAL) PULSE OUTPUT MODULE

- Netafim Item # 70220-002410
- Can support multiple reading devices (isolated outputs)
- Requires external 5-35vDC power source
- Mechanical relay life expectancy is 10⁹ cycles
- Recommend for low resolution applications (10 to 100 gallons/pulse)

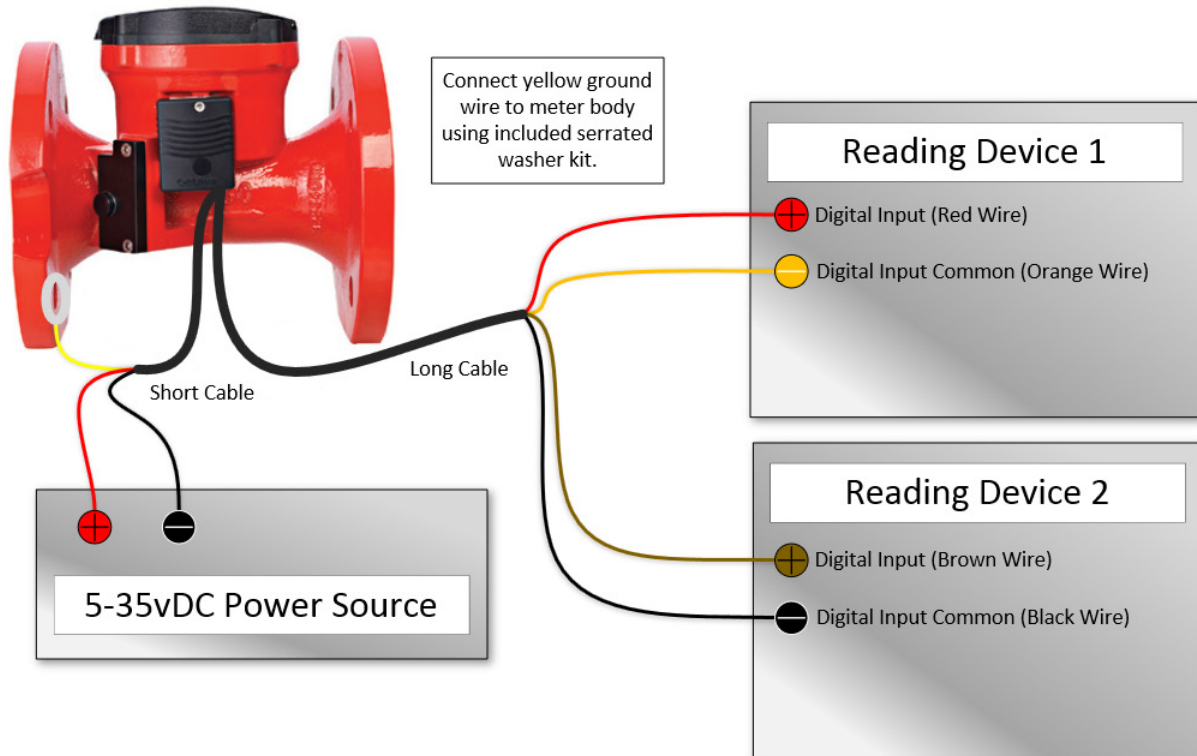

OUTPUT CABLES

CABLE	WIRE	FUNCTION
LONG CABLE	RED & ORANGE	PULSE OUT #1
	BROWN & BLACK	PULSE OUT #2
SHORT CABLE	RED	5-35 vDC +
	BLACK	5-35 vDC -
	YELLOW	GROUND TO METER

OUTPUT CHARACTERISTICS

OUTPUT TYPE	SOLID STATE RELAY
CABLE LENGTH SUPPLIED	5 FEET
MAXIMUM CABLE LENGTH*	1,640 FEET
MAXIMUM APPLIED POWER	15 WATT
SUPPLY VOLTAGE	5-35 vDC

* The Maximum cable length depends on the cable type, controller and electrical noise level

4-20mA ANALOG OUTPUT MODULE

- Netafim Item # 70220-011565
- The current output is a passive 4-20mA, 12-24VDC loop powered
- 4mA is always '0' zero flow and the 20mA is factory programmed to the SAFE MAX FLOW value printed on the sticker below the LCD

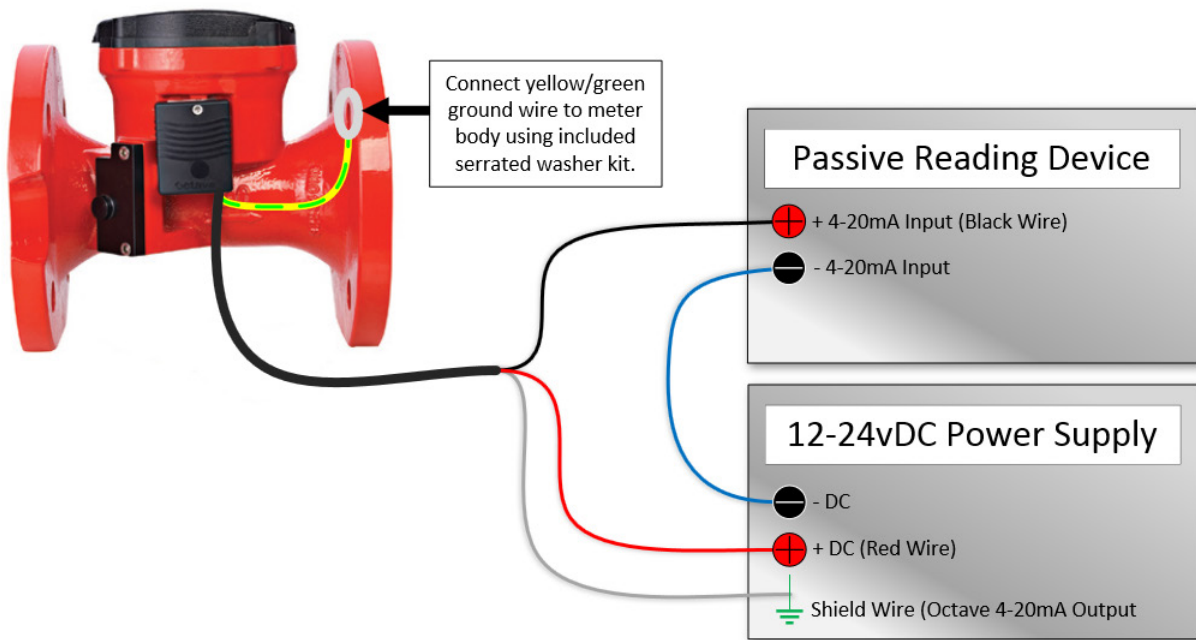
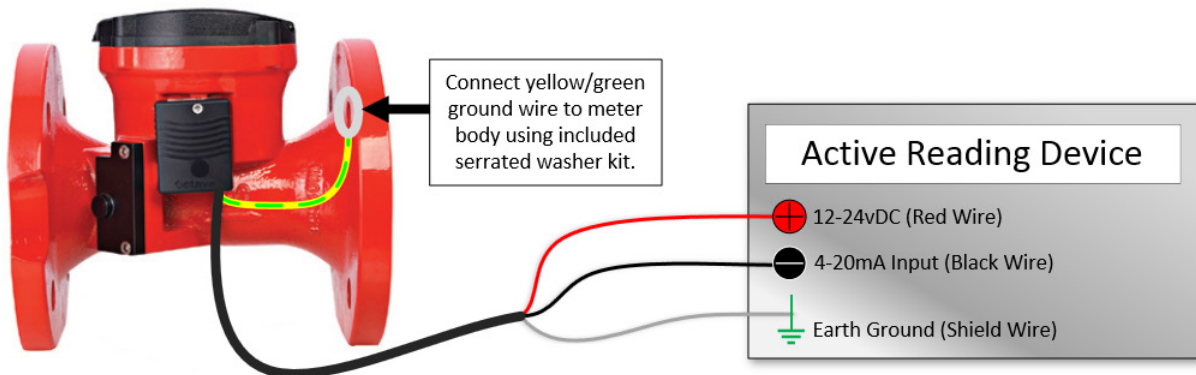

OUTPUT CABLES

CABLE	WIRE	FUNCTION
LONG CABLE	RED	CURRENT LOOP +
	BLACK	CURRENT LOOP -
	SHIELD	GROUND
SHORT CABLE	RING TERMINAL	GROUND TO METER

WARNING: Signal connection polarity is mandatory.

OUTPUT CHARACTERISTICS

OUTPUT TYPE	4-20mA OUTPUT
CABLE LENGTH SUPPLIED	5 FEET
MAXIMUM CABLE LENGTH*	1,640 FEET
LOOP SUPPLY VOLTAGE	12 - 24 VDC
OUTPUT IMPEDANCE	25 [M] TYP

* The Maximum cable length depends on the cable type, controller and electrical noise level

GROUNDING INSTRUCTIONS



STEP 1
Insert the M5 screw through the pre-assembled Ring Terminal Lug.

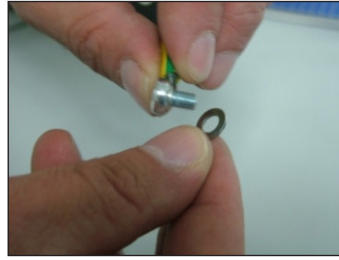

STEP 2
Insert the flat washer on top of the Ring Terminal Lug.



STEP 3
Insert the serrated washer on the flat washer.

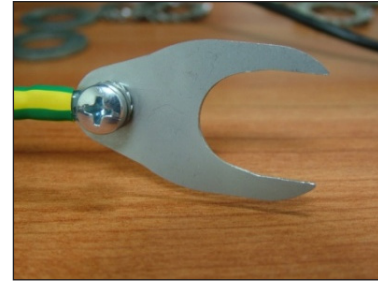
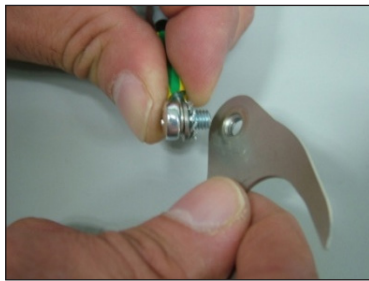

STEP 4
Attach to the Fork Terminal Lug and tighten (as shown in all three pictures).



STEP 5
Insert flat washer and serrated washer on bolt - use the correct washers per bolt size (M16 or M20 respectively). Insert the bolt in the hole of the pipe's flange - do not insert on meter's flange.

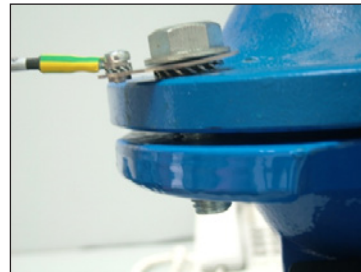

STEP 6
Slide the Fork Terminal Lug between the flat washer and serrated washer.



STEP 7
Add serrated washer to the other side of the bolt (on meter's flange side).



STEP 8
Add the flat washer on top of the serrated washer.

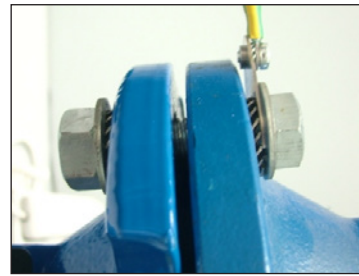

STEP 9
Add nut and tighten. Make sure the Fork Terminal Lug is in position.

GROUNDING PARTS

PARTS KIT FOR RING TERMINAL LUG

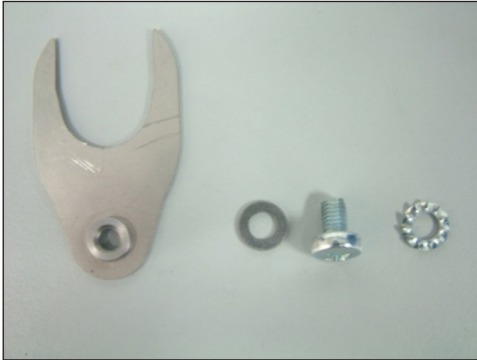

PICTURED LEFT TO RIGHT

- Fork Terminal Lug
- Flat Washer
- M5 Screw
- Serrated Washer

PARTS KIT FOR FORK TERMINAL LUG CONNECTION TO PIPE



PICTURED TOP TO BOTTOM

- M16 or M20 Bolt (not included in kit)
- Flat Washer in M16 and M20 size (2 each included in kit)
- Serrated Washer in M16 and M20 sizes (2 each included in kit)
- M16 or M20 Nut (not included in kit)



GROW MORE WITH LESS

NETAFIM USA
5470 E. Home Ave.
Fresno, CA 93727
CS 888 638 2346
www.netafimusa.com