

SANDSTORM™

METAL SINGLE/DOUBLE CHAMBER MEDIA FILTER

INSTALLATION MANUAL

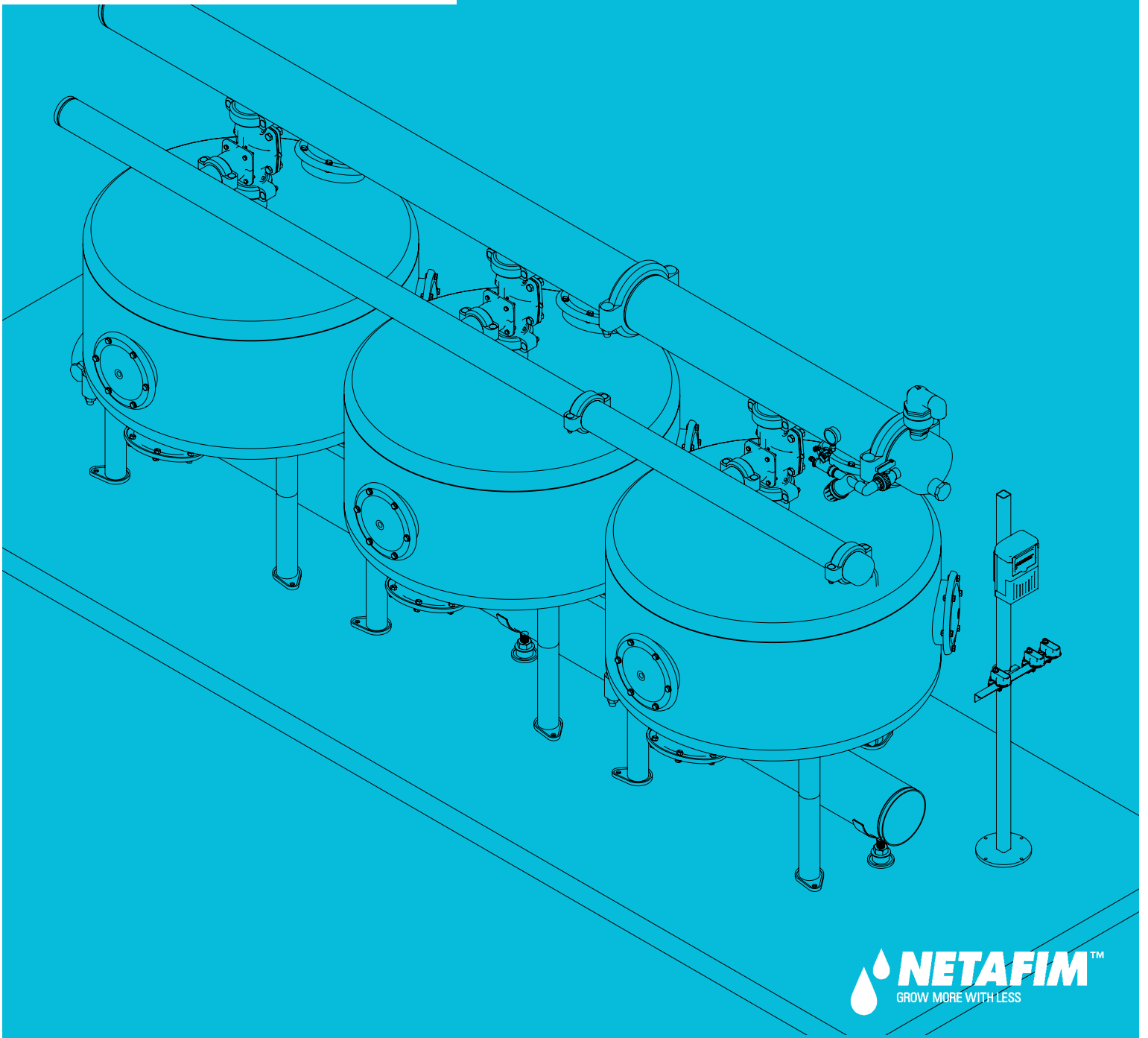

CONTENTS

Introduction

Aim of this manual	3
Safety instructions	3
General instructions	4
Components and structure	4
On-site pre-installation preparations	5
Tools required for installation	6
Grooved coupling connection	7

Installation

Installation add-ons (optional)	17
---------------------------------	----

Initial operation

	18
--	----

Troubleshooting

	20
--	----

Warranty

	21
--	----

© COPYRIGHT 2019, NETAFIM™

NO PARTS OF THIS PUBLICATION MAY BE REPRODUCED, STORED IN AN AUTOMATED DATA FILE OR MADE PUBLIC IN ANY FORM OR BY ANY MEANS, WHETHER ELECTRONIC, MECHANICAL, BY PHOTOCOPYING, RECORDING OR IN ANY OTHER MANNER WITHOUT PRIOR WRITTEN PERMISSION OF THE PUBLISHER.

ALTHOUGH NETAFIM™ TAKES THE GREATEST POSSIBLE CARE IN DESIGNING AND PRODUCING BOTH ITS PRODUCTS AND THE ASSOCIATED DOCUMENTATION, THEY MAY STILL INCLUDE FAULTS.

NETAFIM™ WILL NOT ACCEPT RESPONSIBILITY FOR DAMAGE RESULTING FROM THE USE OF NETAFIM'S PRODUCTS OR THE USE OF THIS MANUAL.

NETAFIM™ RESERVES THE RIGHT TO MAKE CHANGES AND IMPROVEMENTS TO ITS PRODUCTS AND/OR THE ASSOCIATED DOCUMENTATION WITHOUT PRIOR NOTICE.



FOREIGN LANGUAGES

In the event that you are reading this manual in a language other than English, you hereby acknowledge and agree that the English language version shall prevail in case of inconsistency or contradiction in interpretation or translation.

Aim of this manual

The aim of this manual is to provide the technician with general instructions for the installation of any configuration of the SandStorm™ metal single/double chamber sand filtration system.

All system components are shipped to the site packed in pallets and boxes with installation drawings, user manual and packing list.



NOTE

This manual describes the generic installation process of a SandStorm™ filtration system. The installation should be carried out in line with the installation drawings supplied with the system.

Safety instructions

Before handling any part of the system, carefully read the instructions and act accordingly.



NOTE

The maximum working pressure of the filtration system is 8 bar (116 PSI). (For filtration systems made to order, see the maximum working pressure in the Product Order).

Check and make sure the pumps and valves do not exceed the tolerances of the system and that they match the requirements of the system pressure and flow-rate specifications (see the documentation supplied with the system).



WARNING

Do not perform installation or maintenance operations or open filter ports before the pressure in the system is fully released. For draining purposes, open any valve downstream from the filtration system until the pressure is fully released. Check the pressure gauge to be sure it is at 0 before proceeding.



TIP

If a valve downstream from the filtration system is not available for pressure release, you can install a manual valve on the lower 2" socket of the outlet manifold end-cap.

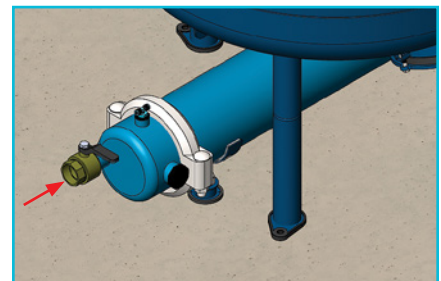

Electrical connections and wiring must be done by an authorized electrician only.

Be sure that prior to any maintenance procedures, all electrical connections to the system (AC controller, pumps, etc.) are unplugged.

Work only with proper standard tools (see [Tools required for installation](#), page 6).

Use only original parts supplied/approved by Netafim™.

INTRODUCTION

General instructions

- Installation must be performed by experienced and knowledgeable technicians.
- Consult your supervisor if problems occur during installation.
- Do not apply excessive force or pressure on components during installation.

Electricity

- AC controller only: Ensure that a suitable electrical power supply is available in the vicinity of the installation for electrical connection of the controller (see Electricity connection, page 5).
- An additional electrical socket should be available at the installation site for installation and service.

Components and structure

A media filtration system is comprised of the following components:

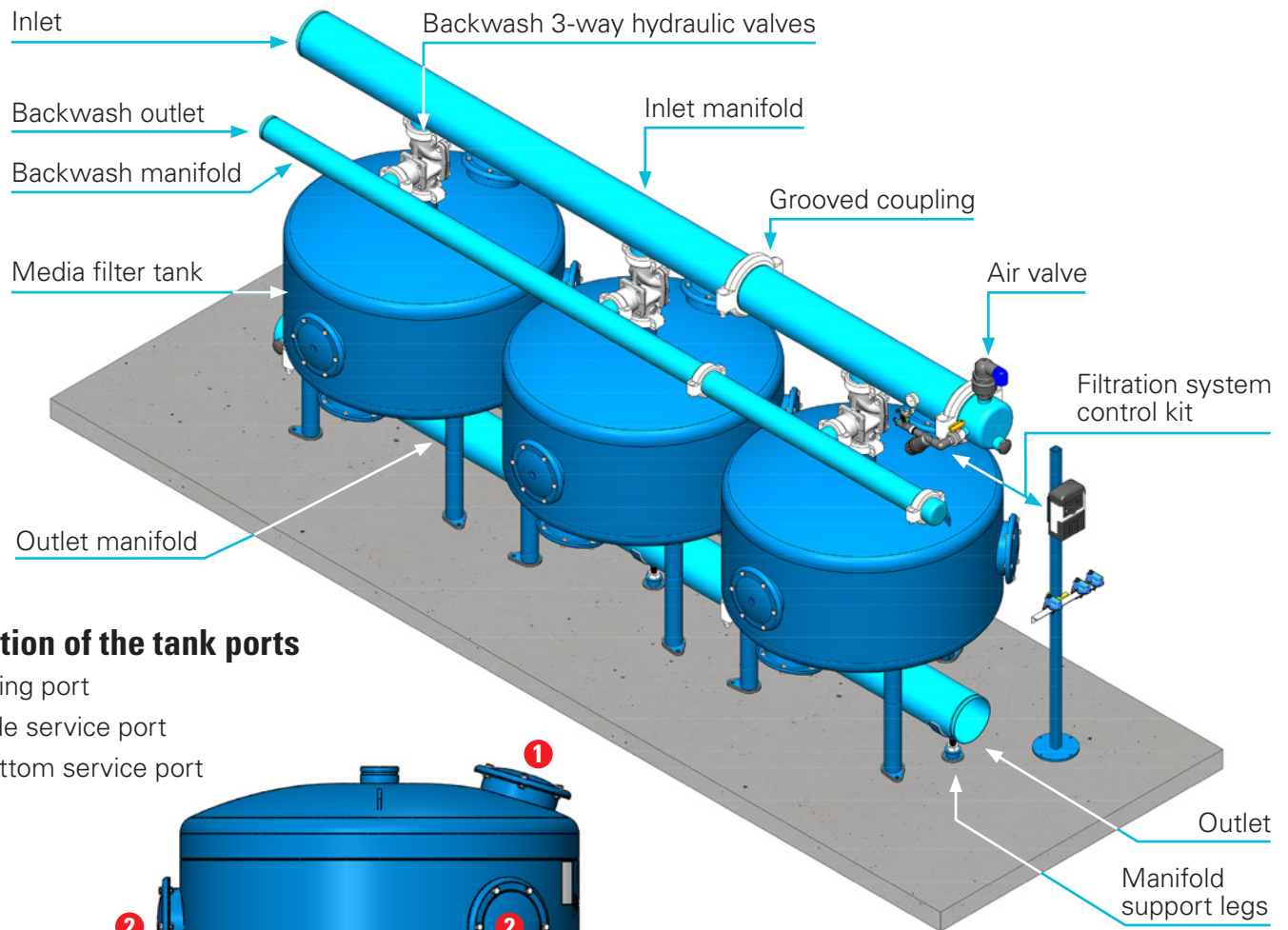

Location of the tank ports

- 1 Filling port
- 2 Side service port
- 3 Bottom service port

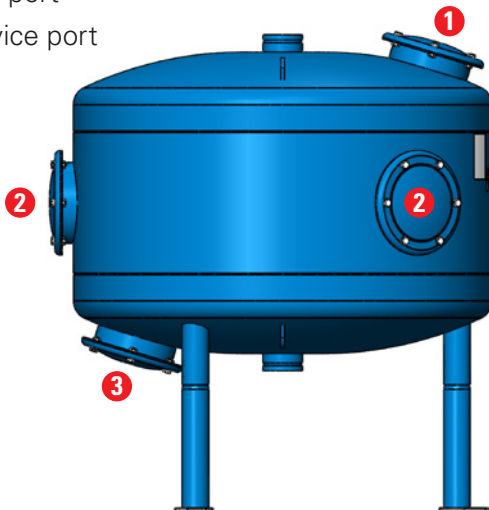

On-site pre-installation preparations

The following items should be set up on site before the installation of the filtration system.

Electricity connection

The BackFlush controller is supplied in either of two versions:

- 110-240v AC input - powered by an external 110-240v AC to 12v DC power supply.
Requires a mains electricity supply - 110-240v AC ~, 50/60 Hz 0.4 A Max.
Ensure that a suitable electrical power supply is available in the vicinity of the BackFlush controller.
The mains electricity supply should be equipped with a readily accessible circuit breaker, rated according to the BackFlush controller's total rated power for peak demand, certified as a branch circuit over current protector and compliant with the national code and requirements. Grounding connection: $\leq 10 \Omega$.
- 6v DC input - powered by 4 x 1.5v D-size alkaline batteries (not supplied).
Does not require a mains electricity supply.



NOTE

If the filtration system was not ordered with a BackFlush controller and is intended to be connected to an existing irrigation system controller, see the irrigation controller user manual for instructions.

Concrete slab construction

The sand filtration system will weigh anywhere from 250 kg up to a few tons. Planning the system foundation must include consideration of the total weight of the system when filled with sand and water.

The media filtration system should be installed on a concrete slab, at least 4" thick, with proper reinforcement and anchored to the ground.

The dimensions given in the table on the right are the **external filtration system dimensions** and not the concrete slab dimensions.

The minimum slab dimensions should allow a sufficient margin around the filtration system for service and maintenance.

The slab should have a slight grade to allow for water run-off, but not so steep that the manifold does not bolt together easily.

The soil all around the slab should be compacted to prevent erosion.

*Straight-line filtration systems

No. of tanks	External filtration system dimensions (length/width/height)	**Total system weight
	inch	lbs
tanks "30		
2	130/33/84	2204
3	177/33/84	3307
4	224/33/84	4409
5	271/33/84	5512
tanks "36		
2	130/36/86	3527
3	177/36/86	5291
4	224/36/86	7055
5	271/36/86	8819
tanks "48		
2	140/50/87	5732
3	192/50/87	8598
4	244/50/87	11464
5	296/50/87	14330

*For other filtration system configurations, contact your local Netafim™ representative.

**Filled with sand and water

INTRODUCTION

Backwash pipe

A pipe is necessary to take the backwash water from the backwash manifold back to the water source (comply with your local regulations) or to the closest drainage ditch.

In order not to limit backwash flow rate:

- The backwash pipe should be no longer than 20 m (65 ft).
- The pipe diameter should never be smaller than the backwash manifold diameter.
- If the backwash pipe length is 33 ft or less, it should be of the same diameter as the backwash manifold.
- If the backwash pipe is longer than 33 ft, its diameter should be larger than the backwash manifold.
- The pipe should not ascend above the elevation of the flushing manifold outlet.

Tools required for installation

- No special tools are needed. A standard full installer toolkit is adequate.
- To connect the control stand to the concrete slab, an electric hammering drill and a concrete drill bit.
- To connect grooved couplings, the following wrenches are required:

Grooved coupling size		Bolt and nut size (mm)	Wrench size (mm)
(inches)	(mm)		
2	50	M10	17
3	80	M12	19
4	100	M12	19
6	150	M16	24
8	200	M20	30
10	250	M22	34

Grooved coupling connection

All the main filtration system parts are connected with grooved couplings.

To connect a grooved coupling:

- a. Slide the rubber gasket onto the end of one of the pipes to be connected.

Apply a dedicated lubricant or liquid soap to the coupling rubber gasket to facilitate insertion.

- b. Place the end of the other pipe to be connected so that it touches the end of the first pipe, and slide the rubber gasket over the end of the second pipe. The rubber gasket should cover the end of both pipes equally, leaving the groove of each pipe exposed.

- c. Place the two housing elements around the rubber gasket. Make sure the rims of the housing elements are inserted into the grooves all around both pipes.

- d. Put the bolts and nuts in place and close them to a tight fit, but do not fasten them yet.

- e. When you are satisfied that the connected parts are properly positioned and the connections are properly aligned, fasten the two nuts alternately until the coupling is evenly tightened around both pipes.

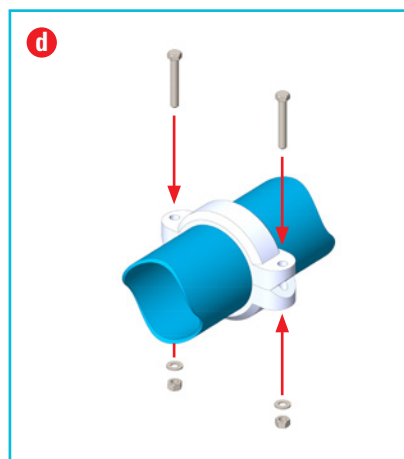
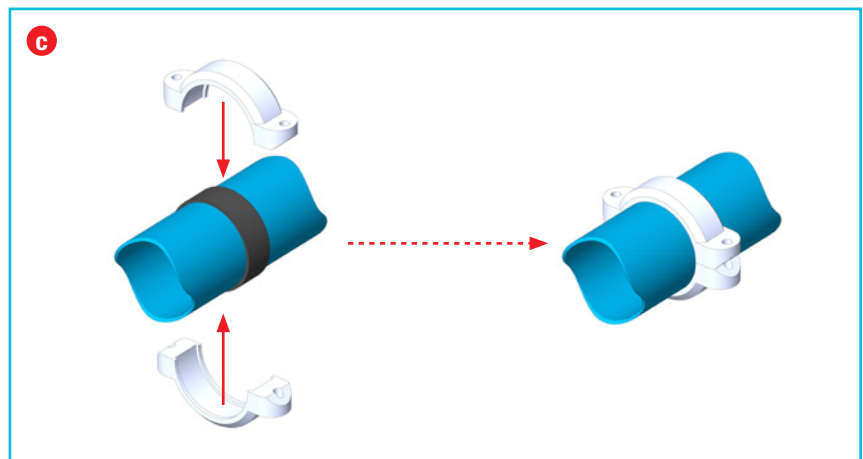
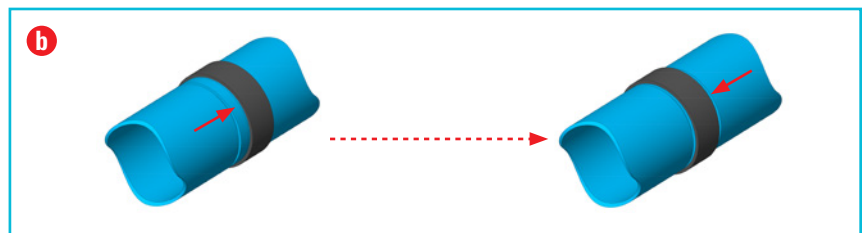
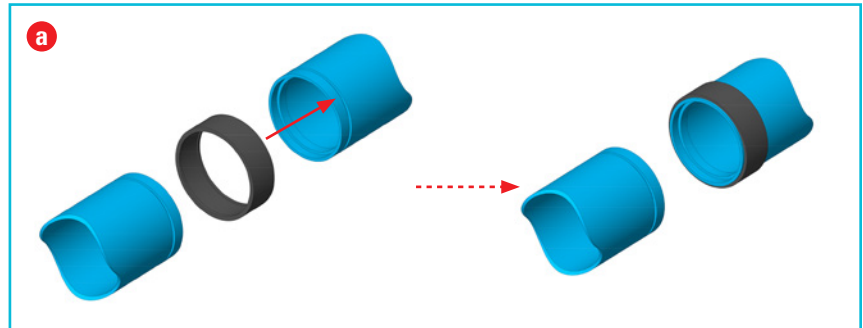

INSTALLATION

This chapter describes the generic installation process of a SandStorm™ filtration system. The installation should be carried out in line with the installation drawings supplied with the system.

1. Align the gravel tanks on the platform according to the dimensions in the following table

Tank size (inches)	(Distance between tanks - center to center* (a) (inches)
30	47.24
36	47.24
48	51.97

*The distances in this table are for straight-line systems. For the distance between adjacent rows of tanks in other system configurations, see the installation drawings supplied with the system.

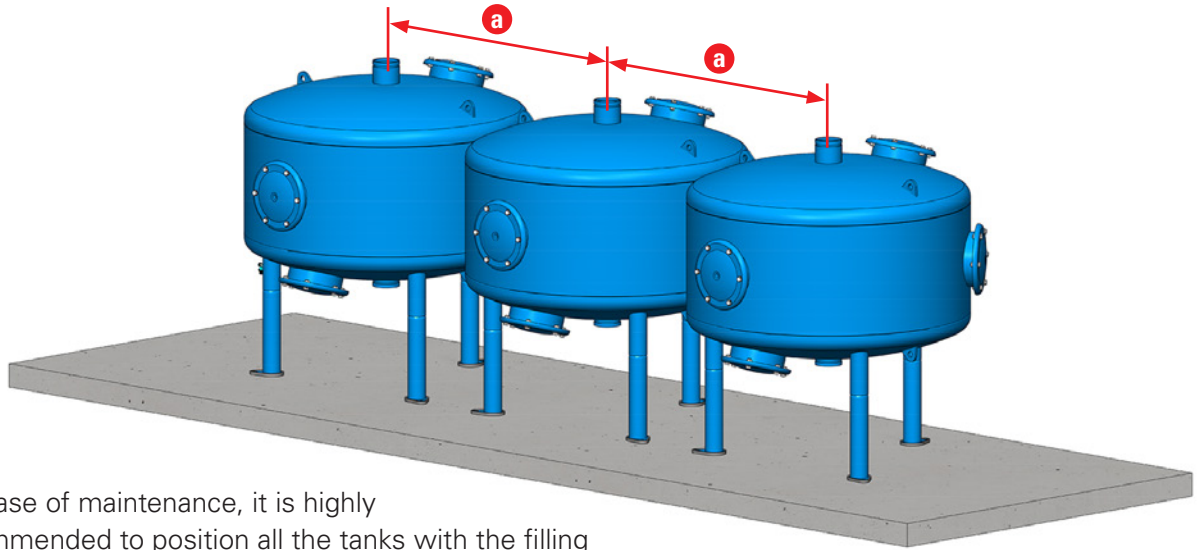

NOTE

For ease of maintenance, it is highly recommended to position all the tanks with the filling ports and service ports, respectively, pointing in the same direction.

2. Connect a backwash valve to each tank inlet with a grooved coupling (see the [Grooved coupling connection](#) instructions, page 7). Be sure that the position of the backwash valves is per the flow arrows marked on the valve.

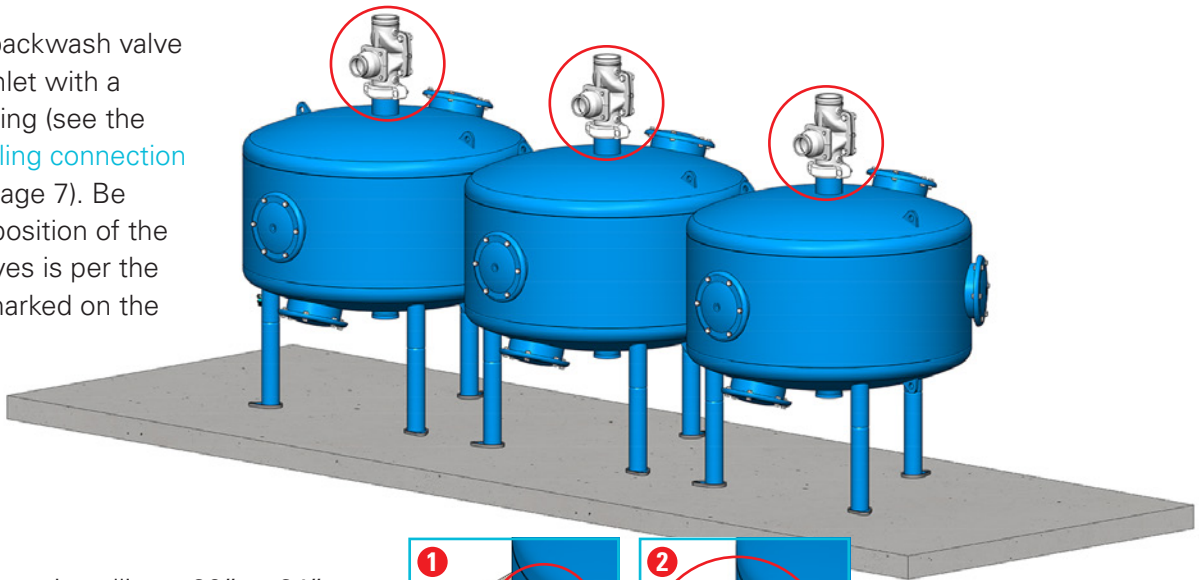

NOTE

If you are installing a 20" or 24" tank filtration system:

1. Connect a nipple to each tank inlet.
2. Connect a valve to each nipple.

Proceed with the installation.

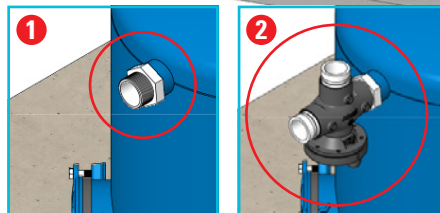



NOTE

The manifolds are supported by support legs. Each support leg should be installed immediately after installing the part it supports. Place the support legs according to their quantity and locations in the system installation drawings. Use the long support legs to support the inlet manifold, the medium legs to support the backwash manifold and the short legs to support the outlet manifold.

3. Connect the inlet manifold to the backwash valves and the inlet manifold sections to each other with grooved couplings.

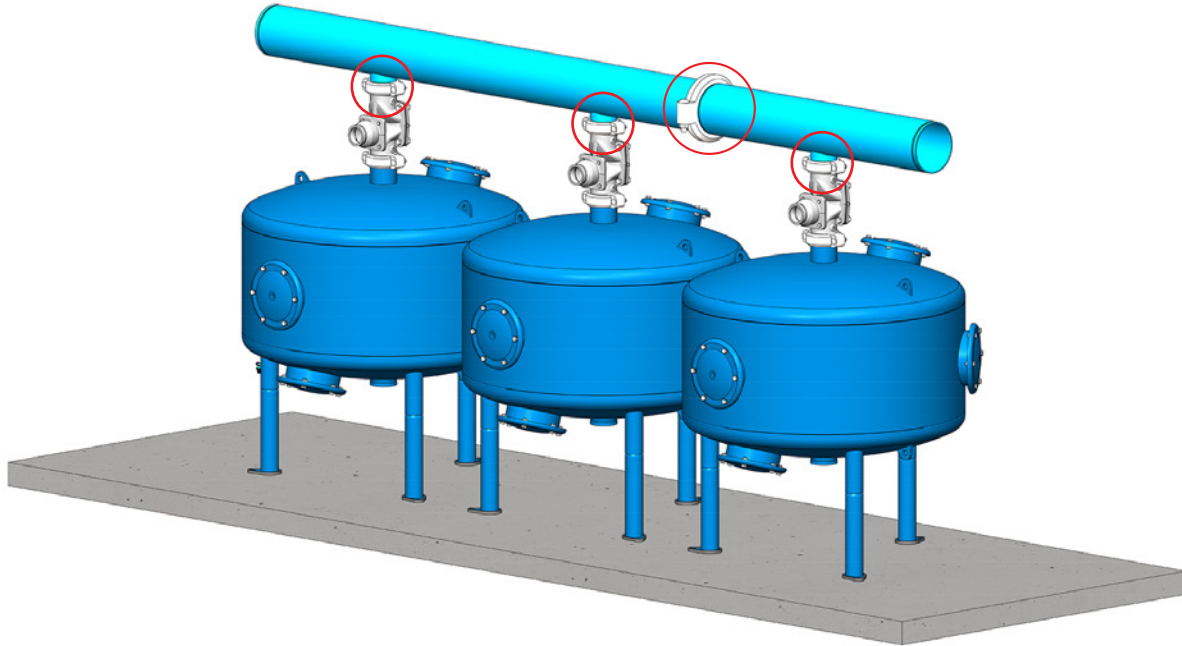

4. Connect the backwash manifold to the backwash valves and the backwash manifold sections to each other with grooved couplings.

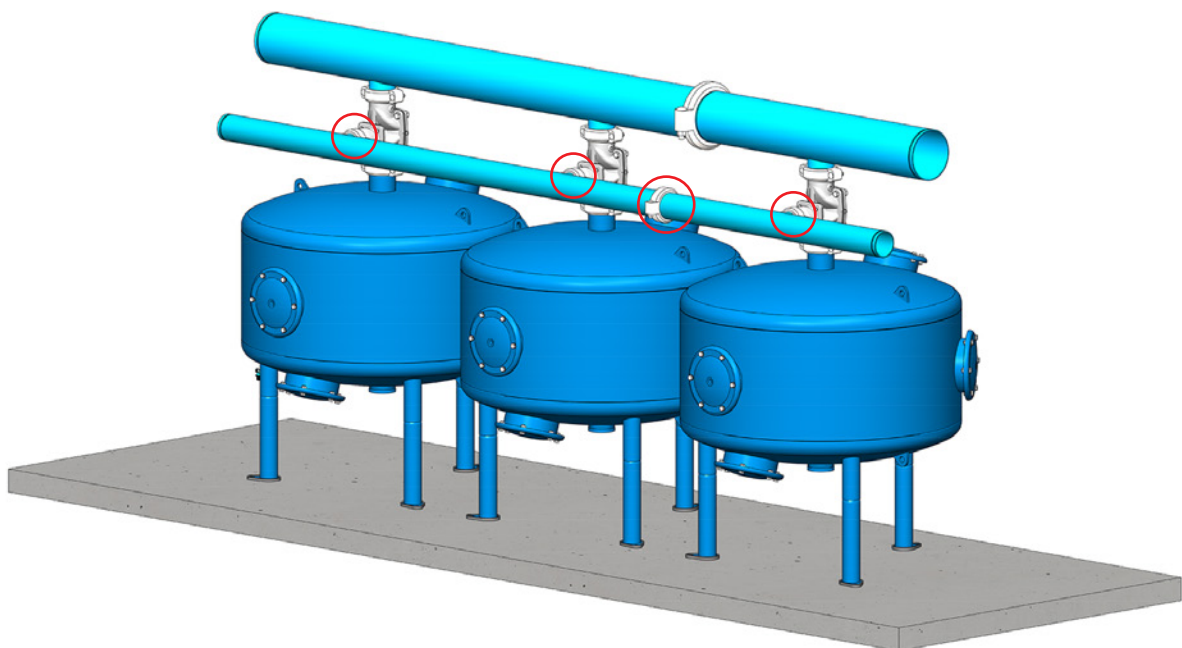

INSTALLATION

5. Connect the outlet manifold to the outlets of the tanks and the outlet manifold sections to each other with grooved couplings.

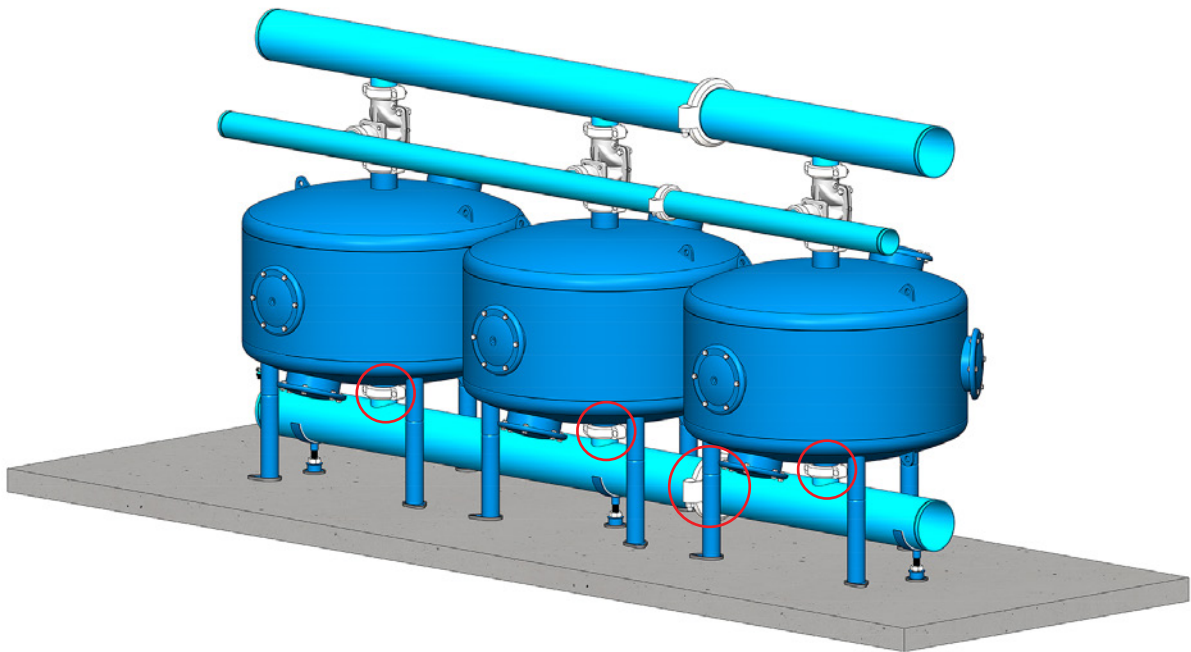

6. Check and confirm that the position of the system is where it should be relative to the inlet and outlet main pipelines. Readjust the filtration system location if needed.
7. Connect the end-cap to the backwash manifold with a grooved coupling.

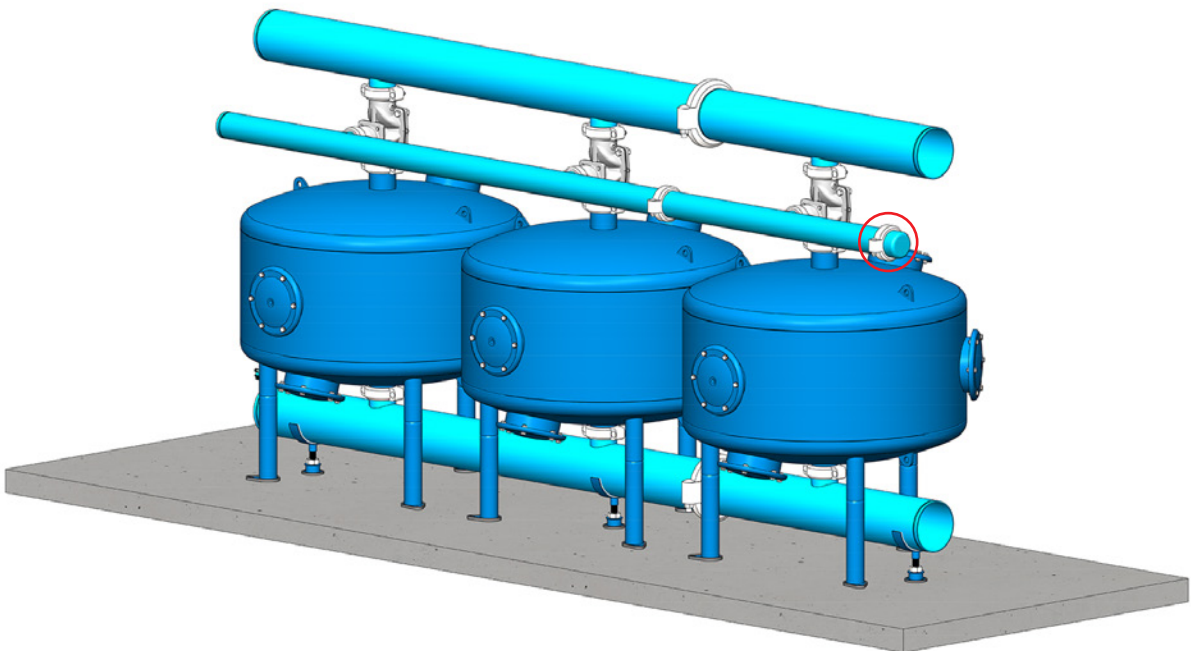

8. Connect the end-cap to the inlet manifold with a grooved coupling. Make sure that the end-cap is placed with the socket for the air valve pointing upwards and the socket for the control assembly pointing sideways.

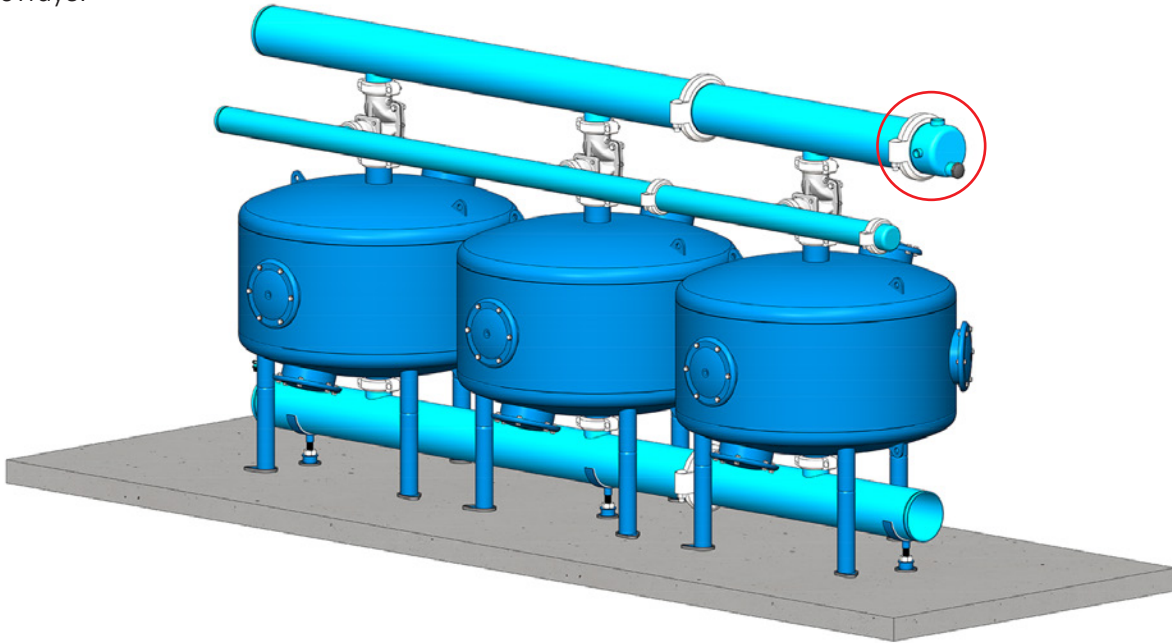

9. Connect the end-cap to the outlet manifold with a grooved coupling. Make sure that the end-cap is placed with the 1" outlet pointing upwards.

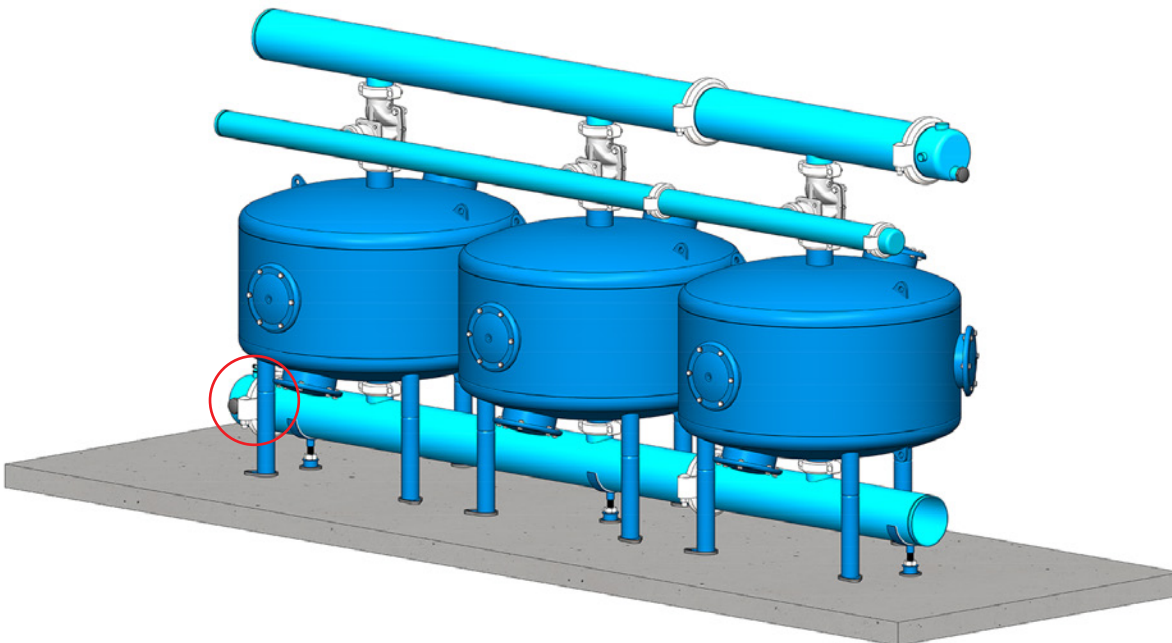

10. Make sure that all the grooved coupling connections are properly aligned.
11. Fasten all the grooved couplings. Fasten the two nuts of each grooved coupling alternately until the coupling is evenly tightened around both pipes (see [Grooved coupling connection](#), page 7).

INSTALLATION

13. Connect the control assembly to the socket on the side of the inlet manifold end-cap.

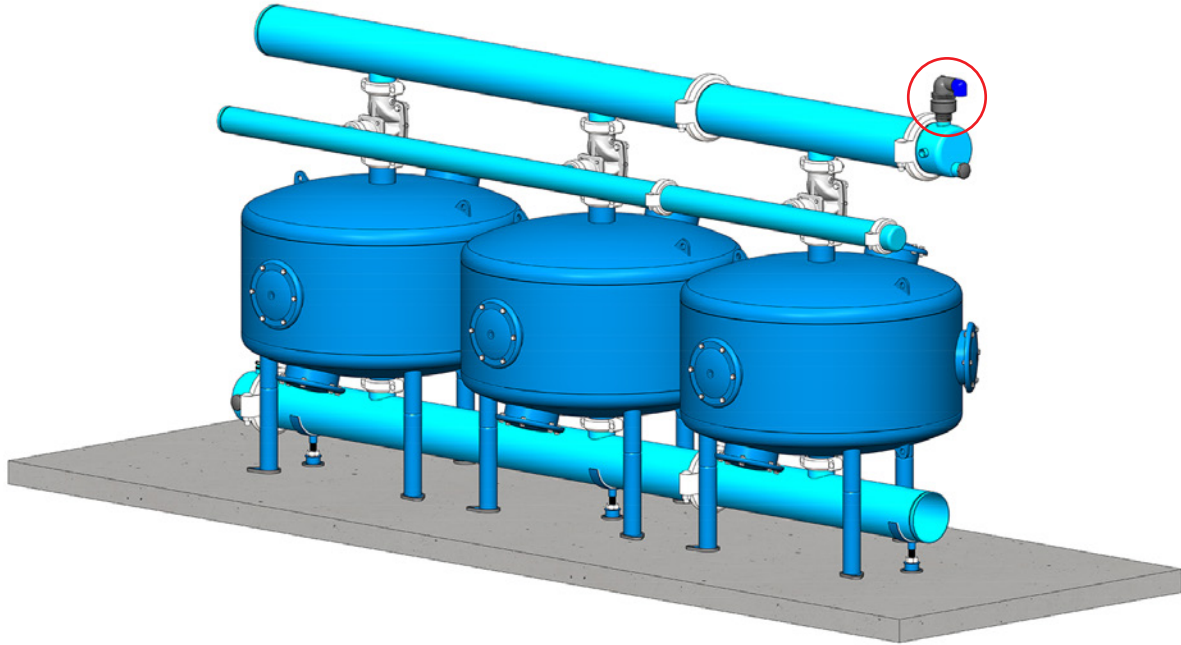

12. Connect the air valve to the socket on the top of the inlet manifold end-cap.

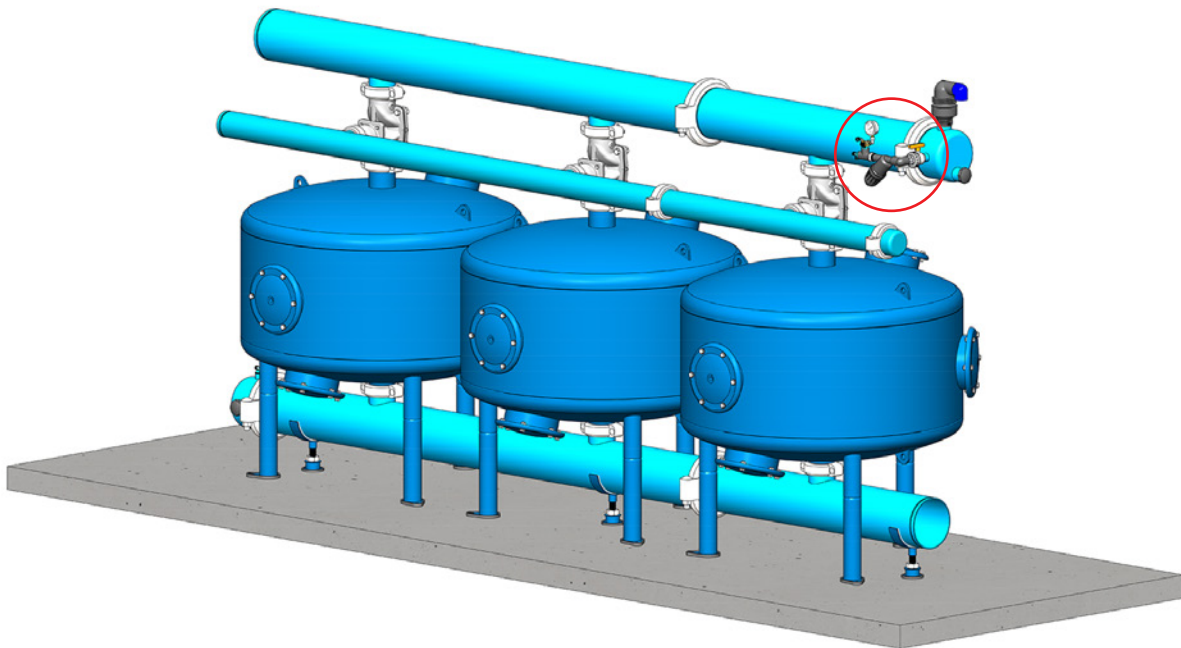

14. Place the stand of the backwash controller so that it is close to the control assembly (make sure it meets your needs for both operation and maintenance). Secure it to the concrete slab with 10 mm spreading anchor bolts.

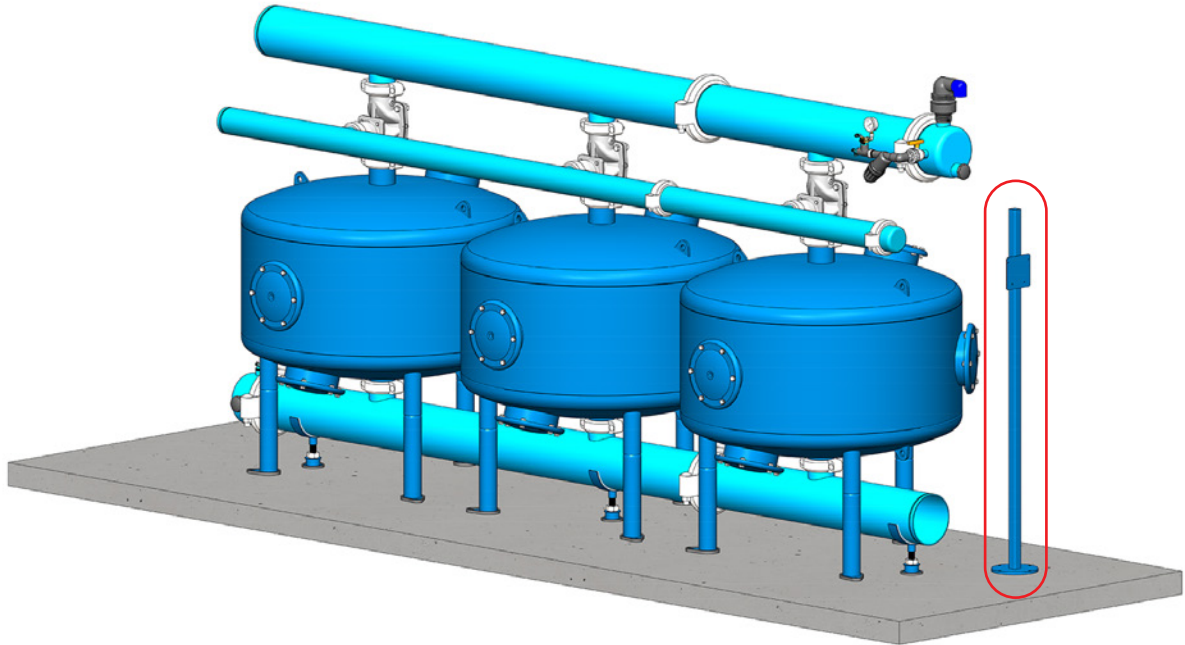

NOTE

There are 2 solenoid placement options:

- A. All the solenoids are placed on the solenoid bracket on the controller stand.
 - B. Each solenoid is placed on its respective backwash valve.
- Perform steps 15 and 16 on the next page according to the planned solenoid location.

INSTALLATION

A. All the solenoids are placed on the solenoid bracket on the controller stand:

15. Secure the BackFlush controller and the solenoid bracket in place on the stand.

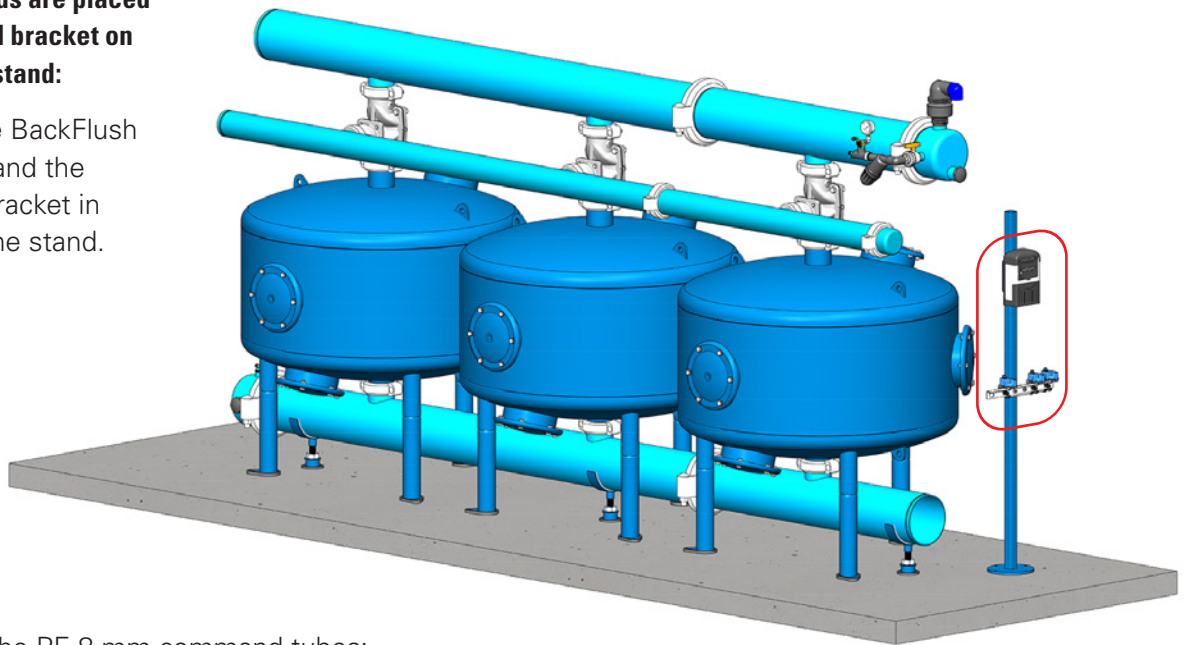

16. Connect the PE 8 mm command tubes:

- a. From the low pressure point in the BackFlush controller to the low pressure point socket on the end-cap of the outlet manifold of the gravel filtration system (find the accessories in the control kit).
- b. From one of the outlets on the 3-way ball valve of the control kit to the low pressure point socket on the end-cap of the outlet manifold (find the accessories in the control kit).
- c. From the outlet of the water control kit to the common "live pressure" inlets of the solenoids.
- d. From the outlet of the water control kit to the high pressure point of the BackFlush controller.
- e. From each solenoid command outlet to one of the hydraulic backwash valves, in order of sequence.
- f. Connect a drain tube (no more than 7 ft) to the common vent of the solenoids.
- g. Secure the PE 8 mm command tubes with plastic zip ties in an organized and tidy fashion along the filtration system.

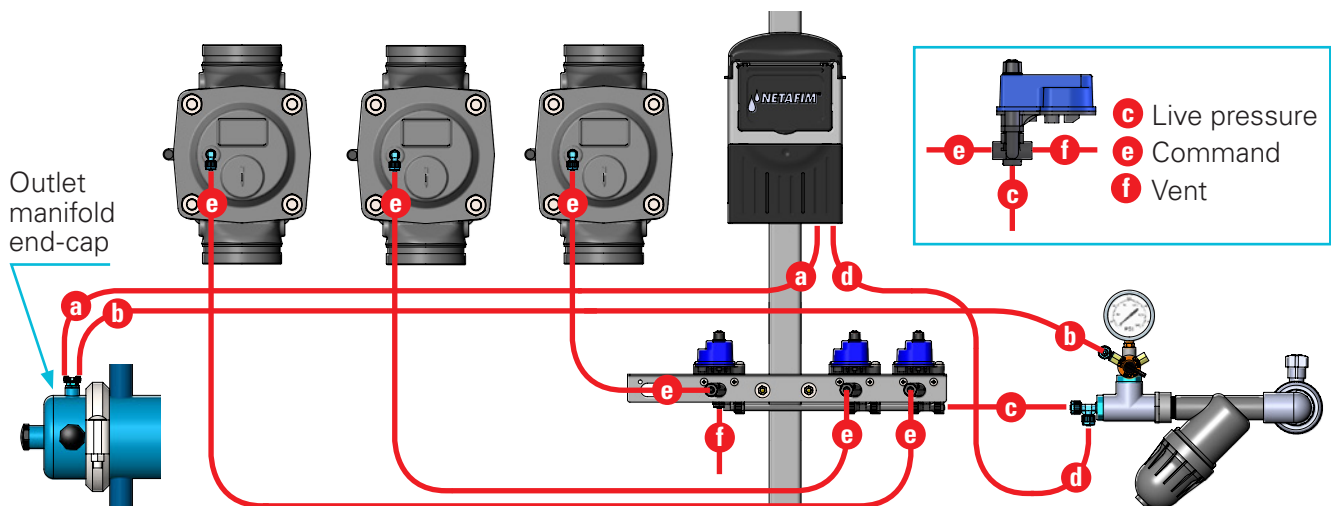

B. Each solenoid is placed on its respective backwash valve:

15. Secure the BackFlush controller in place on the stand.

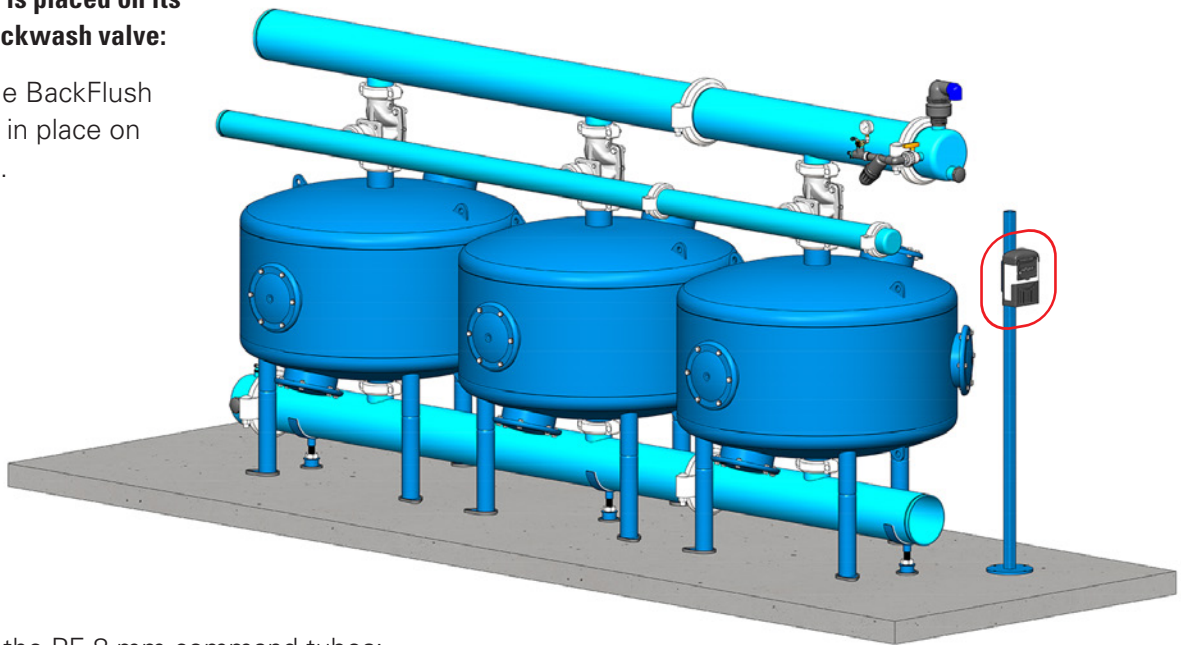

16. Connect the PE 8 mm command tubes:

- a. From the low pressure point in the BackFlush controller to the low pressure point socket on the end-cap of the outlet manifold of the gravel filtration system (find the accessories in the control kit).
- b. From one of the outlets on the 3-way ball valve of the control kit to the low pressure point socket on the end-cap of the outlet manifold (find the accessories in the control kit).
- c. From the outlet of the water control kit, concatenate to the common “live pressure” inlets of all the solenoids.
- d. From the outlet of the water control kit to the high pressure point of the BackFlush controller.
- e. From each solenoid command outlet to its hydraulic backwash valve.
- f. Connect a drain tube (no more than 7 ft) to the common vent of each solenoid.
- g. Secure the PE 8 mm command tubes with plastic zip ties in an organized and tidy fashion along the filtration system.

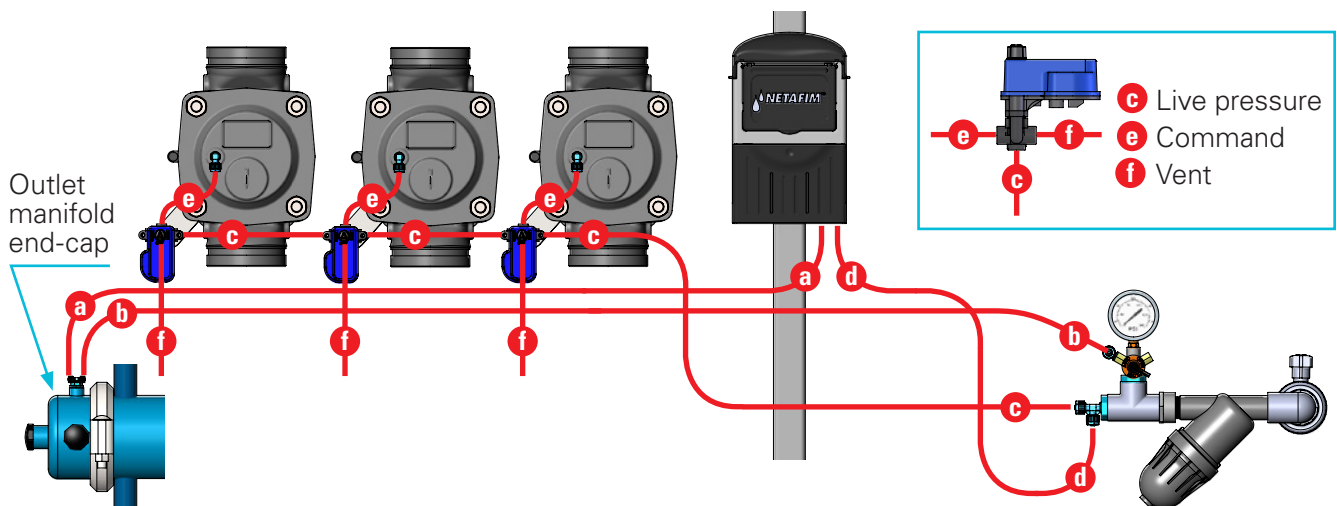

INSTALLATION

17. Connect the solenoids to the BackFlush controller expansion cards ordered in sequence, from left to right. Red wire = + / black wire = common (inverting wire polarity will change NC to NO).

ATTENTION
The solenoids must be of the 12v DC latching type.

- Connect 2 solenoids to each expansion card.
- If there is an odd number of filters in the system, connect the last one as illustrated.

NOTE
If each solenoid is placed on its respective backwash valve, secure the cables with plastic zip ties in an organized and tidy fashion along the filtration system.

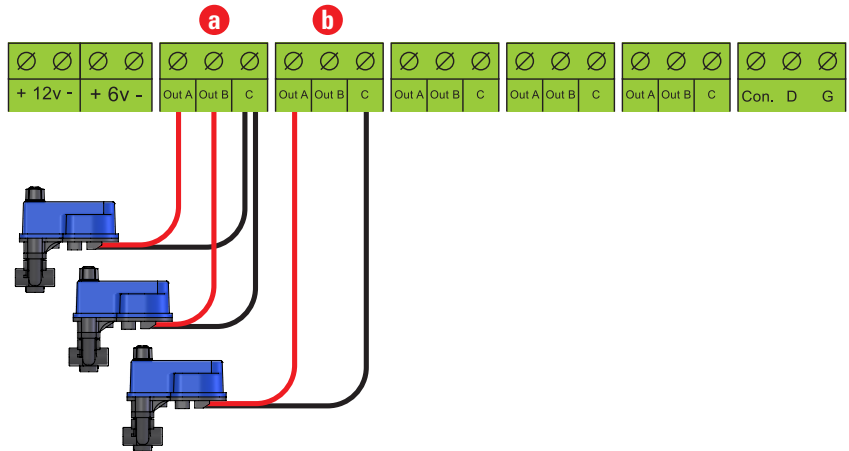

(For full instructions, see the BackFlush controller manual).

NOTE
If the filtration system was not ordered with a BackFlush controller and is intended to be connected to an existing irrigation system controller, see the irrigation controller user manual for instructions.

18. Connect the BackFlush controller to the electricity source:

- For controllers powered by an external 12v DC power supply

WARNING
When operating the controller with the external power supply, make sure there are no batteries in the battery tray.

- Connect the external 110-240v AC to 12v DC power supply to the BackFlush controller 12v DC input. Red wire = + / black wire = -.
- Connect the power supply to a water-resistant socket.

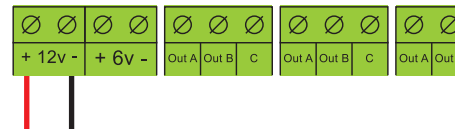

- For controllers powered by 4 x 1.5v D-size alkaline batteries (6v DC)

- Connect the battery tray to the BackFlush controller 6v DC input.
- Insert the batteries. Match the poles to the markings inside the battery tray.

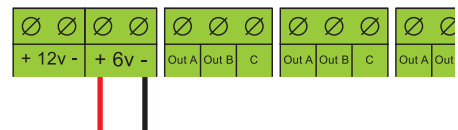

(For full instructions, see the BackFlush controller manual).

NOTE
If the filtration system was not ordered with a BackFlush controller and is intended to be connected to an existing irrigation system controller, see the irrigation controller user manual for instructions.

19. Close all the openings of the manifold end-caps with the 2" plugs supplied with the control kit.
20. Connect the filtration system inlet and outlet to the main irrigation line with grooved couplings.
21. Connect the backwash pipe to the backwash manifold with grooved couplings.
22. Visually check (with the aid of a flashlight) the inside of all the tanks, through the filling port, for damaged, missing or unsecured under-drain diffusers ("flutes"). Replace, re-fit, re-connect and re-secure if necessary.



ATTENTION

Before filling the tanks with media

Fill each tank with water up to a third of its height with a hose through the filling port adding media, to prevent damage to the under-drain diffusers when pouring the media.

23. Fill the tanks with media through the filling port. Fill each tank up to the media level marker on the filter tank.

Single-chamber

Tank diameter (inches)	Sand quantity* (lbs)
30	700
36	1000
48	1900

Double-chamber

Tank diameter (inches)	Sand quantity* (lbs)
16	200
20	260
24	400

*Crushed silica sand. Quantity may vary depending on manufacturer specifications.

Silica Sand Media Data

Media type	Mesh range	Mean effective size
Crushed Silica 12	130 - 80	1.2mm - 1.1
Standard Sand 6/20	140 - 100	1.0mm - 0.9
Crushed Silica 16	200 - 155	0.7mm - 0.6
U.S. Silica 80	200 - 160	0.7mm - 0.6
Crushed Silica 20	230 - 170	0.5mm - 0.45

24. Flatten the surface of the media.
25. Make sure that the filling port and its gasket are clear of any remaining gravel particles and close the filling port.

Install add-ons (optional)

- It is recommended to install a secondary (screen) filter on the main line, downstream from the media filtration system.
- It is recommended to install a manual isolation valve downstream from the media filtration system for maintenance purposes.

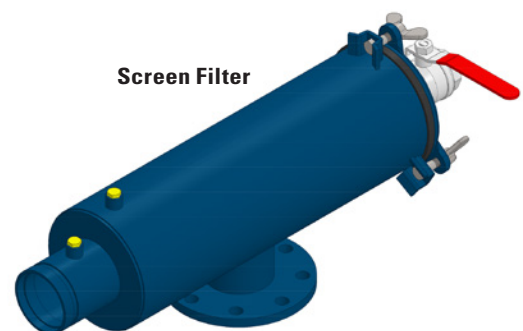

Screen Filter

INITIAL OPERATION

1. Set the BackFlush controller

The controller is equipped with an LCD display and 4 keys, as displayed below. When the unit is left untouched for a minute, the display switches off and a beep is heard every 20 seconds to indicate it is working.

Holding down any of the keys for a few seconds will bring the screen back to life.

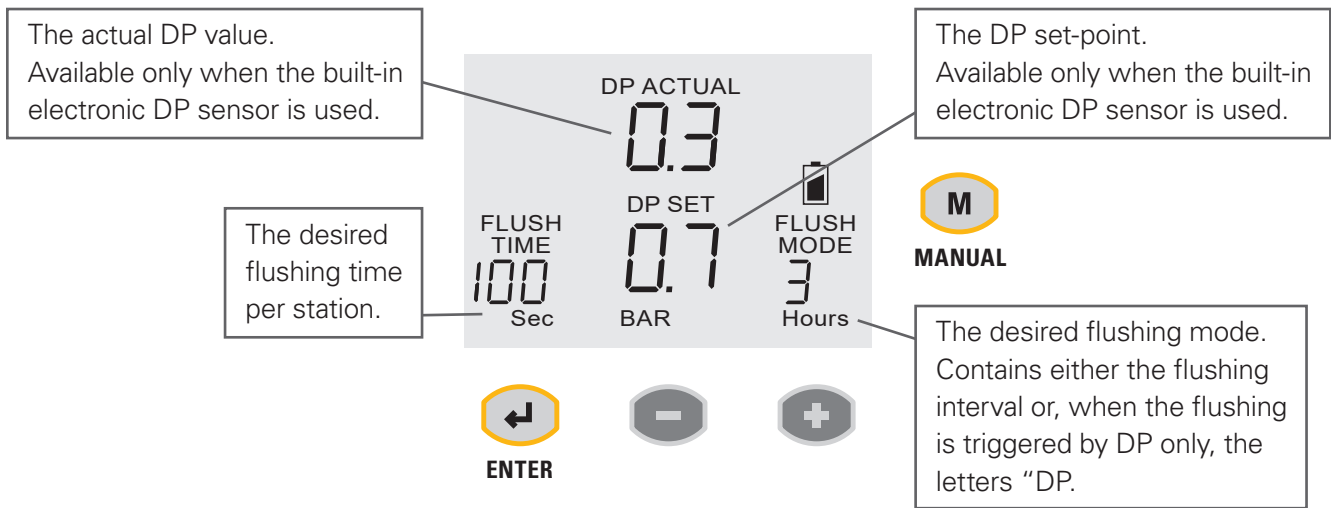

The screen consists of several fields. Some of them are editable and some of them are not.

To enter the EDIT MODE, press the key. The EDIT MODE is indicated by blinking of the currently editable field.

Each time you press the key, the next editable field becomes active and starts blinking.

Use the and keys to change the value in the active field.

Press the key again to set the selected value for the current field and move to the next editable field.





To return to a previous field during the process of passing through the editable fields, press the key repeatedly until you get back to the FLUSH TIME field, and there are blinking fields. You can then begin the process again.

Configuration

Parameter	Definition	Action
Main valve (sustaining valve)	The pre-dwell delay between the main valve opening and the opening of station 1	Select: YES if exists Enter: 20 sec
Dwell time	The backwashing delay between stations	Enter: 10 sec
DP delay	The delay during which the DP sensor reading is expected to remain stable before reaction	Enter: 10 sec
Looping limit	The number of consecutive flushing cycles triggered by the DP sensor before deciding that there is an endless looping problem	Enter: 3
Alarm	Allocates one output for alarm activation	Select: YES
Delay valve	Allocates one output for delay-valve activation	Select: YES if exists

(continued on the next page)

INITIAL OPERATION



Parameter	Definition	Action
View outputs	This is a special mode that enables the user to review the list of outputs and their allocations. The output number is displayed in the bottom left corner and its allocated function appears in large letters in the center of the screen.	Use the  key to toggle between NO and YES and confirm by pressing the  key. Keep using the  key to review the list
Pressure units	Select the units to be used for pressure measurement	Select: BAR or PSI
Calibration	Zero calibration of the built-in electronic DP sensor	Disconnect the sensor ports from the command tube and open them; to atmospheric pressure then select calibration: YES
Version display	Displays the controller's software version-number	No action required. Press the  key twice to proceed
Flush time	The desired flushing time per station	Enter: 100 sec
DP set-point	The pressure difference between the filter's inlet and outlet that initiates a flushing cycle	Enter: 0.7 bar or 10 PSI
Flush mode	The flushing interval or, when the flushing is "triggered by DP only, the letters "DP"	Enter: 3 hours

(For full instructions, see the BackFlush controller manual.)



NOTE

If the filtration system was not ordered with a BackFlush controller and is used with an existing irrigation system controller, see your irrigation controller user manual for instructions.

2. Turn on the water and start irrigation.
3. As soon as the system is pressurized and stable, start a manual backwashing cycle by pressing the  key. The  icon will appear on the display (to manually terminate a backwashing cycle in progress, press the  key again).
4. After completion of a full backwashing cycle, check that the filtration system DP is within the operational range (0.15-0.4 bar/2.2-5.8 PSI, depending on the flow rate). Toggle the control kit 3-way ball valve and note the filtration system inlet and outlet pressure. Subtract the outlet pressure from the inlet pressure. The result is the filtration system DP.
5. Check all the filtration system connections for water leaks – re-fit, re-connect and re-secure if necessary.
6. Check all the command tube connections for leaks – re-fit, re-connect and re-secure if necessary.
7. Check that the backwashing cycle is performed in the correct order and that all the filters in the system are backwashed in sequence.
8. Check the secondary filter (if installed) for the presence of gravel.



NOTE

If a secondary filter is not installed, disconnect the mainline pipe downstream from the filtration system, let the water flow to the ground and visually check for the presence of gravel. If gravel is present, see Troubleshooting, page 20.



ATTENTION

Steps 2 to 8 above should be performed whenever the operation of the filtration system is resumed after being idle (i.e., after seasonal shutdown, maintenance or troubleshooting operations).

TROUBLESHOOTING



WARNING

Do not perform maintenance operations or open filter ports before the pressure in the system is fully released. For draining purposes, open any valve downstream from the filtration system until the pressure is fully released. Check the pressure gauge to be sure it is at 0 before proceeding. Alternatively, you can open the valve installed on the outlet manifold end-cap - if installed (see TIP, page 3).

If the flushing cycle does not start but the controller is initiating the flushing signal and the solenoids are reacting (“clicking”):

1. Check the command filter in the control assembly. Clean it if necessary and perform manual flushing.
2. Check for clogging inside the solenoid valves - clean if possible or replace with a new solenoid.
3. Check for clogging of the hydraulic control tubes - open the clogs and clean if necessary.
4. Check for a ruptured or defective hydraulic control tube - replace if necessary.

If the media is running out through the outlet manifold during filtration:

1. Depressurize the system.
2. Disconnect the outlet manifold and visually identify which filter tank is losing gravel.
Alternatively, you can open the filling ports of the tanks, one by one, and visually identify the tank in which the media level has dropped.



ATTENTION

There may be more than one tank losing gravel.

3. Empty the media from the tank/s and replace the damaged under-drain diffuser/s (“flutes”) inside the tank/s.
4. Refill the tank with media (see instructions in the Installation chapter, steps 23-25, page 17).

If the media is running out through the backwash manifold during backwash:

1. Adjust the backwash flow-control valve on the backwash manifold.
 - If a manual backwash flow-control valve is installed, throttle the valve to reduce the flow until the media stops running out.
 - If a hydraulic backwash flow-control valve is installed, the valve is factory pre-set to the required flow rate.

In the rare case that the backwash flow-control valve requires fine-tuning:

- a. Release the pilot lock-nut.
- b. Gently rotate the pilot calibration bolt counterclockwise with a wrench to reduce the flow until the media stops running out.
- c. Retighten the pilot lock-nut.
2. Check the level of media inside the filters.
 - If the level is lower than the media level marker on the filter tank - add media.
 - If the level is higher than the media level marker on the filter tank - remove media.

Netafim™ warrants all the components of the SandStorm™/SandStorm™ NC media filter system to be free of defects in material and workmanship for 5 (five) years from the date of installation.

Netafim™ warrants the SandStorm™/SandStorm™ NC controller and Aquative solenoids to be free of defects in material and workmanship for 1 (one) year from the date of installation.

If a defect is discovered during the applicable warranty period, Netafim™ will repair or replace, at its discretion, the product or the defective part.

This warranty does not extend to repairs, adjustments or replacements of a SandStorm™/SandStorm™ NC media filter system or part that results from reasonable wear and tear, misuse, negligence, alteration, force majeure, lightning, power surge, improper installation or improper maintenance.

If a defect arises in your Netafim™ product during the warranty period, contact your local Netafim™ representative.

Limited warranty

This warranty is subject to the conditions in Netafim's official warranty statement.

(For the full text of Netafim's official warranty statement, please contact your local Netafim™ representative).





GROW MORE WITH LESS

NETAFIM USA
5470 E. HOME AVE.
FRESNO, CA 93727
CS 888 638 2346
www.netafimusa.com

SSIM 07/22