



GrowSphere™ **MAX**

Irrigation & Fertigation Controller

Quick Setup Guide

July 2024



Precision
Agriculture





Technical Resources

Thank you for purchasing the **GrowSphere™ MAX** Controller, an intuitive and simple-to-use device designed to speak the language of growers.

GrowSphere™ MAX regulates water and fertilizer delivery in a precision irrigation system, activating local and remote devices such as pumps, valves, filters, dosing pumps and other hydraulic components. This ensures that crops receive the optimal amount of water and nutrients at all times.

This **GrowSphere™ MAX** quick guide contains basic setup instructions and wiring diagrams for your convenience.

Contents

Internal Design	4
Local and Remote Control	8
GrowSphere™ MAX - Basic Settings	13
System preferences	14
System settings	16
Wiring Instructions	20
Expansion modules	21
Connect to remote units	23
Dosing Setting	27
Create irrigation program	34

© Copyright 2024, NETAFIM™

No parts of this publication may be reproduced, stored in an automated data file or made public in any form or by any means, whether electronic, mechanical, by photocopying, recording or in any other manner without prior written permission of the publisher.

Although NETAFIM™ takes the greatest possible care in designing and producing both its products and the associated documentation, they may still include faults.

NETAFIM™ will not accept responsibility for damage resulting from use of netafim's products or use of this manual.

NETAFIM™ reserves the right to make changes and improvements to its products and/or the associated documentation without prior notice.

Internal Design

GrowSphere™ MAX - Internal Design

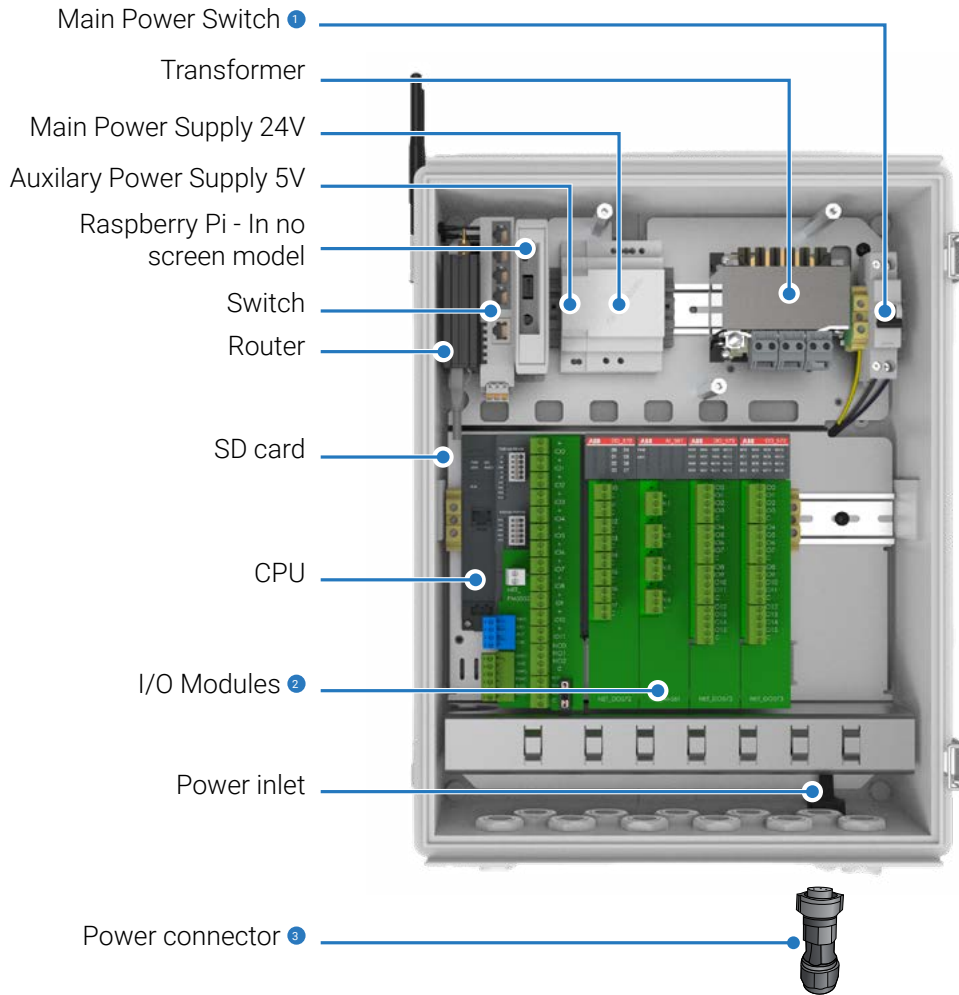

- ❶ Switches the main power on and off
- ❷ Enable connecting the peripheral components
- ❸ You can find the connector in the accessories box

* Subject to product configuration

GrowSphere™ MAX - CPU

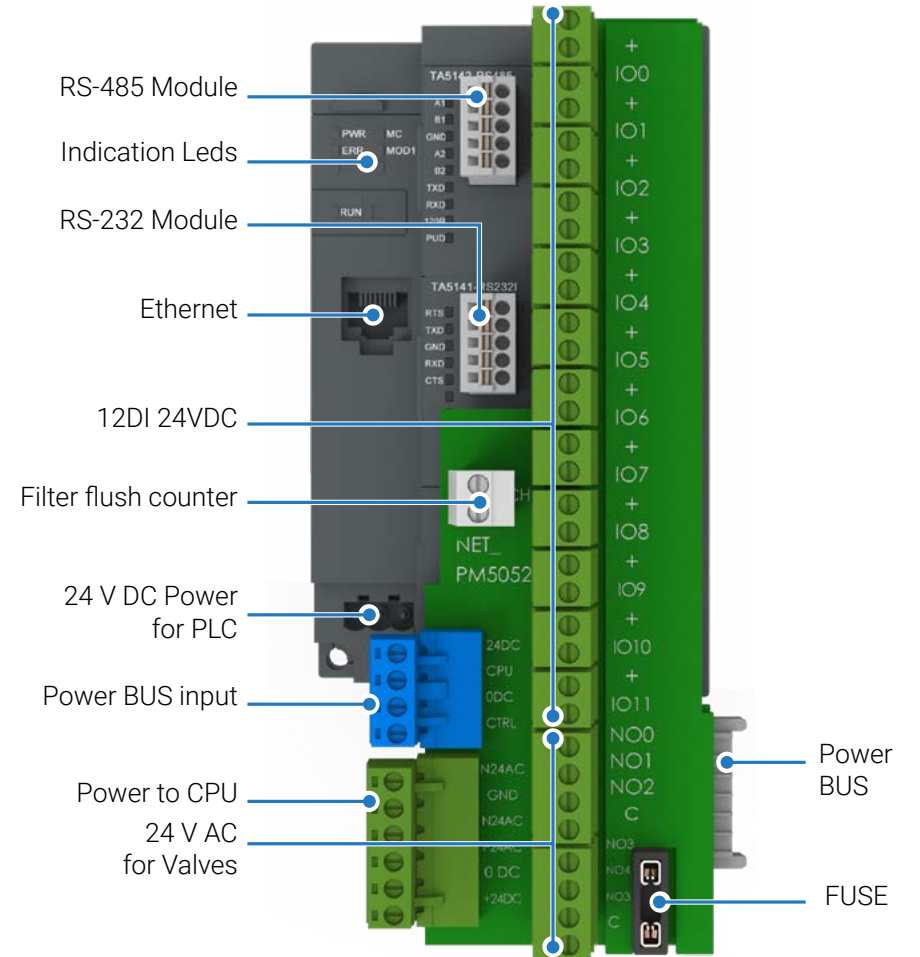



Adaptor features

- AC protection Fuse
- CPU Remote reset
- Controlled by Modem remotely
- Easy visual Indication
- 24AC LED
- 24DC LED
- CPU Reset

Custom ABB controller

- Memory 80MB

What's in the box

	<p>GrowSphere™ MAX controller</p>
	<p>3 x (colors) gaskets for power cable</p>
	<p>1 x BSU feed cable</p>
	<p>1 x electricity connector</p>
	<p>Wall mount adaptors</p>
	<p>Wall mount screws</p>
	<p>SIM adaptors and pin</p>
	<p>2 x fuses</p>
	<p>2 x mobile antenna</p>
	<p>Plastic bands</p>
	<p>Global SIM Card</p>
	<p>1 x Touch screen pen</p>

GrowSphere™ MAX Power connector

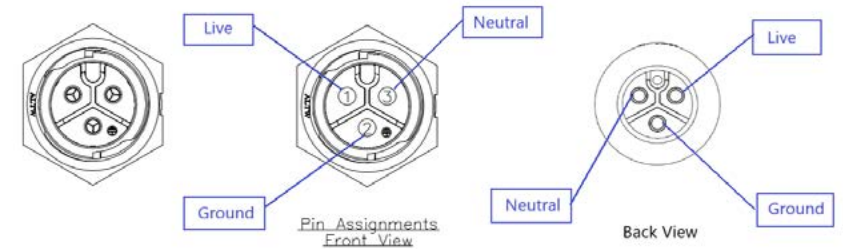

GrowSphere™ MAX Cable connector

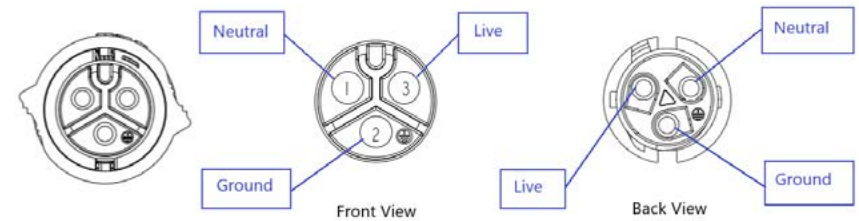

Firmware upgrade (Manual)

To upgrade the firmware in your GrowSphere™ MAX controller, follow these steps below. Remember to stay up to date with future firmware versions.

1. Turn OFF GS Max, takeout existing SD Card
2. Prepare a clean SD card formatted with FAT32
3. Download required latest version. Unzip it to a folder.
4. Copy only the content of the folder into SD card root.
5. The SD card contents should look like:



6. Insert this SD card into PLC
7. Power ON the PLC.
8. If a new FW is found on the SD card, RUN and ERR LEDs will start blinking in 1 HZ
9. Wait ~5min until only the RUN LED is blinking.
10. Power OFF the PLC .

11. Take out the SD card and insert SD card that was taken out from PLC before upgrade or it may be empty card.
12. Power ON the PLC.
13. The controller will reboot once again automatically, wait the process to complete. When the process complete, the RUN LED should remain constantly on. When the process complete, the RUN LED should remain constantly on.
14. if the process is successful RUN LED should be constantly on (ERR LED might be red, that is OK , MC LED will be ON, if SD Card is inserted in the slot).

Product technical specifications

	Per mainline	Total
Mainline	1	4
Main valve	1	4
Main water meter	1	4
Pump	3	12
External filter (flushing control+indication)	32	128
Dosing station	1	4
Dosing channel	8	8
Valves	256	256

Irrigation programs	10
Shifts per program	32
Valves per shift	32
Dosing recipe	10

Local and Remote Control

Local access via LAN

For local access, you can connect to the controller' Wi-Fi by scanning the QR code on the controller or connect via LAN. To access remotely, you can use GrowSphere™ Cloud by clicking on the link icon or use Anydesk from any device by entering the username and password provided with the controller.

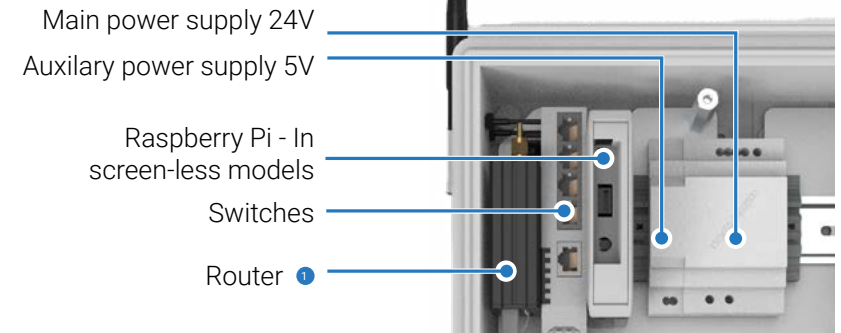

1. Connect a LAN cable to the switch and type the IP address 192.168.0.10 in the URL
2. Create static IP address – In the address IP range of my system 192.168.0.4
3. Ensure the Default gateway address is: 192.168.0. 10

Navigate to your ethernet port properties and set the TCP/IPv4 option, as demonstrated below

To easily find your Ethernet port, navigate to the Control Panel > Network and Sharing Center > Change adapter settings

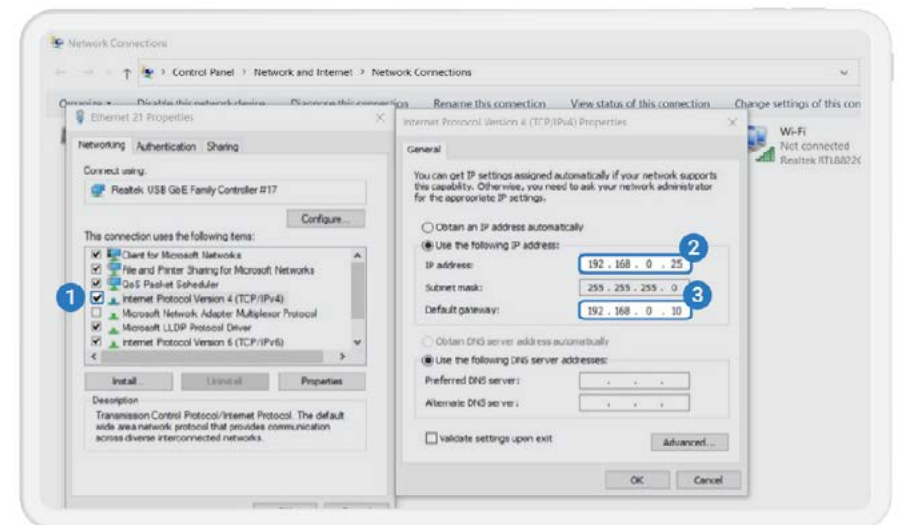

Local access via WiFi

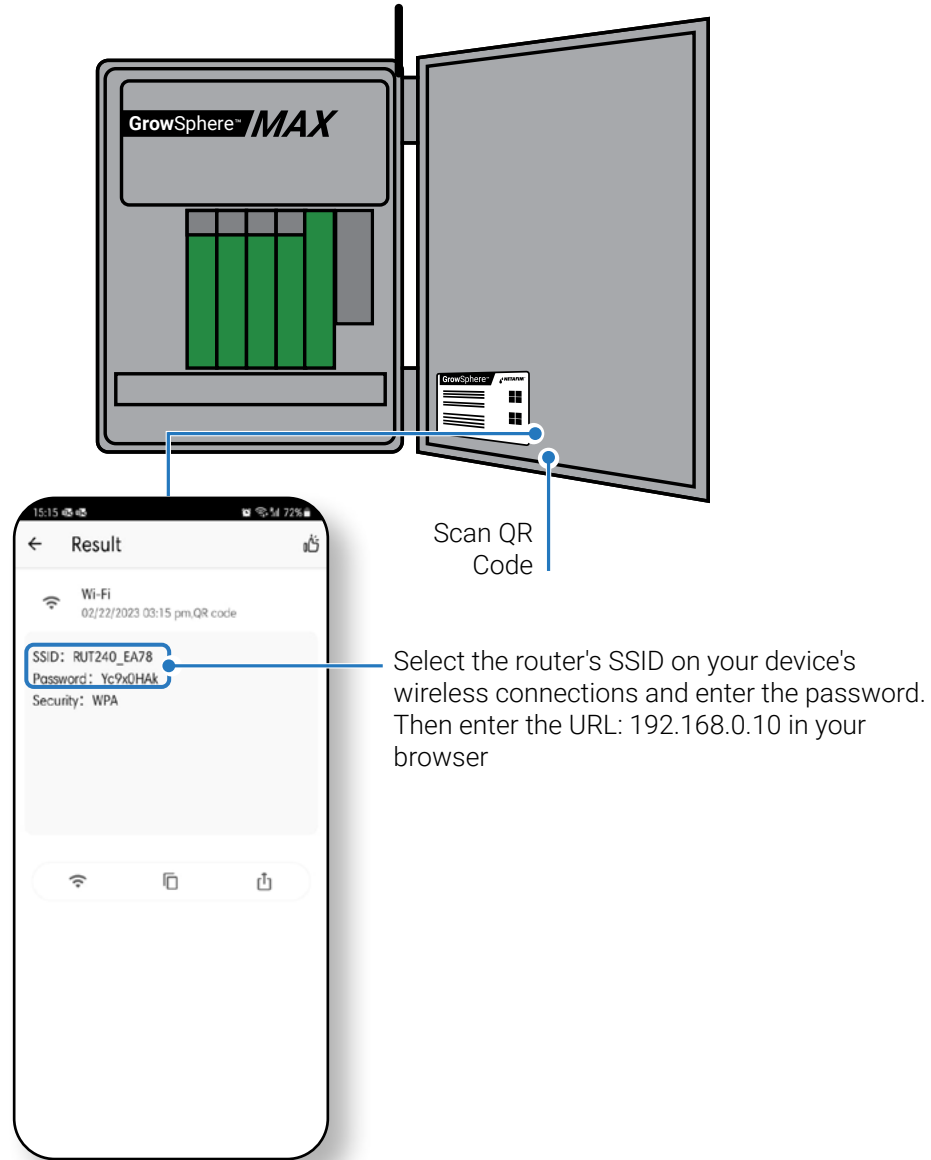

- By scanning the QR code on the controller you will get the Wi-Fi address and password for the controller's modem
- By typing 192.168.0.10 in the URL line, you will be able to access to the controller dashboard.



Remote access - Using Anydesk

The controller comes with a SIM card and can be accessed through the **GrowSphere™** Cloud. However, you can also access it through AnyDesk by following these two steps:

To get started, you'll need to install Anydesk on your computer, tablet, or mobile device. Once you have it installed, you can use the username found on the controller's internal door. The password for this account is GrowSphere01.



GrowSphere™ MAX - Basic Settings

Getting started

Select the Desktop / Mobile view, in the case of Tablet, you can select Desktop

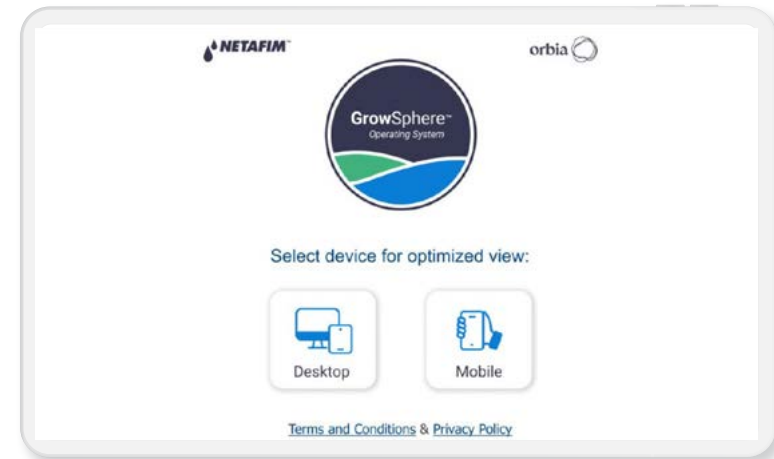

System preferences

Set your system preferences

Set your preferences and continue to the next step, your settings will be saved automatically.

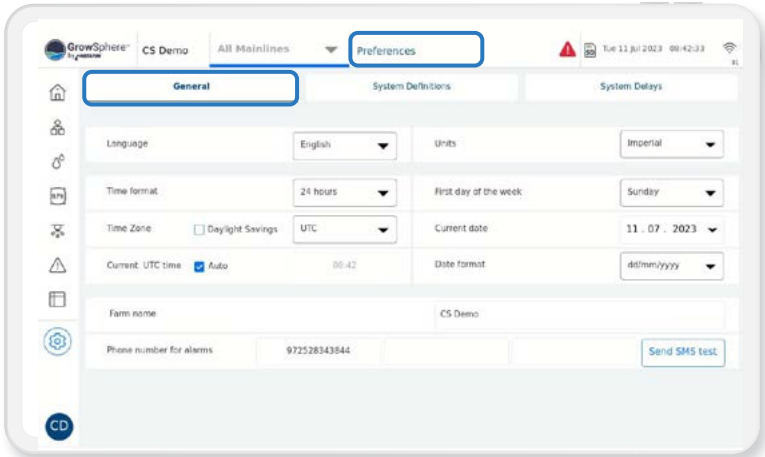

Set definitions for operation time and flow

Select the relevant mainline - From this stage, all the settings will be per mainline.

Set the System Definitions

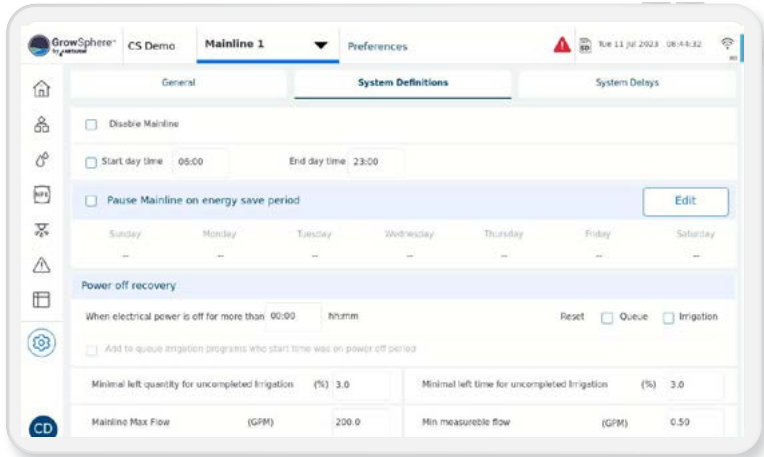

Define system delays

Set the delays for the mainline components

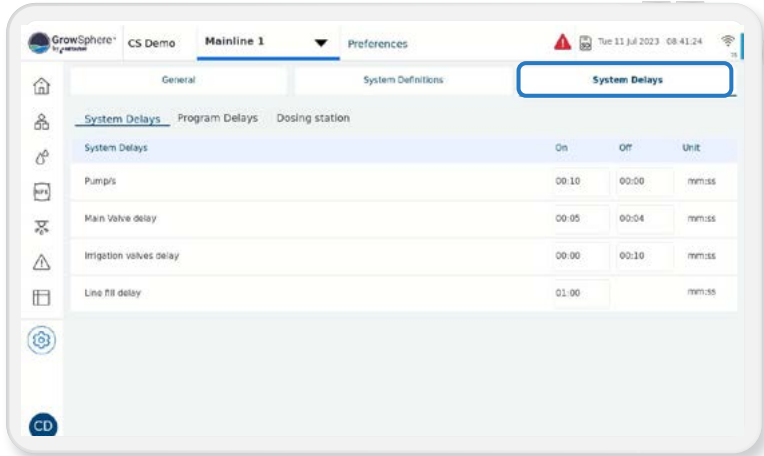

System settings

Navigate to settings

Enter the password 287451

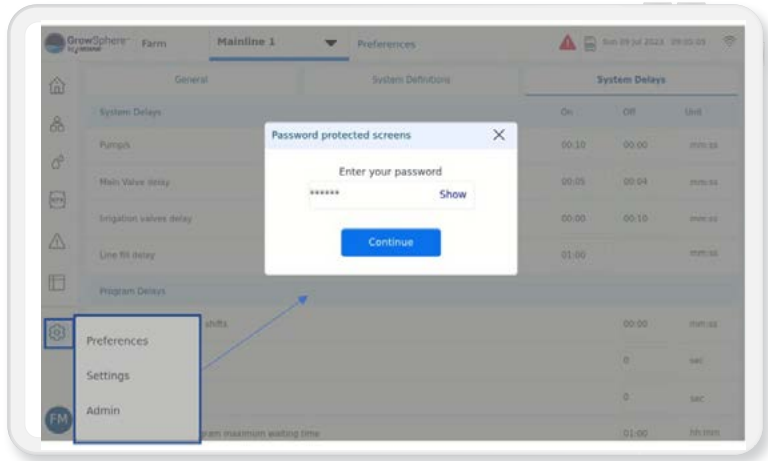

Set mainlines configuration

Define the number of valves and the devices that connected to each mainlines

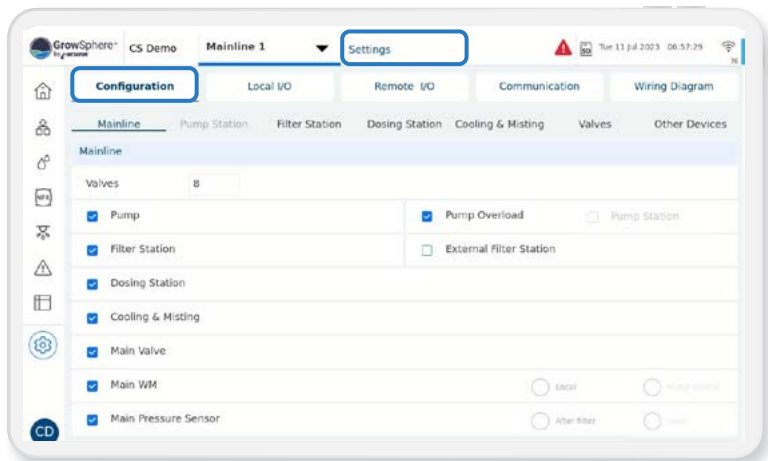

Set valves configurations

- Set name, flow rate, and irrigated area for each valve
- The Flow and Area are used to manage and monitor the irrigation in the **GrowSphere™** cloud

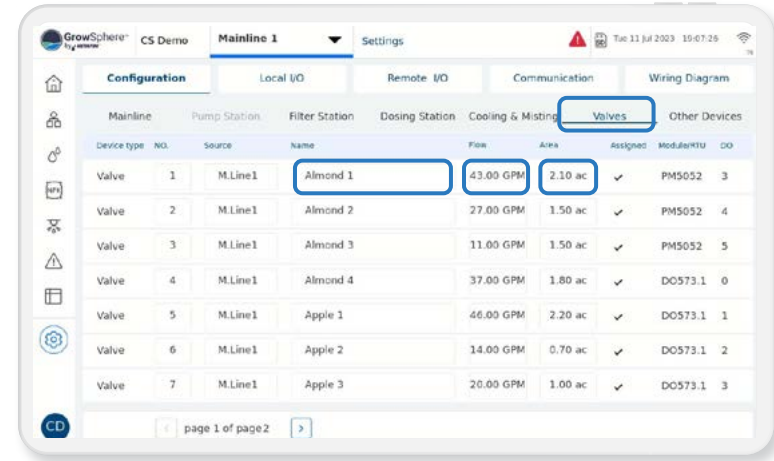

Define other devices configurations

Set the parameters for each device

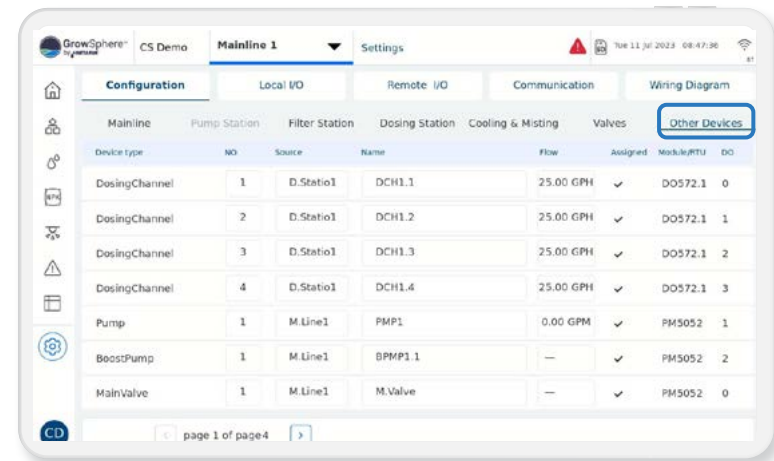

Assign digital outputs to I/O modules

- 1 Click assign for each row to assign
- 2 Define the Flow and irrigated area for each valve
- 3 The I/O module to which the device has been assigned to can be selected, by skip between pages 1-5

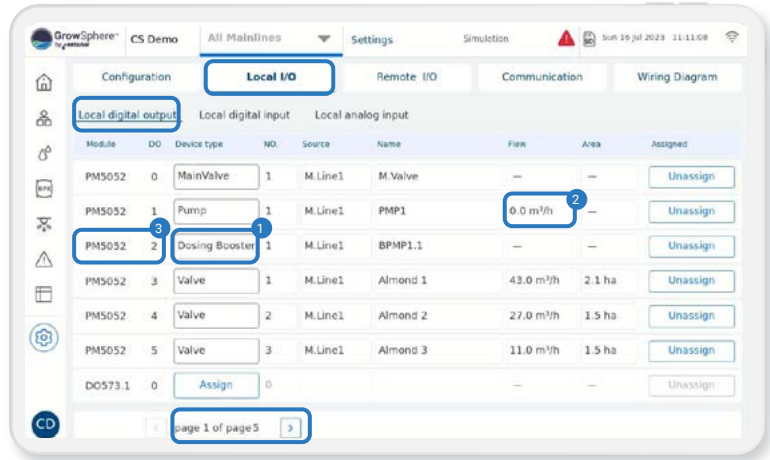

Assign digital inputs to I/O module

- Assign each device to I/O Module and port
- Provide the name, flow rate, and irrigated area for each input.
- You can select the I/O module to which the device has been assigned to by navigating between pages 1-5.

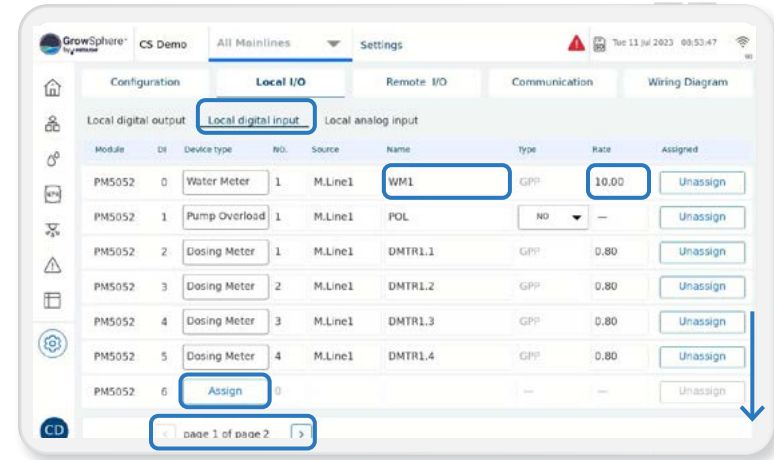

Assign digital outputs to I/O modules

By clicking Assign, the system will indicate how many devices are not yet assigned, and will automatically assign it to the next available port

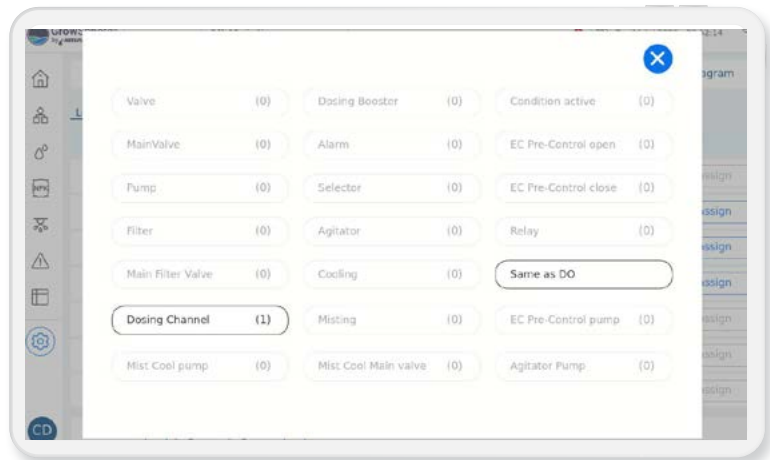

View the wiring diagram

The wiring diagram shows the module and port for each device that has been assigned. You can follow the diagram to properly connect the devices

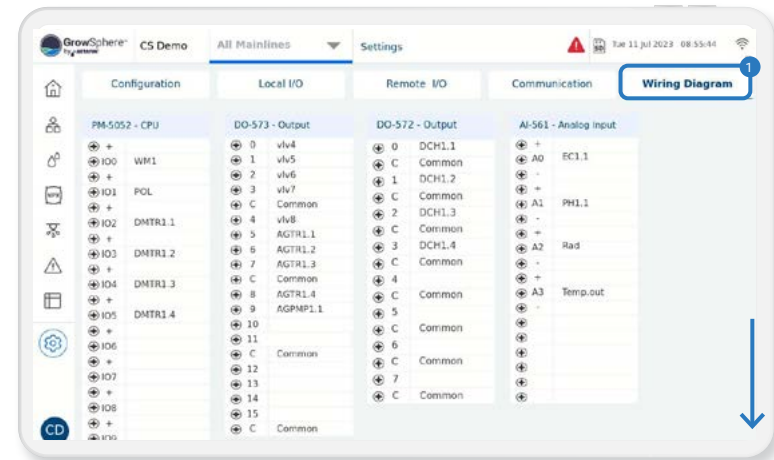

Wiring Instructions

GrowSphere™ MAX - CPU

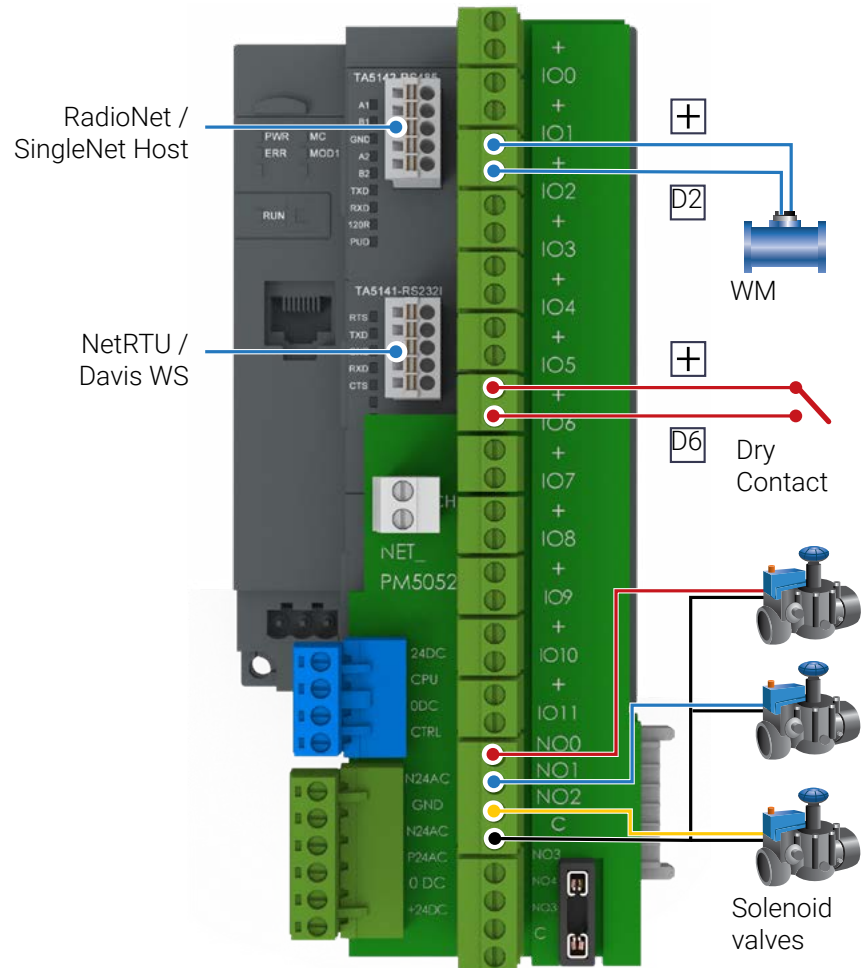

Expansion modules

GrowSphere™ MAX - DO573 Module

- 16 normally open relay outputs
- Isolation Groups = 2 (8 channels per group)
- Output current per channel = 2 A
- Indication of output signals – 1 yellow LED per ch.

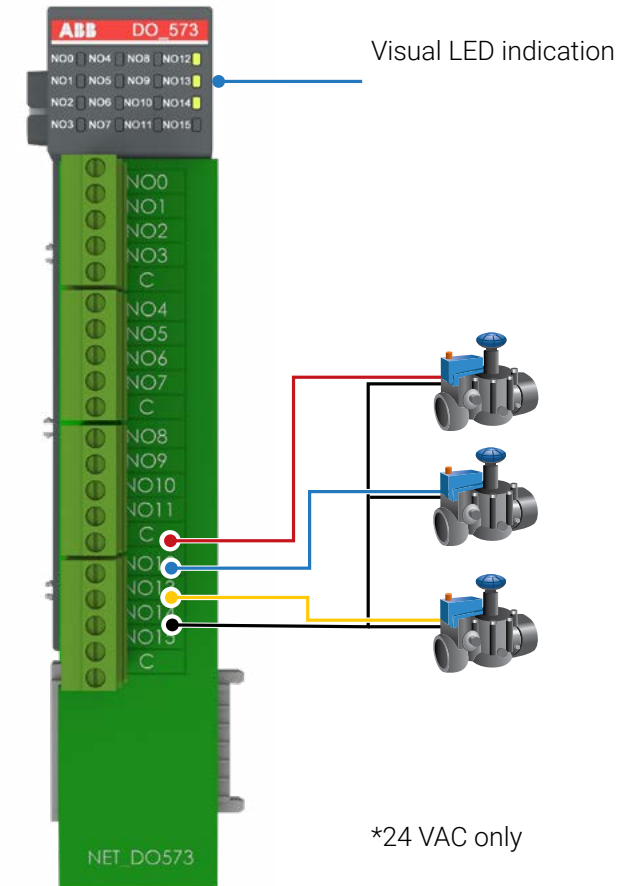

GrowSphere™ MAX - AI561 Module

- 4 Analog Inputs
- Feed (Sourcing) voltage – 24 VDC
- Resolution – 0-20mA; 4 -20mA; 12 bit
- Channel input resistance – 250 ohm

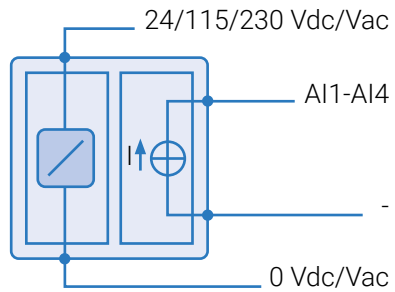

Connecting isolated sensor with current output

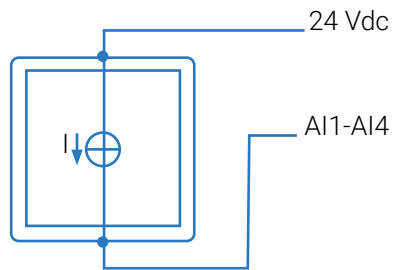

Connecting current transmitter

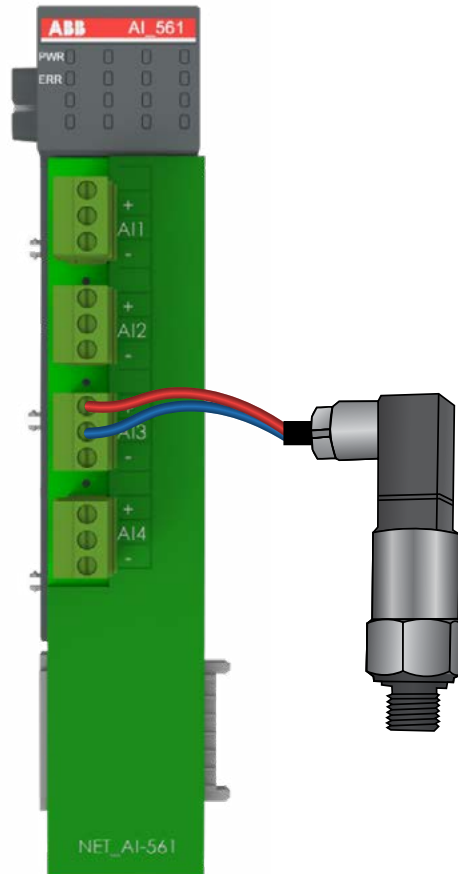

Connect to remote units

Connection of Weather Station – RS232

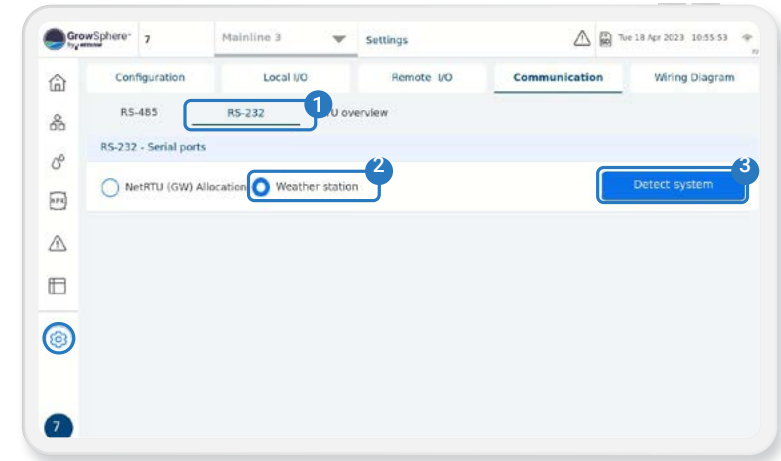

RS232 Module

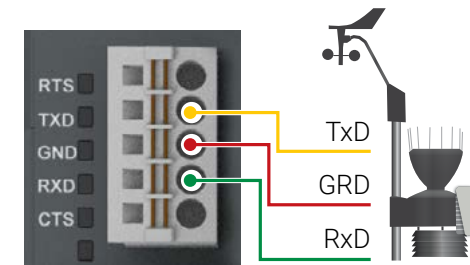

Signal	Description
RTS	Request To Send DCE is ready to accept data from the DTE
TxD	Transmit Data (output)
GRD	Common Ground
RxD	Receive Data (input)
CTS	Clear To Send (input) DCE is ready to accept data from the DTE

State LEDs

Signal	Color	State	Description
TxD	Yellow	ON (blinking)	Transmitting
RxD	Yellow	ON (blinking)	Receiving

Connection of RadioNet / SingleNet – RS485

- Please note: Before starting this process, ensure you have the latest version of PoleNet & Polenet2Max Apps.
- In order to set up the Remote units, kindly get in touch with our Global support team via email at cmt.support@netafim.com

1. From the settings → communication → RS485 screen.
2. Mark the RadioNet allocation.
3. Start allocation.

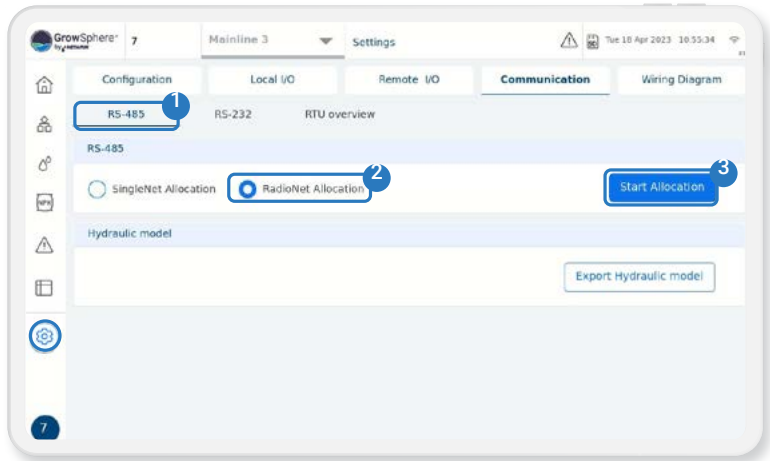

RS485 Module

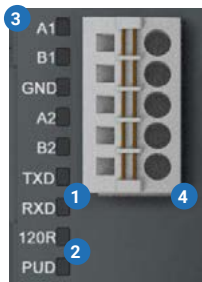

State LEDs

Signal	Color	State	Description
TxD	Yellow	ON (blinking)	Transmitting
RxD	Yellow	ON (blinking)	Receiving
120R	Yellow	ON	Bus termination
PUD	Yellow	ON	Pull-up / Pull-down

1. 2 LEDs for communication state display (TxD and RxD).
2. 2 LEDs for termination state display.
3. Allocation of signal name.
4. 5-pin terminal block for communication interface.

Wiring SingleNet Host & GrowSphere™ MAX



GrowSphere™ Max

SingleNet Host

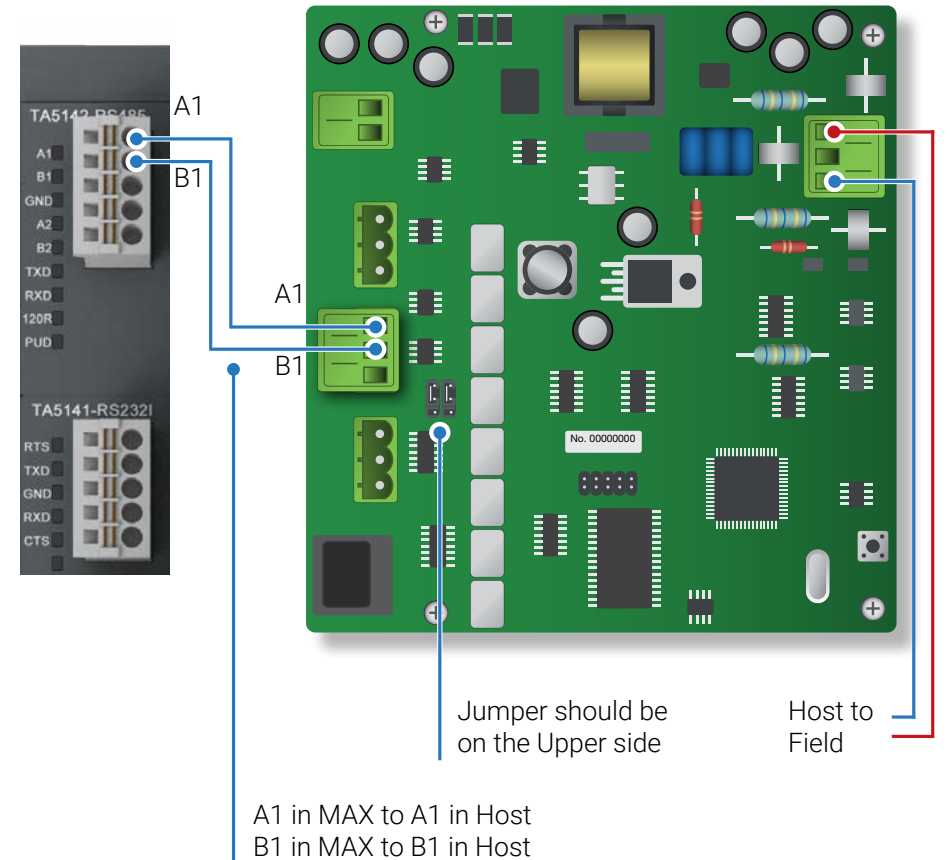

Wiring RadioNet to GrowSphere™ MAX



GrowSphere™ Max

RadioNet Host

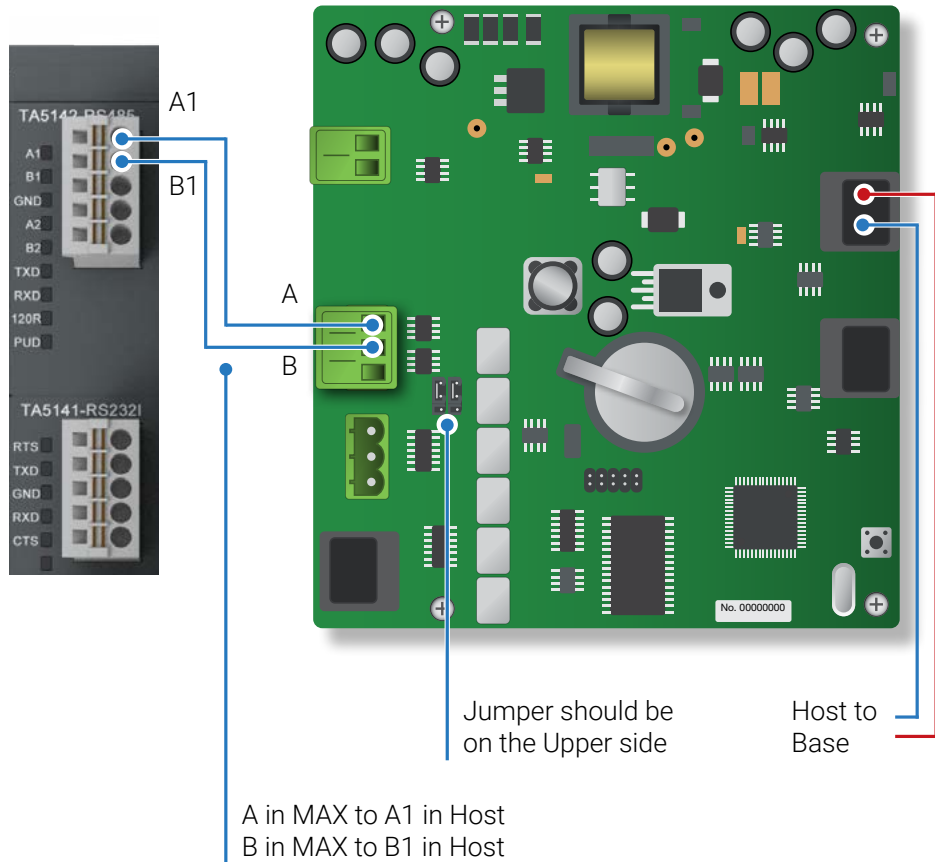

Dosing Setting

Set dosing station configuration

1. Define the numbers of dosing channels and agitators and activate them
2. Select the connected devices that relates to the dosing station

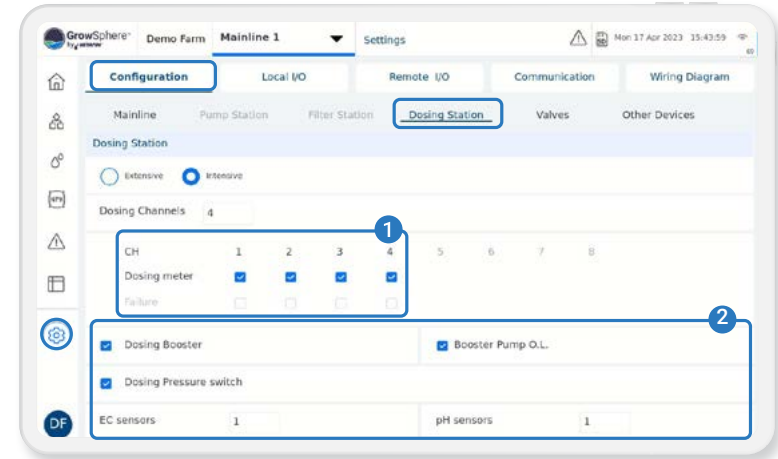

Define analog inputs

1. When you click on Assign, a list of devices that have been allocated will appear.
From there, you can choose the sensor you want to work with and set the input ranges, name, and offset for each sensor
2. To assign additional analog sensors, simply navigate between the pages

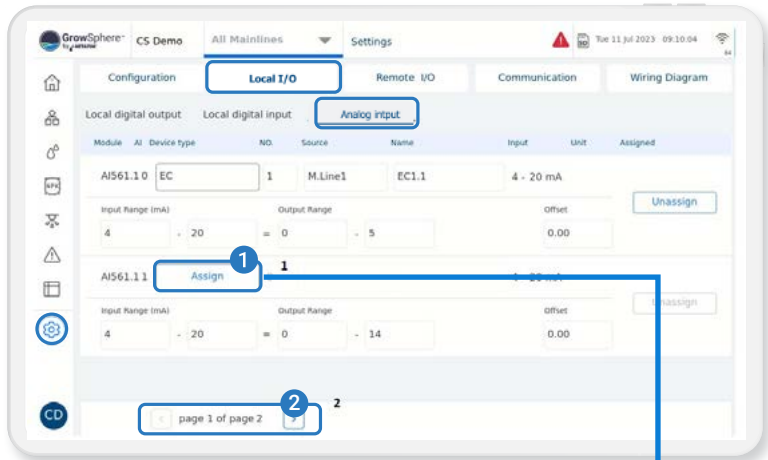

By clicking on Assign, the list below will be opened.
The allocated devices are presented in the list

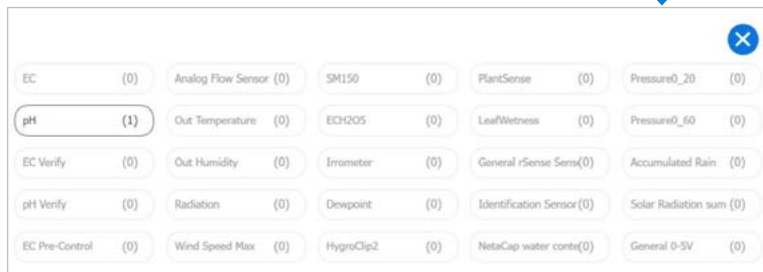

Set Dosing channels

- Activate the connected channels.
- Define the Type, Minimum and Nominal flow, Reaction, DM rate and deviations for each of the channels.

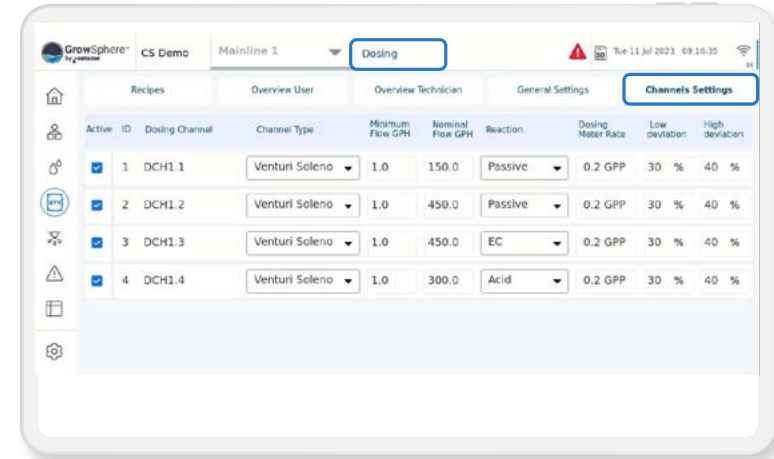

Set EC and pH reaction methods

1. Select Intensive dosing method Extensive can be selected when dosing is controlled by remote units, then EC and pH control are not optional.
2. Activate the relevant reaction method (EC/pH) and set the reactions parameters for each of the sensors

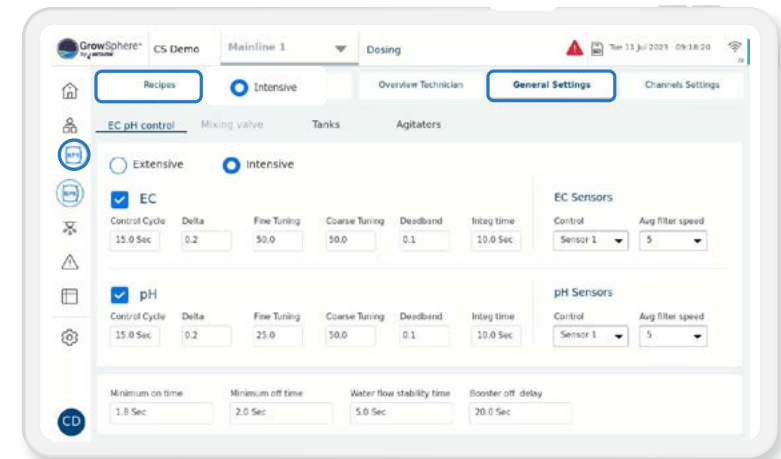

Create new dosing recipe

Click on the Insert new recipe to create a new dosing program. Activate the recipe, and repeat this action for other dosing recipes as required.

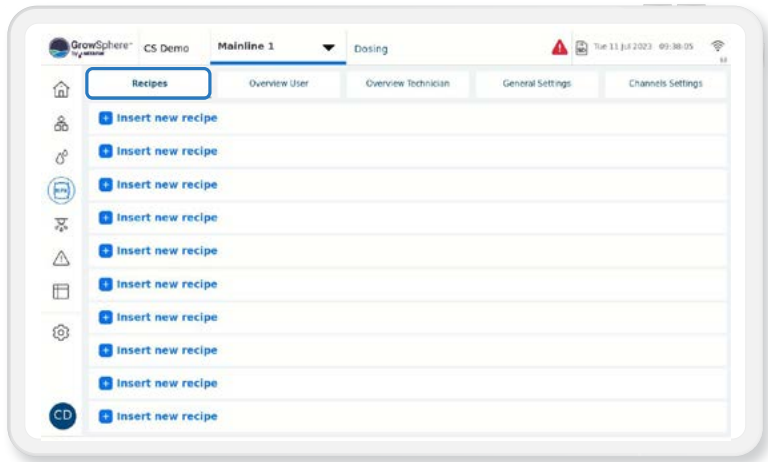

Activate the recipe

Activate the recipe, and repeat this action for other dosing recipes as required.

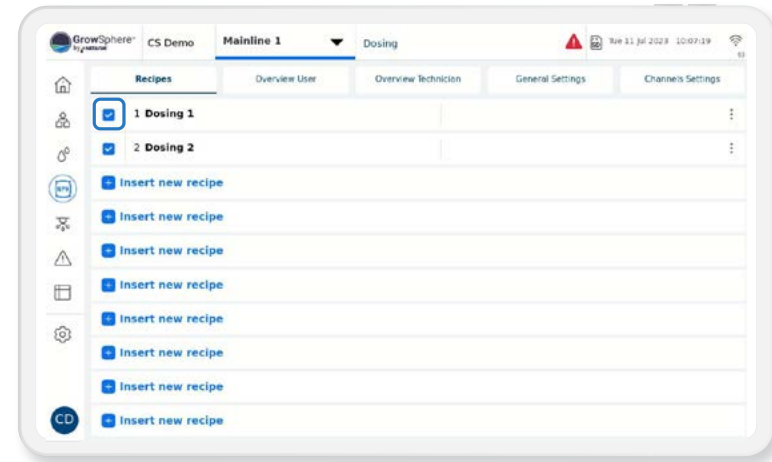

Define the dosing recipe channels

1. Name the recipe
2. Activate the recipe's dosing channels.
3. Select the methods and quantities and the Value for each channel.
DM Control can be activated if required.
4. Set the target EC and pH.

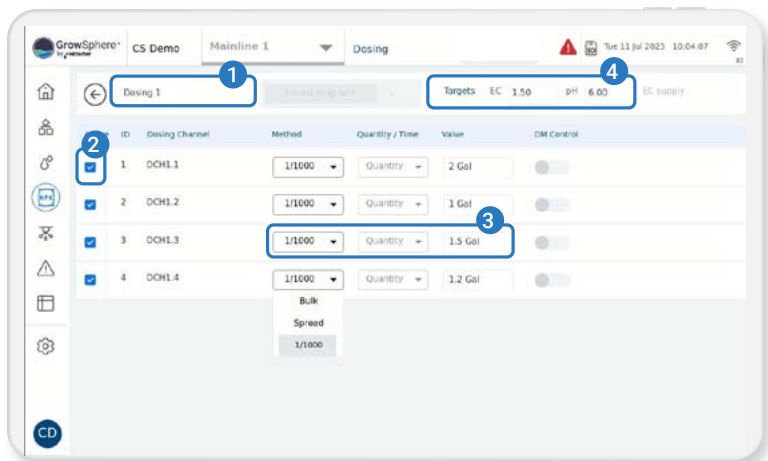

Connection of DO572 Module

- 8 triac outputs – 24 VAC
- 'C' – Shared common
- Output current per channel = 2 A
- 2A Fuse on each channel. Not removable
- Indication of output signals – 1 yellow LED per ch.
- The LED is on when output signal is high

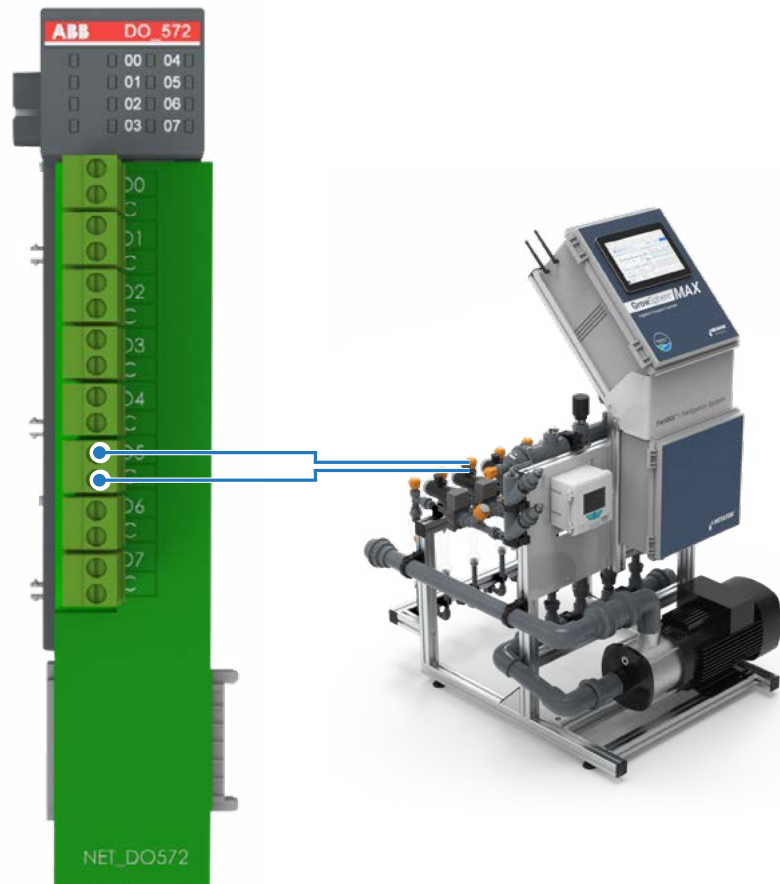

Connection of Analog Inputs Module EC, pH - A1561

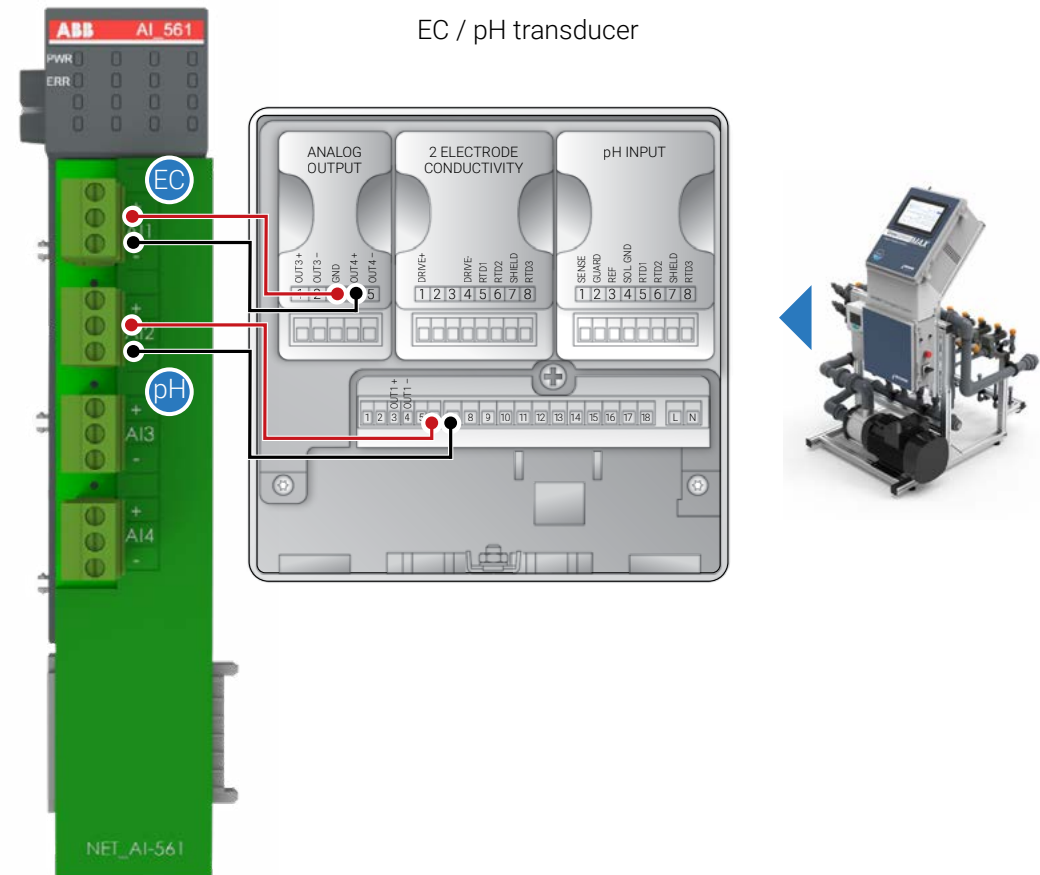

Create irrigation program

Create new irrigation program

Click on Insert new program

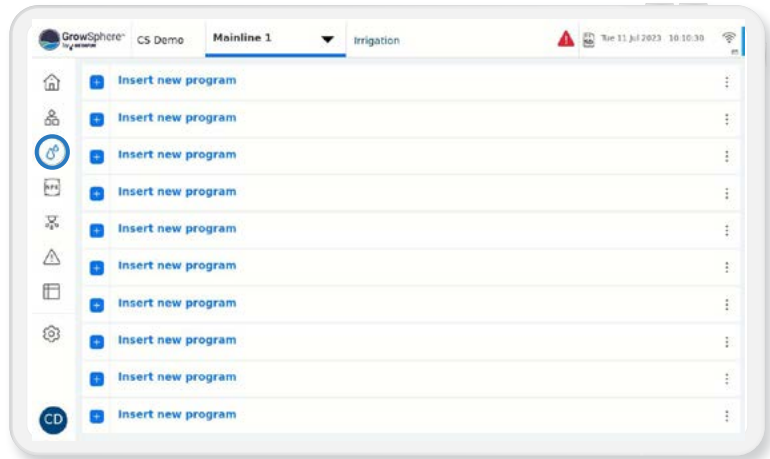

Set irrigation program

1. Name the irrigation program.
2. Specify the type of irrigation program, its priority, and the units to be used.
3. Click on Shifts to create shifts (see next page)
4. Click Dosing to select the Dosing program.
5. Set start times and triggers for irrigation.
6. Choose the days for irrigation and specify whether you want to use water only (indicated by blue) or dosing plus irrigation (indicated by green) for each selected day
7. Provide definitions for water before and after a shift or program.

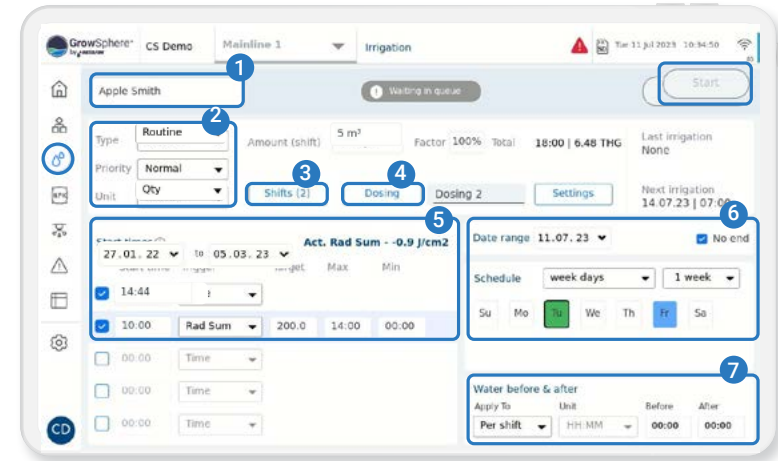

Edit and/or add a new shift

1. Click to add a new Shift
2. Click to edit an existing Shift

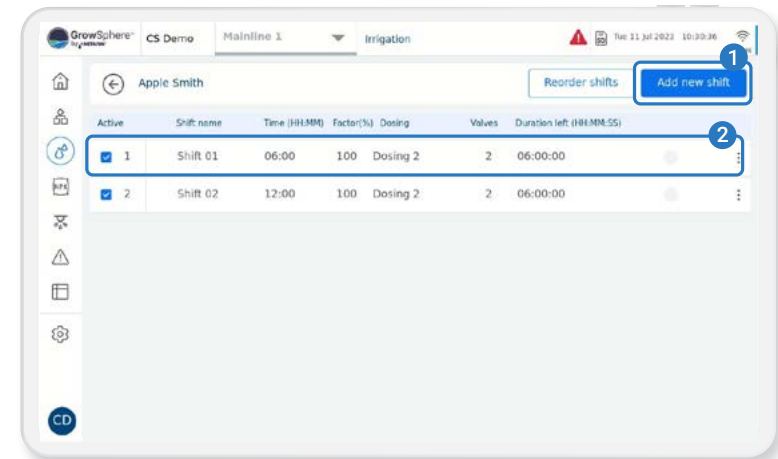

Edit and/or add irrigation shifts

Assign dosing recipe to irrigation program

To assign valves to a shift, follow these three steps:

1. Give the shift a name
2. Choose the valves you want to assign to the shift
3. Assign the shift to a dosing recipe

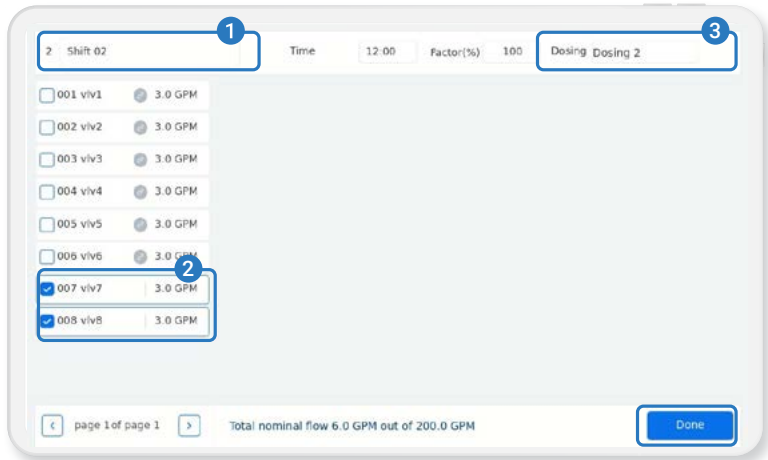

Quick view of your irrigation operation status



Assign dosing recipe to irrigation program

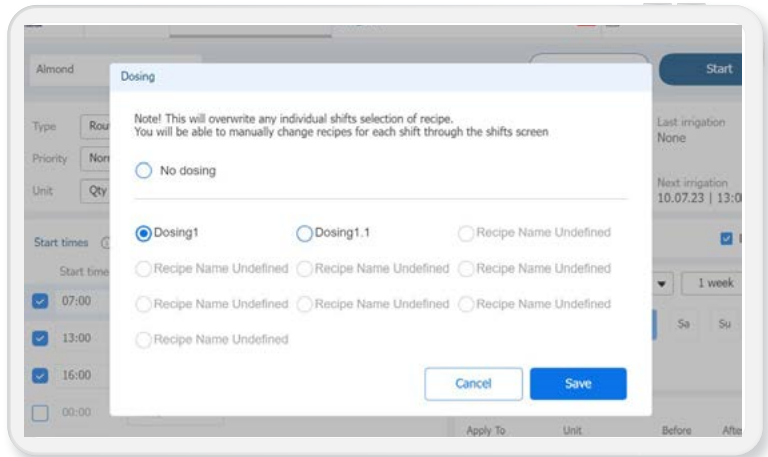



www.netafim.com