

DRIP IRRIGATION HANDBOOK

UNDERSTANDING THE BASICS

© COPYRIGHT 2013, NETAFIM™

NO PART OF THIS PUBLICATION MAY BE REPRODUCED, STORED IN AN AUTOMATED DATA FILE OR MADE PUBLIC IN ANY FORM OR BY ANY MEANS, WHETHER ELECTRONIC, MECHANICAL, BY PHOTOCOPYING, RECORDING OR IN ANY OTHER MANNER WITHOUT PRIOR WRITTEN PERMISSION OF NETAFIM™.

THIS DOCUMENT IS PRESENTED WITH THE EXCLUSIVE AIM OF NOTIFYING SELECTED POTENTIAL CLIENTS REGARDING THE NETAFIM™ DRIP IRRIGATION SYSTEM. RECEIPT OR THE POSSESSION OF THIS DOCUMENT DOES NOT IMPLY RIGHTS AND THE CONTENTS SHOULD BE VIEWED AS A PROPOSAL ONLY. THIS DOCUMENT IS NEITHER ISSUED AS A GUARANTEE, NOR IS IT LEGALLY BINDING.

NETAFIM™ ENDEAVORS TO PROVIDE QUALITY, ACCURATE AND DETAILED INFORMATION. NEVERTHELESS, NETAFIM™ CANNOT ACCEPT ANY RESPONSIBILITY FOR RELIANCE ON THE INFORMATION PROVIDED, AND THE USER IS ADVISED TO INDEPENDENTLY OBTAIN THE PROFESSIONAL ADVICE OF NETAFIM™ AND/OR ITS AUTHORIZED REPRESENTATIVES. THERE IS NO UNDERTAKING BY NETAFIM™ THAT THE PROVIDED INFORMATION OR ANY PART THEREOF IS ACCURATE, COMPLETE OR UP TO DATE.

MENTION OF THIRD-PARTY PRODUCTS IS FOR INFORMATIONAL PURPOSES ONLY AND CONSTITUTES NEITHER AN ENDORSEMENT NOR A RECOMMENDATION. NETAFIM™ DOES NOT ASSUME ANY RESPONSIBILITY WITH RESPECT TO THE USE OR THE PROVISIONS OF SUCH PRODUCTS.

NETAFIM™ WILL NOT ACCEPT RESPONSIBILITY FOR DAMAGE OR LOSS THAT MAY RESULT FROM THE USE OF NETAFIM'S PRODUCTS OR THE USE OF THIS DOCUMENT.

NETAFIM™ RESERVES THE RIGHT TO MAKE CHANGES AND IMPROVEMENTS TO ITS PRODUCTS AND/OR THE ASSOCIATED DOCUMENTATION WITHOUT PRIOR NOTICE.



FOREIGN LANGUAGES

In the event that you are reading this manual in a language other than the English language, you acknowledge and agree that the English language version shall prevail in case of inconsistency or contradiction in interpretation or translation.

CONTENTS

Introduction

Aim of this document	4
Safety instructions	5
Use of symbols in this document	6

Drip irrigation system overview 7

An overview of the drip irrigation system components, their functions and properties:

Structure of a drip irrigation system; Water source; Pumps & pumping stations; Filtration; Main, sub-main, distribution pipes and fittings; Water meters and pressure gauges; Valves; Dosing unit; Dripperlines (laterals); Connectors; End of dripperlines; Sensors; Controller; Accessories and add-ons; Agro-machinery.

Drip irrigation management and operation 47

Guidelines and useful tips for the proper management and operation of a drip irrigation system:

Irrigation; Nutrigation™; Nutrigation™ via a drip irrigation system; Chemigation; Dripperline insertion or laying.

Drip irrigation system maintenance 65

Guidelines and useful tips for the proper maintenance of a drip irrigation system:

Maintenance timetable; System flushing; Preparation and use of a hydraulic conditions checklist; Chemical injection for system maintenance; Water analysis; Sampling drippers; Rodent control; Root intrusion prevention in subsurface drip irrigation (SDI) systems; Contamination from external particles in SDI; Periods of system inactivity.

Water / soil / plant relationship 83

Vital information considering the soil condition, the water characteristics and the needs of the crop, and guidelines for the planning and management of a drip irrigation system:

Soil; Water budgeting; Tensiometers

Appendices

Appendix 1: Unit conversion tables	94
Appendix 2: Further reading	95

INTRODUCTION

Irrigation is the watering of land by artificial methods. Without irrigation, agriculture is limited by the availability and reliability of naturally occurring water from floods or rain.

Drip irrigation is widely accepted as the most efficient irrigation technique as it allows high uniformity of water and nutrient application.

Aim of this document

This document's purpose is to present the basic concepts regarding drip irrigation, to familiarize the reader with the components of a drip irrigation system and their functions, and to provide understanding of the basic operational and maintenance issues regarding the system.

It is intended for Netafim's personnel and its representatives and agents all over the globe, and for its clients, their decision makers, managers and operational personnel.

The importance of thorough knowledge of the subjects discussed in this document for the effective operation and maintenance of the drip irrigation system cannot be overemphasized.

Drip irrigation is the most advanced and the most efficient of all irrigation methods. However, its exceptional capabilities cannot be effectively implemented if the user is not familiar with the related knowledge and does not implement it in the current operation and maintenance of the drip irrigation system.

Netafim™ makes every effort to provide its clients all over the globe with concise, comprehensible documentation with the intent to facilitate the operation and maintenance of the drip irrigation system while maximizing the ensuing benefits - higher yield of superior quality crop with higher market value and shorter ROI.

Netafim's personnel and its representatives and agents all over the globe should make sure to read and understand this entire document thoroughly prior to advising their clients on issues regarding the purchase, installation, operation and maintenance of a Netafim™ drip irrigation system.

It is the responsibility of Netafim's representatives and agents to make sure that, prior to purchase, the client's decision makers are familiar with the installation, operational and maintenance considerations regarding a drip irrigation system, as discussed in this document.

The clients' managers and operational personnel should be familiar with the components of a drip irrigation system and their functions, and study in depth all the operational and maintenance issues discussed in this document prior to first operation of a new Netafim™ drip irrigation system.



ATTENTION

This document is not a user manual. For detailed instructions for the operation, maintenance and troubleshooting of the components of the Netafim™ drip irrigation system, refer to the user manuals and documentation of each component supplied with the system.

This document should be kept available to the farm's personnel at any time for consultation on issues regarding the current operation and maintenance of the drip irrigation system.

In addition, Netafim's irrigation products department is at the client's service for any inquiry, advice or additional information needed after reading this document.

INTRODUCTION

Safety instructions

All local safety regulations must be applied when installing, operating, maintaining and troubleshooting the Netafim™ drip irrigation system and its components.



WARNING

In an agricultural environment - always wear protective footwear.



WARNING

Only authorized electricians are permitted to perform electrical installations!
Electrical installations must comply with the local safety standards and regulations.



WARNING

Measures must be taken to prevent the infiltration of nutrients, acids and chemicals into the water source.



ACID HAZARD

When not handled properly, nutrients, acids and chemicals may cause serious injury or even death. They may also damage the crop, the soil, the environment and the irrigation system.

Proper handling of nutrients, acids and chemicals is the responsibility of the grower.

Always observe the nutrient/acid/chemical manufacturer's instructions and the regulations issued by the relevant local authority.



WARNING

When handling nutrients, acids and chemicals, always use protective equipment, gloves and goggles.



CAUTION

When opening or closing any manual valve, always do so gradually, to prevent damage to the system by water hammer.

INTRODUCTION

The symbols used in this document refer to the following:



WARNING

The following text contains instructions aimed at preventing bodily injury or direct damage to the crops and/or the irrigation system.



CAUTION

The following text contains instructions aimed at preventing unwanted system operation, installation or conditions. Failure to follow these instructions might void the warranty.



ATTENTION

The following text contains instructions aimed at enhancing the efficiency of usage of the instructions in the document.



NOTE

The following text contains instructions aimed at emphasizing a certain aspect of the operation or installation of the system.



ACID HAZARD

The following text contains instructions aimed at preventing bodily injury or direct damage to the crops and/or the irrigation system in the presence of acid.



ELECTRICAL HAZARD

The following text contains instructions aimed at preventing bodily injury or direct damage to the irrigation system components in the presence of electricity.



SAFETY FOOTWEAR

The following text contains instructions aimed at preventing foot injury.



PROTECTIVE EQUIPMENT

The following text contains instructions aimed at preventing damage to health or bodily injury in the presence of nutrients, acid or chemicals.



EXAMPLE

The following text provides an example to clarify the operation of the settings, method of operation or installation.

The values used in the examples are hypothetical. Do not apply these values to your own situation.



TIP

The following text provides clarification, tips or useful information.

DRIP IRRIGATION

SYSTEM

OVERVIEW

Structure of a drip irrigation system	8
Water source	10
Pumps & pumping stations	10
Filtration	14
Main, sub-main, distribution pipes and fittings	20
Water meters and pressure gauges	22
Valves	24
Dosing unit	26
Dripperlines (laterals)	31
Connectors	36
End of dripperlines	37
Sensors	39
Controller	41
Accessories and add-ons	43
Agro-machinery	44

DRIP IRRIGATION SYSTEM OVERVIEW

A drip irrigation system comprises many components, each one of them playing an important part in the operation of the system.

The aim of this chapter is to provide an overview of the drip irrigation system components, their functions and properties.

Structure of the drip irrigation system

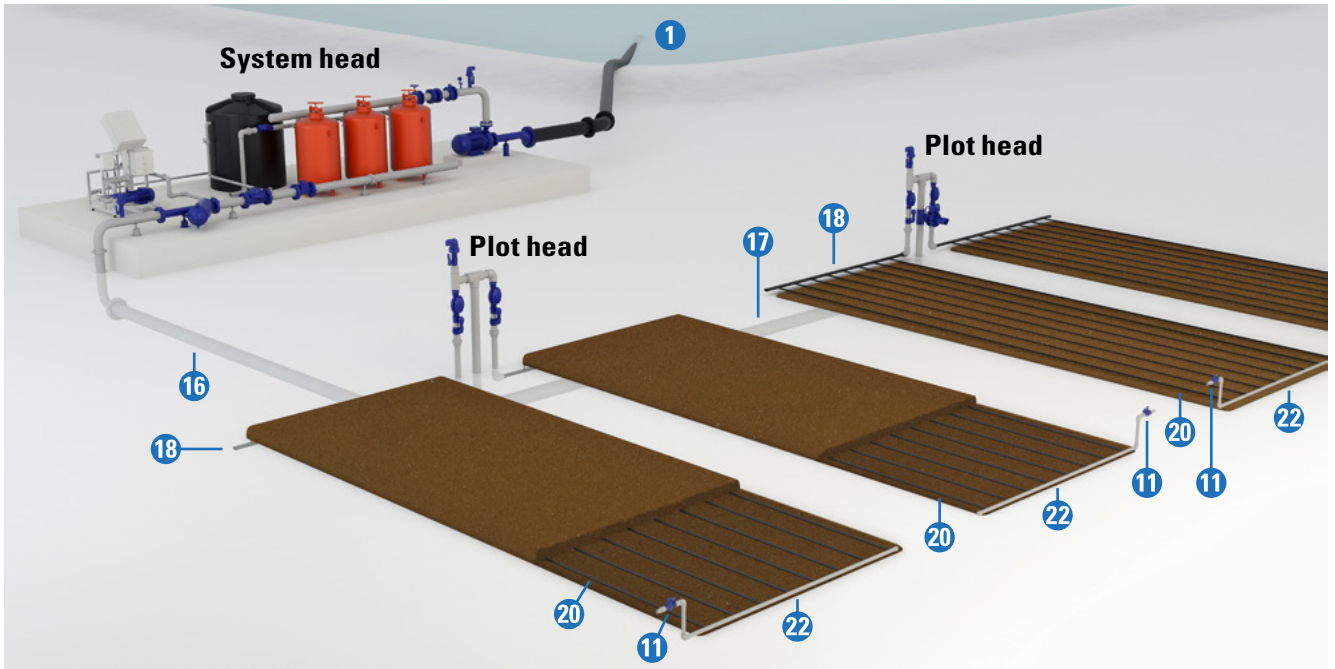

System head

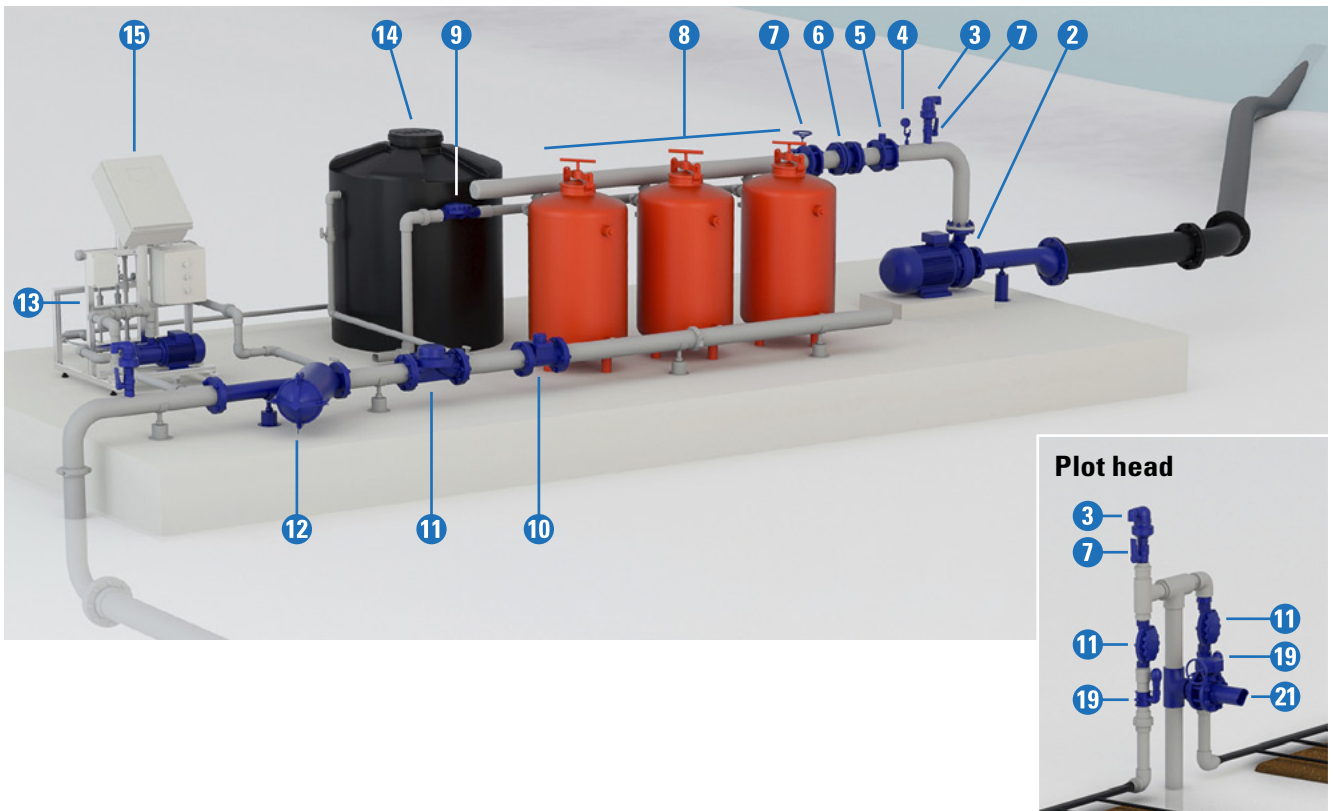

DRIP IRRIGATION SYSTEM OVERVIEW

Schematic diagram

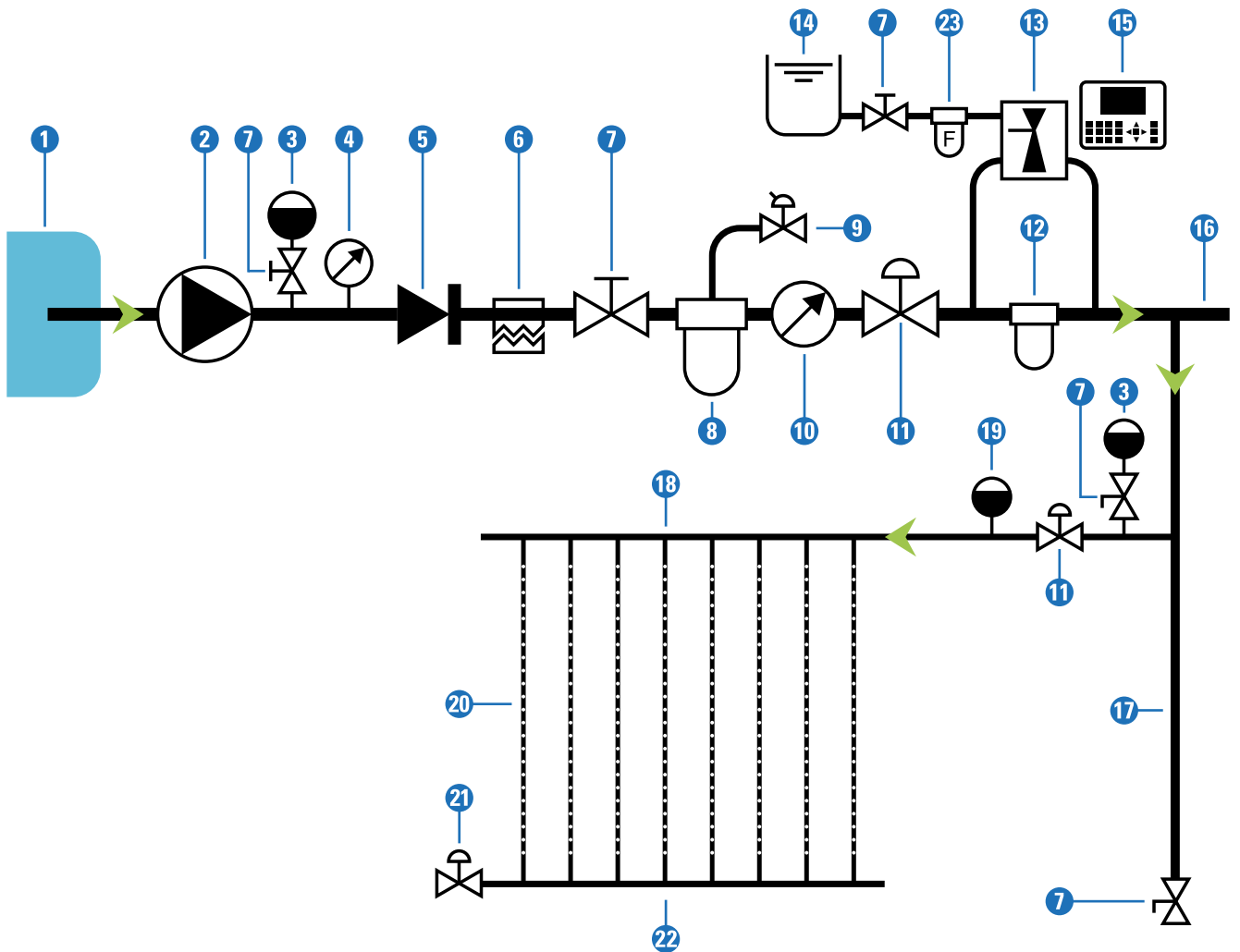

- | | | |
|------------------------|--|-----------------------------------|
| 1 Water source | 9 Main filtration automatic drainage valve | 17 Sub main line |
| 2 Pumping station | 10 Water meter | 18 Distribution line |
| 3 Air valve | 11 Hydraulic valve | 19 Kinetic valve (vacuum breaker) |
| 4 Pressure gauge | 12 Secondary filtration unit | 20 Dripperline |
| 5 Check valve | 13 Dosing unit | 21 Flushing valve |
| 6 Shock absorber | 14 Fertilizer tank | 22 Flushing manifold |
| 7 Manual valve | 15 Irrigation controller | 23 Fertilizer filter |
| 8 Main filtration unit | 16 Main line | |

DRIP IRRIGATION SYSTEM OVERVIEW

Water source

There are basically two main types of water sources: groundwater and surface water:

Many existing and potential water supply sources for irrigation systems are derived from surface water, which does not tend to have high levels of salts (with the exception of some coastal areas), and thus systems are usually less prone to formation of precipitates in drippers when using a surface water source.

Surface water, however, tends to introduce biological hazards. If wastewater is being considered as a source, quality and clogging potential will vary depending upon the extent of treatment.

Groundwater is generally of higher quality than surface water. However, iron and manganese levels should be measured, as high levels may lead to dripper clogging, and treatment may be required.

Pumps & pumping stations

Unless the water at the source is supplied at an adequate flow rate and pressure (by municipal or other entity supply, a pre-existing pump upstream from the irrigation system or gravitational pressure*), a pump will be needed to push water from the source through the pipes and drippers.

Most irrigation systems include pumps as an integral part of the drip irrigation system.

***Gravitational pressure** (also known as hydrostatic pressure) is the pressure at a point in a fluid at rest due to the weight of the fluid above it. If the water source is at a higher elevation than the drippers in the field, the elevation difference between them will determine the gravitational pressure in the system (e.g. the water level in a tank is 5 meters above the elevation of the pump's axis, the gravitational pressure is 5 meters = 0.5 bar = 7.25 PSI).

Selecting a pump for an irrigation system requires an understanding of the water conditions and local system requirements.

Poor pump selection can lead to high operating costs and shortened pump life; this in turn impacts on the performance and reliability of the whole irrigation system.

When a pump site is selected it is necessary to consider a range of factors, including availability of power, proximity to the development site and water quality issues.

Power source for the pump

The power source for the pump will depend on the availability and accessibility of the energy resource in the local area.

In most instances, electricity is preferred because of reduced labor requirements and higher efficiency, resulting in lower energy cost. Three-phase power is usually required to operate over 10 horsepower (hp) irrigation pumps.

If electricity is not available, alternative power sources such as diesel, gasoline, or solar may be used. The most common alternatives are gasoline engines for small pumps and diesel engines for larger pumps.

DRIP IRRIGATION SYSTEM OVERVIEW

Pump types

In most irrigation applications, centrifugal pumps are used.

A centrifugal pump is a rotodynamic pump that adds energy to the water using a rotating impeller. It may be either horizontal-shaft or vertical-shaft (including submersed pumps).

Horizontal pumps are more frequently used to pump water from surface sources such as ponds.

Horizontal-shaft pump

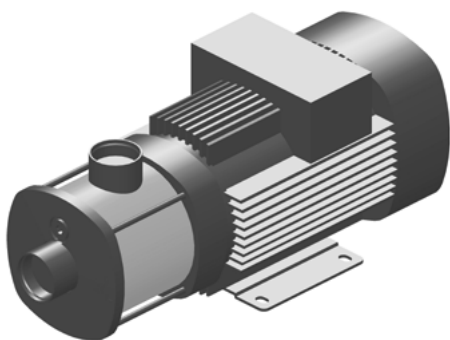

Vertical-shaft pump

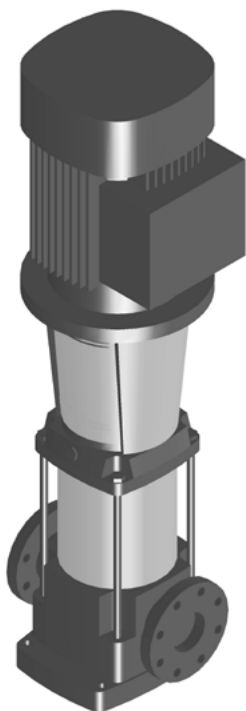

Vertical-shaft submersed pump

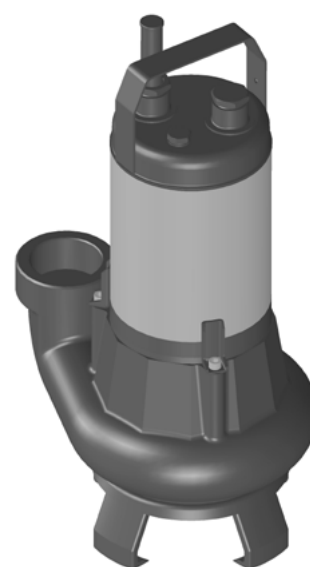

Pump capacity

When selecting a pump, four basic factors must be considered:

- **Pump discharge (flow rate)** defines the quantity of water supplied by the pump during 1 time unit (units: m³/hour, liter/second or gallons/hour).
- **Pressure (pressure head)** defines the internal energy of a fluid due to the pressure exerted on its container's walls (also known as static pressure head or static head) (units: bar or psi. 1 bar = 14.5 psi).
- **Net Positive Suction Head (NPSH)** is the required head value (suction lift) at the inlet of a horizontal pump enabling it to pull water upwards while keeping the water from cavitating* (inherently limited to 0.8 bar net).

***Cavitation** - The formation of vapor cavities ("bubbles" or "voids") in a liquid. It usually occurs when a liquid is subjected to rapid changes of pressure that cause the formation of cavities where the pressure is relatively low. When subjected to higher pressure, the voids implode and can generate an intense shockwave causing significant damage to the pump's impeller and chamber.

- **Friction head** - Head loss caused by the friction between the fluid and the inner walls of the shaft enclosure of a vertical pump (or in the outlet pipe of a vertical submersed pump) which pulls the water upwards. Friction loss increases with run length and by the square of the fluid velocity. It affects the required pressure and flow rate.

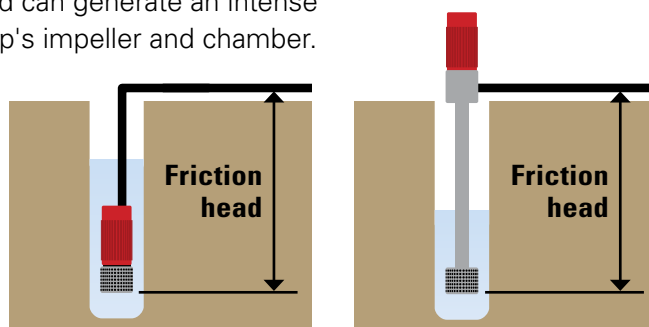
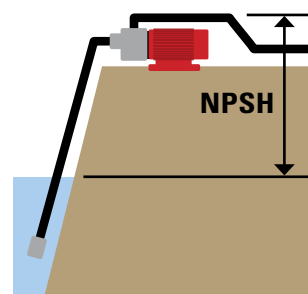

DRIP IRRIGATION SYSTEM OVERVIEW

The output pressure of a pump is dependent on pressure head and flow rate (a higher flow rate causes a lower pressure and vice versa, all other variables being unchanged).

Make sure the pump is able to deliver adequate flow rate and pressure for the application. Obtain a performance curve for the pump and have modifications made if it is not adequate - the energy savings alone will easily pay for any upgrades required, which will also improve system operation and crop production, resulting in a shorter ROI.

Pump selection

The irrigation system design will specify the required pump duty (flow rate and pressure head). The best pump choice is the pump in which the Best Operating Point (BOP) occurs at this flow rate and pressure head and that can operate at the available suction head.



CAUTION

The farther the pump's Operating Point is from the BOP, the higher the operating costs, the lower the efficiency and the shorter the life expectancy of the pump.

Main considerations:

- How the pump is to be installed and what the suction lift will be ([see page 11](#)).
- The performance required in terms of flow rate and pressure head.

Constraints

Pump operating constraints may affect the supply of water and must be considered for effective planning. Common constraints include:

- Energy constraints that do not enable operation of the pump during certain hours of the day.
- Economic constraints that prevent the pump from being operated due to prohibitively high costs of electricity at certain times (days of the week or hours during the day).
- Time constraints where the water source may be unavailable at certain times or days of the week due to the sharing of resources amongst different growers.



NOTE

In order to extend the lifespan of a pump, it should be operated as continuously and evenly as possible (e.g. uninterrupted operation without extreme variations in flow rate).



NOTE

To ensure flow rate stability, the consumption of the individual irrigation shifts should be as equal as possible. wherever possible, It is strongly recommended that the consumption of the smallest shift should not be less than 75% of the consumption of the largest shift.

The pump's performance curve

Each pump must be supplied with its performance curve, as an integral part of the product and the supplier/manufacturer must commit to the data presented in it.

It is very important to keep the pump data documentation available for the whole lifetime of the pump.

The performance curve of the pump (flow rate / pressure range) is indispensable for the design and the construction of the entire irrigation system.

The pump outlet pressure is related to the discharge rate. A change of the flow rate will cause a change in the working pressure. Changes in the flow rate and pressure may be critical, when considering the relationship between the flow rate, the working pressure and the pump's efficiency curve in the planning process.

The steeper the pump's operating curve, the more a change in flow rate will affect the working pressure.

DRIP IRRIGATION SYSTEM OVERVIEW



ATTENTION

Select a pump with as flat an operating curve as possible.



EXAMPLE

Flat operating curve

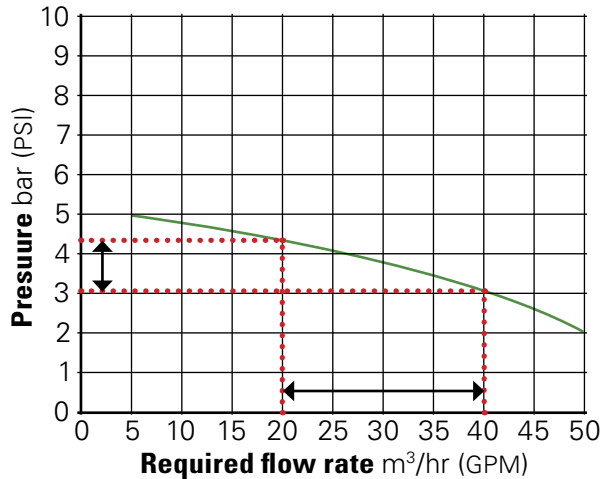

Step operating curve

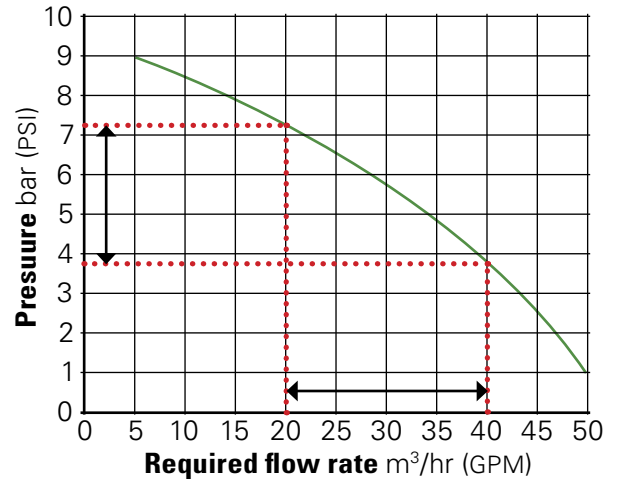

Reconstruction of the pump's performance curve

If the performance curve of the pump is not obtainable, it can be reconstructed as follows:

To measure the pump's discharge rate and pressure, install the following accessories on the pump outlet pipe:

- A water meter
- A pressure gauge
- A manual valve to regulate the water flow

Install the accessories as shown:

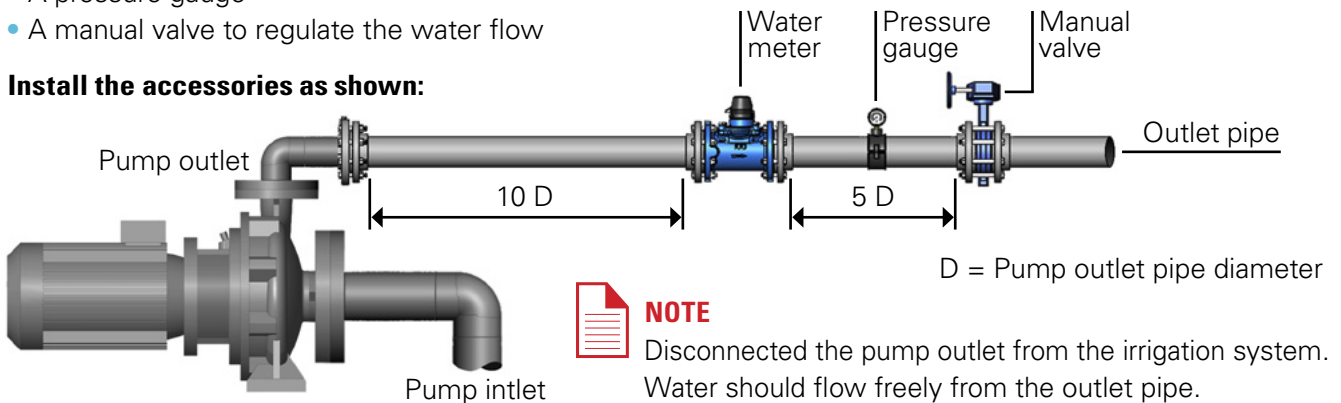

NOTE

Disconnected the pump outlet from the irrigation system. Water should flow freely from the outlet pipe.

Perform the following steps:

- Use a grid where the horizontal axis represents flow rate and the vertical axis represents pressure.
- Turn on the pump.
- Wait a few minutes for the flow to stabilize.
- Fully open the manual valve and mark the point representing the flow rate and pressure on the grid.
- Repeat the action with the manual valve open 3/4, 1/2 and 1/4 turn - in that order.
- Connect the points on the grid with a continual line.

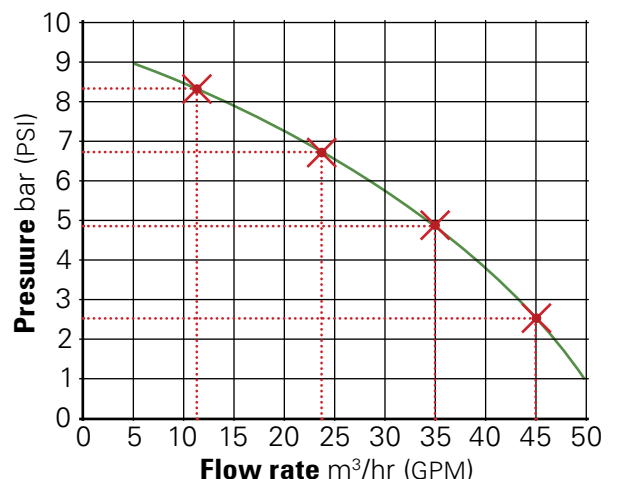

DRIP IRRIGATION SYSTEM OVERVIEW

Filtration

Filtration is critical in any drip irrigation system. Effective filtration is essential for proper irrigation system operation and long-term performance, as it prevents the irrigation water from clogging the drippers.

Water quality

The concept "water quality" relates to the variety and concentration of the dissolved and suspended components in the water.

Water requirements for drip irrigation

The quality of water for irrigation relates to the parameters required to maintain the crop's health and the integrity of the irrigation system. Every type of pressurized irrigation system requires attention to the water quality to avoid clogging of the irrigation components in order to enable orderly long-term irrigation according to the irrigation program.

Water quality will dictate filtration requirements, chemical injection requirements, and management of the irrigation systems to prevent dripper clogging.

Causes of dripper clogging in systems may be chemical (precipitates or scale), physical (grit or particulates such as sand and sediment) or biological (such as algae or bacteria).

The water's chemical characteristics are influenced by the variety and concentration of the substances dissolved in it. These dissolved substances include ions of dissolved salts such as chloride, sodium and nutrients (nitrogen, phosphorous, potassium and others). Calcium and magnesium influence the hardness of the water, iron and manganese are liable to be found either dissolved or as a residue, along with other dissolved organic compounds and even poisonous substances.

The biological characteristics of the water quality include a variety of living organisms such as micro-organisms, including bacteria, viruses, single celled entities, algae and zooplankton, which develop in open water along with creatures developing within the water transport system itself.

The water quality is expressed by the physical conditions and the variety and concentration of its constituents.

The quality of the water is determined by a wide variety of parameters (measured or calculated) affecting the crop, the soil and the irrigation system. Some of them are listed below:

- **EC** (electrical conductivity)
- **pH** (level of acidity or alkalinity)
- **Ca** (calcium - hardness of the water)
- **Mg** (magnesium)
- **Na** (sodium)
- **K** (potassium)
- **HCO₃** (bicarbonate)
- **CO₃** (carbonate)
- **Alk** (alkalinity)
- **Cl** (chloride)
- **SO₄** (sulfate)
- **PO₄** (phosphate)
- **N-NH₄** (nitrogen-ammonium)
- **N-NO₃** (nitrogen-nitrate)
- **B** (boron)
- **Fe** (iron)
- **Mn** (manganese)
- **TSS** (total suspended solids)
- **TDS** (totally dissolved solids)
- **Turbidity**
- **Algae and Chlorophyll**
- **Zooplankton**
- **BOD** (biochemical oxygen demand*)
- **COD** (chemical oxygen demand*)
- **VSS** (volatile suspended solids)

*When waste, industrial effluent and/or recycled waters are used.

DRIP IRRIGATION SYSTEM OVERVIEW

The water quality required for drip irrigation cannot always be defined in terms of particle sizes or the concentration of any specific factor, because of the complexity of the clogging factors and the changes occurring in them as they travel through the irrigation system. Changes such as water temperature, water pressure and flow rate all have an influence on the crystallization of suspended dissolved compounds, their unification and settling.

The most suitable way of defining the required quality of irrigation water is based on knowledge of all the clogging factors and determination of upper permitted threshold value for them in water arriving at the distribution system without fear of clogging or damage to the system.

Water Contamination

For use with a drip irrigation system, irrigation water must be filtered to remove:

- **Physical material** - Silt, clay, mud, etc.
- **Chemicals** - Iron, calcium, manganese (these sometimes combine to form conglomerates), etc.
- **Organic material** - Plankton, etc.
- **Biological material** - Algae, etc.

Common clogging factors in water sources

Water source		Clogging factor (according to prevalence)		
		Physical	Chemical	Biological
Ground	Wells	Sand	Calcium*, Iron, Sulfide, Manganese	Ferric and manganese bacteria, Sulfur bacteria
	Springs	Sand, silt	Calcium*, Iron, Sulfide, Manganese	Protozoa, Bryozoa, Ferric and manganese bacteria, Sulfur bacteria
Surface	Lakes and Reservoirs	Sand, silt, algae, zooplankton	Calcium*, Sulfide, Iron & Manganese**	Protozoa, Bryozoa, Sulfur bacteria
	Rivers	Sand, silt, clay	Calcium*, Iron, Manganese	Protozoa, Bryozoa
	Canals	Sand, silt, clay, algae, zooplankton	Calcium*, Iron and Manganese**	Protozoa, Bryozoa
Reclaimed wastewater	Non-Accumulating ***	Suspended organic material	Sulfide	Protozoa, Bryozoa, Bacterial silt
	Accumulating ****	Algae, zooplankton, suspended organic material	Sulfide	Protozoa, Bryozoa, Bacterial silt

*Depending on the pH and temperature of the water.

**Iron and manganese may appear when the water pH is low.

***Non-accumulating-effluent emerging from a mechanical biological wastewater treatment plant.

****Accumulating-effluent after processing in pools, or sewage from reservoir.

DRIP IRRIGATION SYSTEM OVERVIEW

Definition of water quality and treatment requirements for drip irrigation

Parameter	Concentration			Treatment	
	Low	Medium	High		
Suspended solids (mg/l)	<20	20-60	>60	Filtration*	
Sand (mg/l)	<1	1-5	>5	Hydrocyclone sand separation & filtration*	
Silt & Clay (mg/l)	<20	20-60	>60	Filtration*	
Calcium conc. (as CaCO ₃) (mg/l)	<50	50-300	>300	pH rectification	
Iron (mg/l)	<0.1	0.1-0.5	>0.5	Oxidization & iron removal	
Manganese (mg/l)	<0.02	0.02-0.3	>0.3	Oxidization & manganese removal	
Sulfide (mg/l)	<0.01	0.01-0.2	>0.2	Oxidization & purification	
Algae (Chlorophyll A) (mg/l)	<0.3	0.3-0.8	>0.8	Treatment at water source; Filtration & chlorination	
Plankton (details)	Plankton	<2	2-20	>20	Treatment at water source & filtration
	Copepod	<5	5-50	>50	Treatment at water source & filtration
	Rotifer	<50	50-200	>200	Filtration (low concentration)
	Dissolved oxygen (mg/l)**	<0.5	0.1-0.5	0.1>	Treatment at water source; pumping point (add if higher concentration)
pH	pH rectification to required level according to crop and soil				
Phosphorous (mg/l)	<1	1-10	>10	Treatment at water source (nutrients or sewage)	
Heterotrophic bacteria (bacterial slime)	0	Presence	Colonization	Treatment at water source; purification	
Sulfuric bacteria	0	Presence	Colonization	Sulfide removal & purification	
Iron & Manganese bacteria	0	Presence	Colonization	Iron & manganese removal & purification	
Col. Protozoa	0	Presence	Colonization	Regular purification	
Bryozoa	0	Presence	Colonization	Purification & filtration	
Snails and shells	0	Presence	Colonization	Avoid development	
BOD sewage (mg/l)	<10	10-50	>50	Sewage treatment, filtration & chlorination	

*In extreme cases sedimentation prior to filtration is required.

**Although it does not lead directly to clogging of the drippers, a lack of oxygen in the water usually indicates the presence of sulfide. A lack of oxygen in sewage indicates a poor level of sewage treatment.

Water analysis

A water analysis is necessary in order to select the appropriate type of filtration system, to prescribe a suitable maintenance program, to select the type of dripperlines and to prescribe an appropriate Nutrigation™ plan (see [Water analysis](#), page 77).

DRIP IRRIGATION SYSTEM OVERVIEW

Types of filters

The types of filters used most often in drip irrigation systems are:

Media filters (gravel or sand) are necessary for any surface water source and especially so for wastewater. They consist of a metal or plastic enclosure incorporating small gravel stones or sand, which traps the dirt. This filter includes a flushing system for washing the gravel or sand and returning the dirt to the water source.



ATTENTION

It is highly recommended to install a screen filter downstream the media filter in order to prevent infiltration of filter medium into the system in the event of a malfunction of the media filter.

Disk filters are used with surface water systems, wells or municipal water sources. These filters are comprised of a series of grooved plastic disks stacked together with a total equivalent screen size ranging from 40 to 400 mesh. These filters enable deep three-dimensional filtering (e.g. allow entrapping of more particles as water passes through the pores created by the grooves in the surfaces of the filtering disks stacked together in the filter). Having more surface area than screen filters, disk filters are better suited for higher flow rates.

Screen filters are used mainly as secondary filters with surface water systems or as primary filters with well or municipal water sources. A screen filter is comprised of a cylinder with a net that traps the dirt. This filter is intended for relatively clean water; its use is less common with water from a reservoir or pumped water.



ATTENTION

In any type of filter, the dirt returned to the water source should be discharged as far as possible from the suction point. In a streaming source (e.g. a river) the discharge point should be downstream from the suction point.

Hydrocyclone sand separators are used as a preliminary stage of filtration in the presence of sand or other heavy particles (50 micron or bigger) in the source water. It utilizes centrifugal force to separate the particles from the water. The separated material drops down into a tank or reservoir where it can be removed later. It is not a true filter, since there is no physical barrier to separate out the particles, but it is often used before a filter to first remove the bulk of the contaminant, where the filter does the final cleaning. This type of design reduces the time required to flush and clean the main filter. Each hydrocyclone model has its specific operation flow rate range, it will not perform outside this range.



DRIP IRRIGATION SYSTEM OVERVIEW

Filter screen/disk size

The relevant term for drip irrigation is the size of the gaps between fibers in the filter, in **Micron** (1/1000mm). **Mesh size** represents the number of pores (openings) per linear inch (typically 40-200) but does not represent the size of each pore.

Since the filtration industry traditionally uses mesh size, see the table below for **Micron/Mesh** conversion:

Micron (µm) = size of gaps between fibers	400	250	177	125	105	100	74
Mesh = number of pores per linear inch	40	60	80	120	140	150	200

*The mesh to micron conversion is not a proper mathematical conversion but a commercial approximation.

Considerations for comparison between automatic filters

Consideration	Component	Screen	Gravel/Sand	Disc
Removal efficiency of different suspended particles and general operation	Suspended solids (general)	●	●●●	●●●
	General filter level	●	●●●	●●
	Sand (following hydrocyclone)	●●●	●	●●
	Silt and clay	●	●●●	●●
	Algae (< 40 micron)	●	●●●	●●
	Zooplankton	●●●	●●	●●●
	Iron and manganese (after oxidization)	●●	●●●	●●
	Slime	●●●	●	●●
Technical and hydraulic considerations	Low supply capacity	●	●●	●●●
	Very high supply capacity	●●●	●	●●
	Minimum flushing pressure (bar)	2.2	2.0	1.5
	Quantity and cost of flushing water	●	●●●	●
	Water in flushing cycle	●	●●●	●●
	Capacity required for flushing	●●	●●●	●
	Complexity of system	●●	●●	●●
	Corrosion proof	●●	●	●●●
Operational and maintenance considerations	Operational and maintenance requirements	●	●●●	●
	Frequency of operational failures	●	●●●	●
	Expertise required	●●	●●	●●
	Cost of maintenance	Check and compare		
Financial considerations	Cost of system	Check and compare		
	Cost of accessories (pressure, capacity and non-return valves)	Add to cost of system		
	Cost of m ³ /hr of filtered water	Total cost of supply in m ³ /hr		
	System depreciation	Add to calculation		

DRIP IRRIGATION SYSTEM OVERVIEW

Filtration requirements

The design of a filtration system involves selection of filter type and filter size (capacity) depending on the water source and the amounts of particulate matter, carbonates and iron in the water supply and the kinds (if any) of nutrients and/or chemical stock solutions to be injected.

The type of filtration to be used is carefully selected at the planning stage according to the general quality of the irrigation water, and the presence of various substances in it, with respect to the specific requirements of the irrigation system.



NOTE

If a hydrocyclone sand separator is required, make sure it suits the flow rate range of the planned system.

Water quality and drippers specifications will determine the filtration type, level (effective mesh size) and quantity. Most drip irrigation systems require filtration of 130 micron (120 mesh) or higher (filters may also be specified by the maximum particle size that will pass it - in microns).



NOTE

In general, the biggest filter opening should be one tenth the size of the smallest dripper passageway.



ATTENTION

Standard irrigation filters will NOT remove salt or dissolved solids.



ATTENTION

Always install a filter when setting up a drip irrigation system. Even if potable water is used, a basic screen filter is still required.

A well planned drip irrigation system includes 2 stages of filtration:

Main (Primary) filtration

- Responsible for filtering relatively large particles near the water source.
- Comprised of a media or disk filter.
- A hydrocyclone sand separator should be placed before the main filter in cases where sand or other heavy particles (50 micron or bigger) are present in the source water.

Secondary filtration

- Responsible for filtering relatively small particles remaining after the main filtration stage.
- Two types of filters can be used for secondary filtration:
 - **Screen filter**
 - **Disc filter**

DRIP IRRIGATION SYSTEM OVERVIEW

Main, sub-main, distribution pipes and fittings

Main, sub-main, distribution pipes

Pipelines carry water through the entire irrigation system, from the pump through the filters, the valves, and onward to the drippers.



ATTENTION

All pipelines and fittings should be properly sized to withstand maximum operating pressures and convey water without excessive pressure loss or gain.

PVC piping may be used throughout the system or combined with steel piping at the pump station. PVC, polyethylene (PE) or flexible pipes (PolyNet™/FlatNet™) are used for sub-mains and distribution pipes.



ATTENTION

Be sure to consider the expansion and contraction that occurs under normal on-surface operating conditions (each type of pipe is affected to a different degree).



ATTENTION

Pipelines are connected to one another with welds, glue or friction fittings, according to the type of piping in use, and are anchored to the infrastructure supporting them. Make sure all pipelines are properly secured and anchored.



NOTE

In a subsurface drip irrigation (SDI) system, the pipeline is more difficult to access and repair. Making sure all fittings are secure at installation can save significant repair issues later. Particular attention is required especially after the initial growth stage of the crop.

In irrigation design, pipe sizes are specified based on economic, friction loss, water hammer considerations and flushing concerns. As pipe size increases, friction loss decreases (reduced pumping cost) but initial cost increases.



NOTE

In most cases the distribution pipe is installed below the elevation of the dripperlines so that solids will tend to collect in it rather than in the dripperlines.

Irregular field shapes are common due to topography and property boundaries. At the planning stage, care is taken to properly size sub-main and distribution lines where field shape varies. Sub-main and distribution lines for irregularly shaped fields are designed based on actual flow rates of the dripperlines and not on an "average" flow rate of the system.



NOTE

The piping system must be designed not only to allow the flow rate necessary for normal irrigation but also to allow sufficient flow rate for proper flushing velocities in the system (recommended minimum: 0.3 meter/sec; 1 foot/sec). For flushing instructions see [Flushing the main, sub-main and distribution lines](#), page 73).

Design objectives for flushing may result in different pipe diameters being selected than those selected in the design process for normal operation. This is because the flushing flow rate required for achieving a desired flushing velocity in any section of a main, sub-main or distribution pipe may be different than the design flow rate for regular operation.

DRIP IRRIGATION SYSTEM OVERVIEW

Structure of the cross section of a pipe

- The Outside Diameter (OD) of the pipe is the distance between the outside walls of the pipe, measured perpendicularly to the pipe's axis.
- The Inside Diameter (ID) of the pipe is the distance between the internal walls of the pipe, measured perpendicularly to the pipe's axis.
- Wall Thickness (WT)

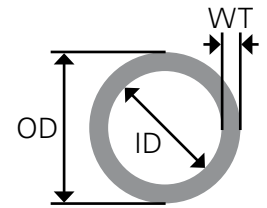

$$\text{Pipe's Inside Diameter} = \text{ID} = \text{OD} - (2 * \text{WT})$$

$$\text{Pipe's Wall Thickness} = \text{WT} = \frac{\text{OD} - \text{ID}}{2}$$



NOTE

The relevant pipe diameter or calculations regarding flow rate and velocity in a pipe is the Inside Diameter (ID).



EXAMPLE

A selection of polyethylene (PE) pipes demonstrating the relation of the pipe's Inside Diameter (ID) to the Outside Diameter (OD):

Pipe diameter/class*	Outside Diameter (OD) (mm)	Wall Thickness (WT) (mm)	Inside Diameter (ID) (mm)
63/12	63	4.70	53.60
75/12	75	5.60	63.80
90/12	90	6.70	76.60
110/12	110	8.10	93.80
125/12	125	9.20	106.60
140/12	140	10.30	119.40
160/12	160	11.80	136.40
200/12	200	14.70	170.60
225/12	225	16.60	191.80
250/12	250	18.40	213.20

*By international standard ISO 4427/07.

For more info, see Polyethylene Rigid and Flexible Pipes - Product Catalog at <http://www.netafim.com/irrigation-products-technical-materials>.

Fittings

A wide variety of fittings are available to fit any drip irrigation system and any type of pipes used.

The selection of fittings is a planning issue defined by the project's BOM (Bill of Material).

For more info see Fittings & Accessories Product Catalog at

<http://www.netafim.com/irrigation-products-technical-materials>.

DRIP IRRIGATION SYSTEM OVERVIEW

Water meters and pressure gauges

Make sure your system has a water meter and pressure gauges in working order! Although simple, these gauges are often overlooked or not maintained. These monitoring devices are essential to proper system operation. System flow rate helps detect leaks or clogging, and must be known to determine the application rate for irrigation scheduling purposes. System pressure also helps detect leaks or clogging, and is essential for managing filters, chemical injectors and the whole system within its operating range.

Water meters

Water meters provide information regarding water application that is essential for irrigation scheduling, and for the monitoring of dripper clogging. Propeller meters are the most common type in agricultural applications.



NOTE

All types of water meters require regular maintenance. Follow the manufacturer's recommendations for required maintenance.

A water meter installed at the head of a drip irrigation system or small water meters placed at the head of selected dripperlines can help in detection of dripper clogging.

A single, large water meter at the head of the drip irrigation system monitors the flow rate to the entire system. Most water meters incorporate a totalizing register that records the total flow (m³, gallons) passing through the meter. Some meters also have an instantaneous flow rate indicator (measured in m³/hr, GPM).

Make sure that the pipe in which the water meter is installed is flowing full (the water flowing fills the entire cross section of the pipe without air pockets) and that there is not excessive turbulence in the pipe. A water meter installed close to a valve, elbow, or tee (T) may not provide accurate information. If the meter has an instantaneous (e.g. m³/hr, GPM) indicator, an excessive fluctuation of the indicator needle is a sign of excessive turbulence in the meter.

To detect clogging or leaks in the irrigation system, check the flow rate in the system weekly (see [Preparation and Use of a Hydraulic Conditions Checklist](#), page 75). A decrease in flow rate over time may indicate clogging. Before checking the flow rate, check that the pressure in the system is as planned. For accurate and useful data about the drip irrigation system to be acquired, the operating pressure of the system must be as initially planned each time the flow rate is checked. If the operating pressure is allowed to vary, the acquired flow rates will be valid but will not be usefully compared for the purpose of clogging detection.

Using a number of small water meters (throat size 5/8" or 3/4") to monitor flow rate to individual dripperlines (laterals) provides greater sensitivity to clogging than does a single, large water meter at the head of the system. Especially recommended in large projects - over 100 Ha (250 acres).

Most small water meters have only a totalizing register, so you will need to keep track of the system operating time between water meter readings (if installed, a controller does it automatically (see [Controller](#), page 41). As with the large water meter, for acquired data to be valid the operating pressure needs to stay constant over time.

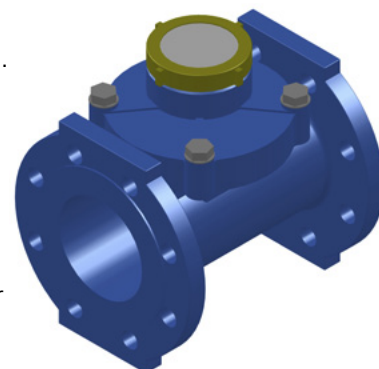

DRIP IRRIGATION SYSTEM OVERVIEW

Pressure gauges

Pressure gauges are essential components in a drip irrigation system. Providing vital information concerning the irrigation system, they help in the detection of leaks and clogging and in the management of filters, chemical injectors and in keeping the system in its operating range.

To acquire as accurate as possible data always use a pressure gauge with a scale representing the pressure range of the system. The typical pressure in the system should be roughly at the midpoint of the gauge's scale.



Pressure loss across a filter

To avoid inaccuracies in the reading of the pressure loss across a filter, use a single pressure gauge connected to a three-way selector valve, as shown.



ATTENTION

Reading the pressure loss across a filter with two different pressure gauges installed at the inlet and at the outlet of the filter might result in inaccurate reading due to calibration difference between the two gauges.

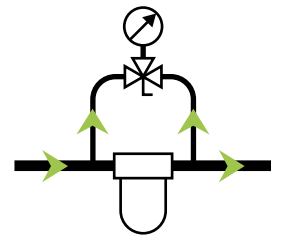

It is important to measure the pressure at a variety of key points along the irrigation system: at the head of the system, at the head of each irrigation zone and at the inlet and end of selected dripperlines in the field.



TIP

Netafim™ offers a variety of nozzle adapters to be connected at the key points in the system, enabling the use of a single hand-held pressure gauge equipped with an insertion needle.

Pressure gauge nozzle adapters

With barb connector for use with PE pipes (i.e. dripperlines).



With thread connector for use with PVC pipes.



DRIP IRRIGATION SYSTEM OVERVIEW

Valves

In an irrigation system, water flow rate and pressure throughout the system should be precisely controlled to ensure efficient and timely water application; therefore proper selection and placement of valves is critical.

Valves play key roles in controlling pressure, flow and distribution under different conditions to optimize performance, facilitate management, and reduce maintenance requirements.



ATTENTION

Valve sizes, maximum working pressure and valve materials should be selected properly to meet the system demands. Oversized valves may not open or close properly while undersized valves may restrict flow and cause excessive pressure loss.

Valves used in a drip irrigation system include:

Manual control valve

4 common types of manual control valves are used in drip irrigation systems:

Ball valve

The ball valve is a quarter-turn valve. In a ball valve the closing mechanism is a sphere (ball) with a port through the middle, connected to a lever in line with it that shows the valve's position. Rotating the lever turns the ball so that when the port is in line with the pipe, flow will occur, and when perpendicular to the pipe, flow is blocked. Designed to be fully opened or closed and is not suitable for regulating the flow.



Butterfly valve

The butterfly valve is a quarter-turn valve. Operation is similar to that of a ball valve. The closing mechanism takes the form of a disk positioned in the center of the pipe. A rod connected to the lever passes through the middle of the disc. Rotating the lever turns the disc either parallel or perpendicular to the flow. Unlike a ball valve, the disc is always present within the flow; therefore a slight pressure drop is always induced in the flow, regardless of valve position. Designed to be fully opened or closed and is not suitable for regulating the flow.

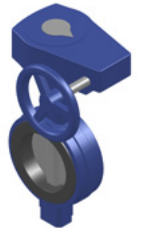

Gate valve

The gate (sluice) valve opens by lifting a gate (wedge) out of the path of the fluid. When the gate valve is fully open, there is no obstruction in the flow path, resulting in very low friction loss. Designed to be fully opened or closed and is not suitable for regulating the flow.



Globe valve

A globe valve is the only type of manual valve recommended for regulating the flow with minimum friction loss. It consists of a movable disk plug aligned with a fixed ring located in the stream. Operated by screw action using a handwheel.



Check valve (One-way valve)

The function of the check valve is to prevent water flow in the opposite direction to that desired.

It serves various purposes:

- Installed at the outlet of a pump that pumps water to a field at a higher elevation - protects the pump from the back wave of water hammer.
- Installed at the outlet of a filter, which conveys water to a higher field - prevents water from flowing back through the system's head components.
- Installed upstream from a dosing unit - prevents fertilizers and chemicals infiltration of the water source.
- Installed on the inlet pipe of a pump, as a foot valve, enables priming of the inlet pipe.



DRIP IRRIGATION SYSTEM OVERVIEW

Hydraulically operated, diaphragm-actuated control valves

Serve different purposes according to the layout of the valve's control loop.

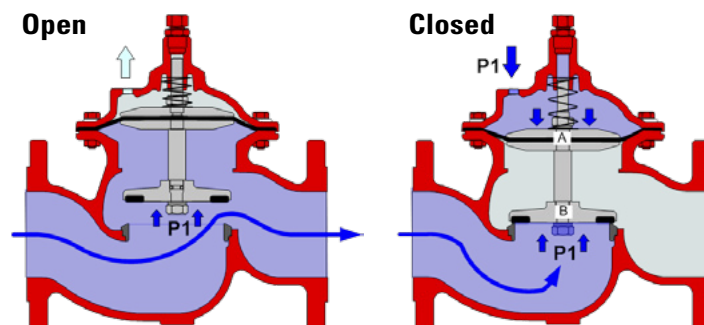

Hydraulic control valve

Opens and shuts off in response to a local or remote pressure command.

Pressure Reducing Valve (PRV)

Reduces higher upstream pressure to lower constant downstream pressure regardless of fluctuating demand, and opens fully upon line pressure drop.

For optimal operation the pressure ratio across a PRV should not be higher than 1:4.

Pressure relief/sustaining valve

Can fulfill either of two separate functions:

- When installed in-line, it sustains minimum preset upstream pressure regardless of fluctuating flow or varying downstream pressure.
- When installed as a circulation valve, it relieves line pressure in excess of preset.

Pressure reducing and sustaining valve

Fulfills two independent functions at the same time:

It sustains minimum preset upstream pressure regardless of fluctuating flow or varying downstream pressure and it prevents downstream pressure from rising above maximum preset, regardless of fluctuating flow or excessive upstream pressure.

Pressure relief valve

Relieves excessive line pressure when it rises above the preset maximum. It responds to a rise in system pressure immediately, accurately and with high repeatability, by opening fully.

Booster pump control valve

A double chambered, active check valve that opens fully or shuts off in response to electric signals. It isolates the pump from the system during pump starting and stopping, to prevent pipeline surges.

Surge anticipating valve

An off-line valve, sensing line pressure. It opens in response to the pressure drop associated with abrupt pump stoppage. The pre-opened valve dissipates the returning high pressure wave, eliminating the surge. The valve also relieves excessive system pressure.

Air valves

Combination air release valve

Evacuates large volume of air during pipeline filling and network draining and allows efficient release of air pockets from pressurized pipelines.



Kinetic air valve

Evacuates large volume of air during pipeline filling and network draining.



DRIP IRRIGATION SYSTEM OVERVIEW

Dosing unit

A dosing unit serves Nutrigation™ and chemigation:

Nutrigation™

The most effective way to increase the yield and quality of a crop is by feeding the plant according to its specific, ever-changing needs. This means delivering the right amount of water and nutrient at the right time. Nutrigation™ refers to injection of nutrients for the plant.

Nutrigation™ is comprised of three stages:

- Dissolving soluble fertilizers (if required).
- Injecting nutrients according to the desired dosing ratios.
- Delivering the precise quantity of nutrients to the plant's root zone.

Chemigation

Chemigation refers to injection of chemicals to prevent or reduce dripper clogging (addition of chlorine, hydrogen-peroxide, acid or others), and the injection of chemicals for crop and soil concerns (herbicides, pesticides and others).

Because the water passages in drippers are relatively small, they can be clogged; therefore, along with filtration, the capability to inject chemicals for dripper clogging control is an important feature.

Benefits of Nutrigation™ and/or chemigation:

- Uniform and timely application of nutrients and chemicals
- Reduced soil compaction due to reduced traffic in fields
- Reduced labor requirements, reduced exposure to chemicals
- Reduced environmental contamination.

The design of a chemical injection system involves the selection of injector type and capacity. If the injection system is to be used for Nutrigation™, the injection unit is sized for this use since injection rates for nutrients are usually much higher than injection rates for chemicals such as liquid chlorine or acid.

Any components coming in contact with nutrients, chlorine, or acid should be resistant to corrosion. Some countries require specific types of injectors for agrochemicals. Always follow local laws and chemical labeling requirements.

Nutrients and chemicals may be injected into pressurized drip systems via a variety of methods:

Netafim™ offers a comprehensive array of dosing systems to ensure precise nutrient delivery for any crop, plot size and application.

Relevant terms:

- **Single dosing channel** - for injection of only one type of fertilizer solution at the same time.
- **Multiple dosing channels** - for injection of several fertilizer solutions at the same time or of a single fertilizer solution at a higher rate.
- **Bulk/Quantitative Nutrigation™** - The entire amount of fertilizers is injected in one shot.
- **Proportional Nutrigation™** - The fertilizers are injected at a constant ratio relative to the flow of irrigation water in the main line.
- **Nutrigation™ based on EC and pH control** - Nutrigation™ is constantly adjusted in order to keep a steady EC and pH level according to the plant's needs.
Can be conveniently accomplished with a controller (Netaflex™, NetaJet™ or FertiKit™) on the dosing system and EC and pH sensors on the dosing unit.

DRIP IRRIGATION SYSTEM OVERVIEW

Fertilizer tank

A fertilizer tank mixes water with fertilizer for quantitative Nutrigation™. It is operated by the hydraulic pressure in the irrigation system and does not need an external energy source (subject to excess pressure available in the system). The desired amount of fertilizer placed in the tank is dissolved and injected into the irrigation system.

Can be connected to the irrigation system in two ways:

- **Inline** - installed directly on the main line (typical of very low capacity systems).
- **Bypass** - installed as a bypass from the main line, a manual or hydraulic pressure reducing valve (PRV), installed on the main line, produces the required pressure differential to operate the fertilizer tank (typical of high capacity systems).

Fertilizer tanks are simple to use and maintain.

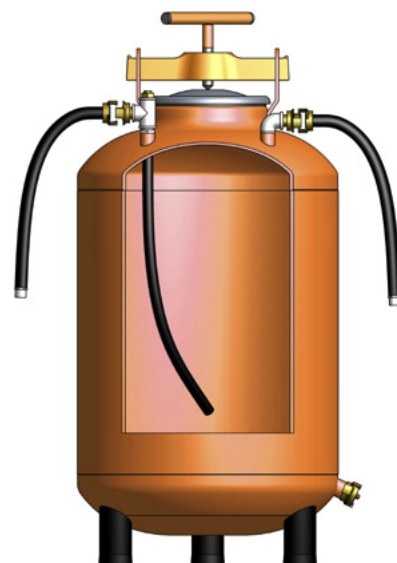

Hydraulic piston motor injector

Its linear hydraulic piston motor is powered by the hydraulic pressure in the irrigation system, and does not require any other energy source for injecting fertilizer into the pressurized irrigation line.

Water enters the injector through the upstream inlet and exits it to the drain line through the water outlet. The fertilizer is injected at twice the pressure of the irrigation line, generated by the hydraulic piston motor itself.

The liquid fertilizer enters the injector through the suction port positioned inside the fertilizer tank and is injected through the injection outlet, downstream, into the irrigation line.

The water consumption of the hydraulic motor is 3 times the quantity of the chemical injected and it can produce an injection flow rate of up to 320 liter/hour (1.4 GPM), depending on the inlet pressure and the pump model.

Can be operated manually or automatically by an irrigation controller.



Netafim™ Venturi Injector - up to 2"

A Venturi injector uses excess pressure in the irrigation system to create a low pressure zone, or vacuum, in the injector throat. This vacuum efficiently draws chemicals into the pressurized water line, eliminating the need for a separate chemical injection pump.

Venturi injectors are the most cost-effective method of introducing chemicals into a pressurized irrigation system, popular because of their simplicity, reliability and low cost, and because they don't require a power source.

Can be easily connected to the irrigation system in two ways:

- **Inline** - installed directly on the main line (typical of very low capacity systems).
- **Bypass** - installed as a bypass from the main line, a manual or hydraulic pressure reducing valve (PRV), installed on the main line, produces the required pressure differential to operate the Venturi injector (typical of high capacity systems).

Venturi injectors include no moving parts and require little maintenance.

They supply an extremely uniform injection rate from start to finish at nominal system flows rates.

Chemical injection capacity: 30 - 1200 l/hr (8 - 320 GPH) depending on injector size and operating pressure.

Can be operated manually or automatically by an irrigation controller.

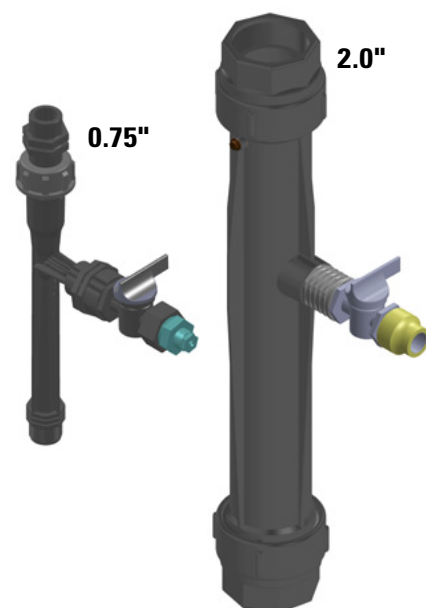

DRIP IRRIGATION SYSTEM OVERVIEW

Electric dosing pump

Intended for flow rates up to 25 l/hr (6.6 GPH), the electric pump is usually used for injection of chemicals and acids for system maintenance.

Maximum pressure: 10 bar (145 PSI).

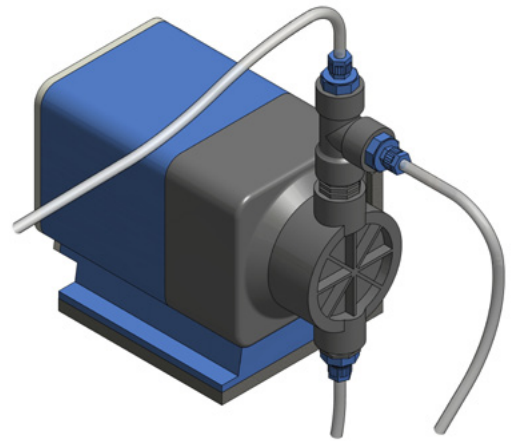

Hydraulic fertilizer injector (proportional)

Applies fertilizers and chemicals proportionally to the water flow through an irrigation system in the slow and constant quantities required for steady growth.

Widely used in open fields, orchards and landscaping to inject an additive into a water line at a consistent injection rate under varying water pressure and flow rates.

This process, injecting additives using only water power, is accurate and simple.

- Water driven, non-electric
- Piston driven by water flow
- Solution is added in proportion to water flow for accurate mixing
- Solution is constantly added as water flows through the unit
- Ratio of additive remains constant



Single channel Mini FertiKit

Venturi injector with booster. This method is used when the pressure differential in the main line is not sufficient to activate a basic Venturi dosing unit. The booster pump creates additional pressure to activate the Venturi while preventing head loss to the system. Supplied with selected size of Venturi (up to 3/4").

A check valve should be installed upstream from the bypass.

Can be operated manually or automatically by an irrigation controller.

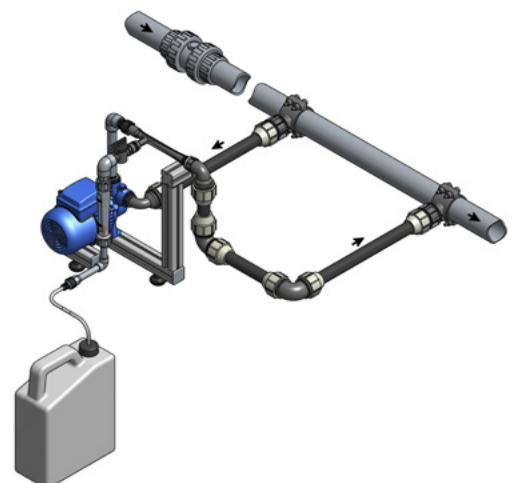

DRIP IRRIGATION SYSTEM OVERVIEW

FertiKit3G™

The FertiKit3G™ is a highly versatile and precise dosing system suitable for an unrivaled range of irrigation system capacities. Covers all applications ranging from open fields to intensive horticulture. Requiring a minimal investment, the FertiKit3G™, a CE-compliant modular system, is the industry's most cost-effective dosing system, whether used for small or large-scale applications.

- **Flexible:** Works with a very wide range of dosing channel flow rates up to 6 units of 50 to 1000 l/hr.
- **Scalable:** For systems from 5 m³/h to 700 m³/h capacity and pressures up to 8.0 bar.
- **Cost-effective:** Requires minimal investment with rapid ROI.
- **Modular:** Available in four models including two that do not require a booster pump.



NetaFlex3G™

The NetaFlex3G™ is a reliable, state-of-the-art, open-tank dosing system ensuring very precise and even nutrient dosing for greenhouse crops.

A CE-compliant modular system, the NetaFlex™ easily integrates with multiple Netafim™ and third-party control and monitoring systems, while delivering a uniform quantity or ratio of nutrients.

- **Productive:** Employs precise EC and pH control to assist in delivering a high-quality product with outstanding yields.
- **Uniform:** Delivers a consistent quantity or ratio of nutrients in a homogenous solution thanks to an open mixing tank design.
- **Flexible:** Works with a wide range of dosing channel flow rates up to 6 units of 50-600 l/hr.
- **Scalable:** System flow rates from 5 m³/h to 60 m³/h capacity.
- **Focused:** Made for greenhouse applications.



NetaJet3G™

The NetaJet3G™ is a uniform low-energy dosing system featuring a state-of-the-art mixing chamber.

It provides the highest level of dosing precision and uniformity for greenhouse and open-field crops.









A CE-compliant modular dosing system, the NetaJet3G™ easily integrates with multiple Netafim™ and third-party control and monitoring systems.

- **Productive:** Employs precise EC and pH control to deliver consistently high-quality product with outstanding yields.
- **Uniform:** Delivers a consistent quantity/ratio of nutrients thanks to an innovative mixing chamber while maintaining perfect EC and pH control.
- **Flexible:** Works with a wide range of dosing channel flow rates up to 5 units of 1000l/hr dosing channels.
- **Cost-efficient:** Using a single pump for mixing and injection of nutrients, the NetaJet3G is designed to accurately dose with low levels of energy consumption.
- **Scalable:** Scales from 5 m³/h to 400 m³/h capacity and pressures up to 6.5 bar.
- **Versatile:** Suitable for applications ranging from greenhouses to net houses.



DRIP IRRIGATION SYSTEM OVERVIEW

Select the appropriate dosing unit:

	Number of dosing channels	Dosing unit	Required energy resource	Open field / orchard	Greenhouse - soil / net house	Greenhouse - soilless	Comments
Single		Fertilizer tank		●			Will work only if the pressure difference between inlet and outlet is at least 0.3 bar (3 meters).
		Hydraulic piston motor injector		●			Consumes water 3 times the quantity of the chemical injected.
		Netafim™ Venturi injector		●			Requires 15-75% pressure differential for optimal operation, according to the required injection rate.
		Electric dosing pump		●			
		Hydraulic fertilizer injector (proportional)		●			Requires 15-30% pressure differential for optimal operation, according to the required injection rate.
		Single channel Mini FertiKit		●			
Multiple		FertiKit3G™	 or 	●	●		
		NetaFlex3G™			●	●	
		NetaJet3G™			●	●	

Legend:



Electricity is available on site.



Extra pressure is available in the system in addition to the required pressure for current irrigation.

For detailed technical data, see the product's datasheet at <http://www.netafim.com/irrigation-products-technical-materials>.

For clarifications or in case of doubt consult a Netafim™ expert.

DRIP IRRIGATION SYSTEM OVERVIEW

Dripperlines (laterals)

Dripperlines are at the heart of a drip irrigation system. In any irrigation system, the design process starts at the plant and proceeds to dripperline design. It is important to know what to take into consideration during dripperline design: dripperline selection, wall thickness, dripper flow rate, spacing between drippers, spacing between dripperlines, and specification of dripperline insertion depth (in SDI).

Basic terms regarding dripperlines:

Structure of the cross section of a pipe

- The Outside Diameter (OD) of the pipe is the distance between the outside walls of the pipe, measured perpendicularly to the pipe's axis.
- The Inside Diameter (ID) of the pipe is the distance between the internal walls of the pipe, measured perpendicularly to the pipe's axis.
- Wall Thickness (WT)

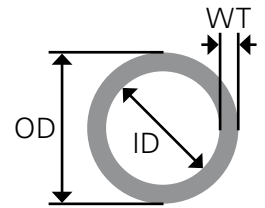

$$\text{Pipe's Inside Diameter} = \text{ID} = \text{OD} - (2 * \text{WT})$$

$$\text{Pipe's Wall Thickness} = \text{WT} = \frac{\text{OD} - \text{ID}}{2}$$

$$\text{The area of the inside pipe's cross-section} = \text{A} = \frac{\pi \text{ID}^2}{4} = \pi r^2$$

- $\pi = 3.1416$
- $r = \text{ID}/2$

Uniformity and efficiency

Uniformity saves water and fertilizer and improves yield, resulting in shorter ROI.

Efficiency saves resources and preserves the environment while optimally serving the crop's needs.



ATTENTION

Low startup costs can result in high annual operating costs. When designing a drip irrigation system it is important to consider uniformity and efficiency in order to keep total cost low.



NOTE

By international standards, 10% flow variation is considered uniform irrigation.

For more details and [calculations of uniformity and efficiency](#), see pages 49.

Drippers

The drippers incorporated at uniform spacing along the dripperline deliver water and nutrients directly to the plant root zone.

A typical drip irrigation system includes thousands of drippers. Each dripper should be durable, resistant to clogging, and emit the same amount of water. Wide water passages guarantee long-term trouble-free performance.

The flow rate and spacing of the drippers is important in determining the wetting pattern and for the prevention of runoff or deep percolation.

A properly operated and maintained drip irrigation system provides water and nutrients to the crop root zone without runoff or deep percolation.

DRIP IRRIGATION SYSTEM OVERVIEW

Two types of integral drippers are available:

Non pressure compensated drippers

Non-PC drippers supply a flow rate that is based on the working pressure.

- The dripper flow rate, pipe diameter and dripper spacing determine the pressure head losses in water flow within the dripperline.
- Differences in topographic heights also affect the system.

These two factors produce small differences in the dripper flow rates within the same dripperline.

Non-PC Dripper

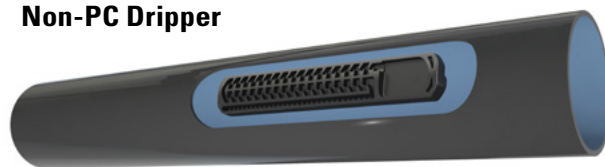

Pressure Compensated (PC) drippers

As long as the working pressure remains within the allowable pressure range, PC drippers provide uniform irrigation by maintaining a constant flow rate regardless of the working pressure.

The diaphragm is activated by the continual differential pressure created by the dripper's labyrinth, thus maintaining a constant dripper flow in a wide pressure range.

PC Dripper



Thanks to the free-floating diaphragm, the dripper's action is precise, immediate, sensitive, continually self-adjusting and constantly self-flushing. Particles that cause clogging will either be flushed out through the wide water passages or increase the pressure differential. This causes the diaphragm to momentarily increase the cross-section volume for outgoing water, and thus flush the dirt out of the system.

The diaphragm movement maintains constant differential pressure within the water passage, resulting in a uniform flow rate at a wide pressure range.

Additionally, Netafim™ PC drippers have the added benefit of the exclusive constant self-flushing feature, which aids in the prevention of clogging.



NOTE

PC drippers deliver the same flow rate regardless of the dripperline length (as long as the drippers operate within its working range as determined by the manufacturer).

PC drippers for particular applications:

Anti-Siphon (AS) drippers

The anti-siphon (AS) mechanism prevents suction of dirt into the dripperline, providing critical protection against dripper clogging. Ideal for subsurface drip irrigation (SDI).

Irrigation systems do not usually operate during rain. Rain often causes saturation of the soil or standing water around the dripperlines. Between irrigation cycles, when the system is not pressurized, it acts as a drainage system and pollution, if ingested, can lead to drippers' clogging.

To overcome this problem, the anti-siphon mechanism seals the dripper when the system is not pressurized, thus preventing pollutants from entering the system.

Compensated Non-Leakage (CNL) drippers

The CNL feature prevents system drainage between irrigation cycle, when the system is not fully pressurized. It ensures uniform water and nutrient distribution during pulse irrigation.

Dripperlines remain full between irrigation cycles, eliminating drainage and refill of the dripperlines, thus saving water.

DRIP IRRIGATION SYSTEM OVERVIEW

Determining the type of dripper to use

The type of drippers to be used should be selected according to the project's needs and characteristics. Although it is up to the grower to decide which type of drippers to use for a specific crop, the following recommendations should be considered:

It is strongly recommended to use PC drippers when:

- The terrain slope is greater than 2%.
- There are topographic variations along the dripperline.
- For long dripperlines.
- The crop is highly sensitive to excessive or insufficient irrigation.
- In orchards, where poor irrigation uniformity would cause inequality in growth of individual perennial plants (the longer the plant's life, the greater the disparity between individual plants).
- Perfect water distribution and uniformity are required.



NOTE

For subsurface systems always prefer anti-siphon (AS) drippers.

On-line drippers

Netafim™ offers a comprehensive line of on-line drippers with all the features and benefits of its integral drippers. Designated mainly for greenhouse, nursery and fruit tree applications.

Netafim's on-line pressure-compensated (PC & PCJ) drippers ensure precise, efficient and uniform flow distribution over the entire growing area and high resistance to common chemicals and nutrients.

Spider assembly

Netafim™ offers growers a range of micro tubes, manifolds and/or end-line products which, when connected to on-line drippers can be used to direct water flow to a specific location or to irrigate a variety of points. For more details about Netafim's assembly products, refer to the Netafim™ Accessory Catalog, at <http://www.netafim.com/irrigation-products-technical-materials>.

Dripperline selection and layout design

With any irrigation system, the design process starts at the plant and works "upstream". Hydraulically speaking, this means that the first part of the design process of an irrigation system is dripperline design consisting of dripperline selection and spacing between dripperlines in the field.

Dripperline selection involves consideration of spacing, pipe diameter and wall thickness, and dripper flow rates.

Consideration must also be given to connections between the dripperlines to the supply and flushing manifolds.

Dripper spacing depends on flow rate and soil characteristics. In general, coarser textured (sandy) soils will require shorter dripper spacing than a finer textured (clayey) soil, since coarse soils allow less lateral water movement.



NOTE

The dripperlines must be selected not only to allow the flow rate necessary for normal irrigation but also to allow sufficient flow rate for proper flushing velocities in the system (see [Flushing the dripperlines](#), page 74).

Dripperline spacing depends on the crops to be grown, the processing method and the agro-machinery to be used.

Oftentimes there will be a critical crop in rotation that will dictate spacing. In rotations that include a row crop, dripperline spacing is most often a multiple of the row spacing.

DRIP IRRIGATION SYSTEM OVERVIEW

Dripperline length is determined by field length and layout, allowable pressure (and therefore flow) variation within a zone, and flushing considerations.

Dripperline length also needs to be specified; along with dripperline's diameter, this will affect flow rate uniformity and impact flushing requirements and flow variations (particularly with drippers that are not Pressure Compensated).

When determining the type of dripperline to be used and deciding on the distance between dripperlines, also consider the plot geometry and the work practices.

In some regions, many fields are irregularly shaped, and therefore may have dripperlines of different lengths.

Netafim™ offers a wide selection of dripperlines suitable for various irrigation needs

Thin-walled dripperlines

- Suitable for 1-3 growing seasons.
- Especially fit for vegetables and field crops.
- Can be deployed at the beginning, and rolled-up at the end of each growing season.

Medium-walled dripperlines

- Suitable for 4-9 growing seasons.
- Designed for on-surface and subsurface (SDI) applications.
- For perennial plants, row crops and industrial row crops.

Thick-walled dripperlines

- Suitable for 10 or more growing seasons.
- Designed for a working life of many years in on-surface and subsurface (SDI) applications.
- For perennial plants, fruit trees, vineyards and the like.

Decoding the commercial name of Netafim™ dripperline models:

The name consists of 5 digits.*

Thin- and medium-wall dripperlines

- The first two digits represent the pipe's inside diameter (ID) rounded.
- The three last digits represent the pipe's wall thickness (WT) in mil.
(1 mil = 1/1000 inch = 25.4/1000 mm = 0.0254 mm).

Thick-wall dripperlines

- The first two digits represent the pipe's outside diameter (OD) rounded.
- The three last digits represent the pipe's wall thickness (WT) in millimeters (mm).

*The 5-digit commercial names of the dripperline models in the tables opposite are intended for identification purposes only and do not represent the exact diameter and wall thickness of each dripperline. For accurate data, refer to the Technical Datasheet of the specific product at <http://www.netafim.com/irrigation-products-technical-materials>.



NOTE

The maximum allowed flushing pressures in the tables are valid when flushing for a maximum of half an hour consecutively, with the end of 5 or more dripperlines kept open.

DRIP IRRIGATION SYSTEM OVERVIEW

Thin-walled dripperlines

Dripperline model	Pipe's inside diameter (ID) (mm)*	Wall thickness		Max. working pressure (bar)	Max. flushing pressure (bar)
		(mm)	(mil)		
12060	12	0.15	6.0	1.4	1.6
12080	12	0.20	8.0	1.7	2.0
12125	12	0.31	12.5	2.5	2.9
12150	12	0.38	15.0	3.0	3.5
16060	16	0.15	6.0	0.8	0.9
16080	16	0.20	8.0	1.0	1.2
16100	16	0.25	10.0	1.2	1.4
16125	16	0.31	12.5	1.8	2.1
16150	16	0.38	15.0	2.2	2.5
22080	22	0.20	8.0	0.8	0.9
22100	22	0.25	10.0	1.0	1.2
22135	22	0.34	13.5	1.5	1.7
22150	22	0.38	15.0	1.8	2.1
25135	25	0.34	13.5	1.2	1.4
25150	25	0.38	15.0	1.4	1.6
35135	35	0.34	13.5	0.9	1.0
35150	35	0.38	15.0	1.0	1.2

Medium-walled dripperlines

Dripperline model	Pipe's inside diameter (ID) (mm)*	Wall thickness		Max. working pressure (bar)	Max. flushing pressure (bar)
		(mm)	(mil)		
12200	12	0.50	20.0	3.0	3.5
12250	12	0.63	25.0	3.5	4.6
16200	16	0.50	20.0	2.5	3.3
16250	16	0.63	25.0	2.8	3.6
16007	16	0.70	27.0	2.9	3.8
16008	16	0.80	32.0	3.0	3.9
22250	22	0.63	25.0	2.5	2.9

Thick-walled dripperlines

Dripperline model	Pipe's outside diameter (OD) (mm)*	Wall thickness		Max. working pressure (bar)	Max. flushing pressure (bar)
		(mm)	(mil)		
12010	12	1.00	39.0	3.5	4.6
16009	16	0.90	35.0	3.0	3.9
16010	16	1.00	39.0	3.5	4.6
16012	16	1.20	47.0	4.0	5.2
17012	17	1.20	47.0	4.0	5.2
20010	20	1.00	39.0	3.5	4.6
20012	20	1.20	47.0	4.0	5.2
23009	23	0.90	35.0	3.0	3.5
23010	23	1.00	39.0	3.0	3.5

*The outside diameter (OD) and the inside diameter (ID) of the dripperline models and the data in the tables above are intended for identification purpose only and do not represent the exact diameter and wall thickness of each dripperline. For accurate data, refer to the Technical Datasheet of the specific product at <http://www.netafim.com/irrigation-products-technical-materials>.

DRIP IRRIGATION SYSTEM OVERVIEW

Connectors

Netafim's comprehensive range of dripperline connector systems is made of high resistance and high durability polymers. They are functional and viable, moulded under the highest market standards and available for all dripperline types. Use the catalog to select the right line for your application: barb connectors, fast ring connectors, flare connectors and a vast family of start and reducing connectors.

Connectors technical data

Connectors for thick walled dripperlines

Dripperline			Subsurface installation		Features	
Commercial name	Inside Diameter (ID) (mm)	Wall Thickness (WT) (mm)	Deep insertion	Shallow insertion	Allows laying/recoiling	Reusable
Barb						
12	10.2	1.0-1.2	+	+	+	-
16	14.2	0.9-1.2	+	+	+	-
17	14.6	1.2	+	+	+	-
20	17.5	1.0-1.2	+	+	+	-
Flare for HWD (orange nut)						
16-17	14.2-14.6	0.9-1.0	-	+	+	+
20	17.5	0.9-1.0	-	+	+	+
23	20.8	0.9-1.0	-	+	+	+

Connectors for thin/medium walled dripperlines

Dripperline			Subsurface installation		Features	
Commercial name	Inside Diameter (ID) (mm)	Wall Thickness (WT) (mil)	Deep insertion	Shallow insertion	Allows laying/recoiling	Reusable
Ring fast connectors						
16 blue ring	16.2	6.0-25.0	⊘	+	-	+
16 black/white ring	15.5	27.0-32.0	⊘	+	-	+
22 blue ring	22.2	8.0-25.0	⊘	+	-	+
25 black ring	25.0	13.5-15.0	⊘	+	-	+
Flare for TWD (blue nut)						
12	11.8	6.0-25.0	-	+	+	+
16	16.2	6.0-20.0	-	+	+	+
22	22.2	8.0-25.0	-	+	+	+
25	25.0	13.5-15.0	-	+	+	+
35	35.0	13.5-15.0	-	+	+	+
Twist lock (TWD)						
16	16.2	6.0-20.0	+	+	⊘	+
22	22.2	8.0-25.0	+	+	⊘	+
25	25.0	13.5-25.0	+	+	⊘	+

⊕ Suitable ⊖ Not suitable ⊘ Suitable but not recommended

For full information, see Connectors Catalog at

<http://www.netafim.com/irrigation-products-technical-materials>.

DRIP IRRIGATION SYSTEM OVERVIEW

End of dripperlines

Dripperline flushing manifold

The flushing manifold at the end of the dripperlines is fitted with a flushing riser and valve to allow flushing of the dripperlines. When the flushing valve is opened, flow rate and velocity through the dripperlines are greater than those in normal operational mode. The higher flow velocity allows removal of settled solids and precipitants from the system, preventing them from clogging the drippers.

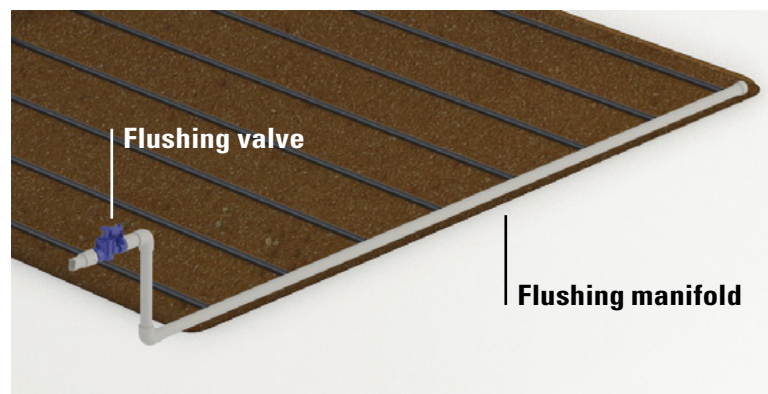

Flow regimes may be quite complicated in irregularly-shaped fields with different dripperline lengths within the same irrigation zone.

Since SDI zones with flushing manifolds are closed-loop systems, pressure tends to equilibrate and zones with differing dripperline lengths are designed using an average dripperline length. Flushing manifold pipe sizes are determined in consideration of the flow through the end of the dripperlines during flushing.

The flushing manifold is sized for a flow velocity of at least 0.5 m/sec (1.65 ft/sec) through the dripperlines to ensure sediment removal.

Flushing will temporarily increase the flow requirements of the system, which in turn will decrease the system pressure. In some cases, in order to achieve the desired velocity, especially with pressure regulated zones or with irregular field shapes, the planning of the system may require large amounts of piping to connect the ends of all the dripperlines in a particular section or zone.

A careful balance between flushing velocities in the manifolds and in the dripperlines is critical.



When zones are relatively large, to enable the pumping system to supply the flow rate required to achieve the desired flushing velocity at the ends of the dripperlines, the irrigation zone is divided into two or more flushing manifolds. This separation will allow maintenance of a proper flushing pressure.

Another solution to supply the flow rate required for flushing is to use an additional pump at the head of the system. The additional pump will be activated only during flushing to add the missing flow rate.

DRIP IRRIGATION SYSTEM OVERVIEW

Other flushing solutions

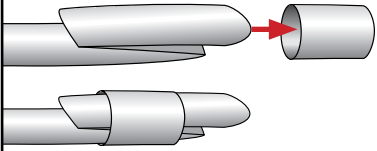
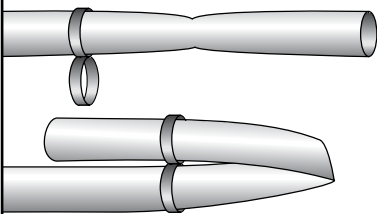
It is possible to flush the dripperlines manually. There are a number of ways to do this:

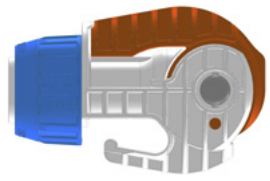
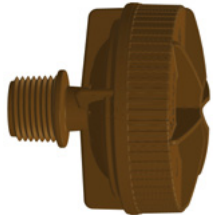
Solution	Description	Advantages	Disadvantages
Folded dripperline end	<ul style="list-style-type: none"> • Cut a 5 cm sleeve from the end of the dripperline. • Fold the end of the dripperline in the shape of a "z" and slip the sleeve over the end. 	<ul style="list-style-type: none"> • Least expensive solution. • Allows flushing of the dripperlines one by one under optimal conditions. 	<ul style="list-style-type: none"> • Requires extensive labor time. • Reinstalling the sleeve while the dripperline is still pressurized is difficult.
End of line removable connector	<ul style="list-style-type: none"> • Slip one loop of the connector onto the dripperline. • Fold the end of the dripperline and slip it into the connector's other ring over the end.  	<ul style="list-style-type: none"> • Allows flushing of the dripperlines one by one under optimal conditions. 	<ul style="list-style-type: none"> • Requires extensive labor time.
Dripperline manual valve	<ul style="list-style-type: none"> • Pulling the orange handle to the upwards position opens the end of the dripperline for flushing. 	<ul style="list-style-type: none"> • Allows flushing of the dripperlines one by one under optimal conditions. • Requires less labor time. 	<ul style="list-style-type: none"> • None
Automatic flushing valve	<ul style="list-style-type: none"> • Flushes all the dripperlines of the irrigation shift at the start of each irrigation event without human intervention. 	<ul style="list-style-type: none"> • All dripperlines are flushed at the start of each irrigation event. • Excellent flushing frequency. 	<ul style="list-style-type: none"> • All dripperlines in each irrigation shift are flushed at the same time. • For correct operation an additional flow rate of 300 l/hr is required for each automatic flushing valve operated in the irrigation shift.

DRIP IRRIGATION SYSTEM OVERVIEW

Sensors

In order to make full use of the advantages of a drip irrigation system, it is important to regularly monitor the actual condition of the soil, the irrigation water and the crop. To easily collect useful data for the management of the irrigation system, Netafim™ offers a comprehensive range of high-quality sensors, either standalone or connectable to a Netafim™ CMT controller.

Tensiometer

A tensiometer measures soil moisture. It is an instrument designed to measure the tension or suction that a plant's roots must exert to extract water from the soil. This tension is a direct measure of the availability of water to a plant.

Tensiometers may be used in any irrigated crop; however, it is with horticultural crops in particular that they provide a suitable method to aid irrigation decisions.

The measurement of soil moisture with a tensiometer provides a valuable tool to schedule irrigation. Tensiometers are particularly useful to determine when to irrigate, and can be used to support a schedule based on estimation of crop water use from reference crop evapotranspiration (EVT) data.

A tensiometer consists of an air tight, water filled tube with a porous ceramic tip at the bottom and either a vacuum gauge at the top or a re-sealable rubber bung designed to insert a portable vacuum meter. During the irrigation season the tensiometer is partly inserted into the soil to a suitable depth and, when used properly, will enable improved irrigation management by accurately determining when water should be applied to maintain optimum crop growth and how much water should be applied to avoid over-irrigating.

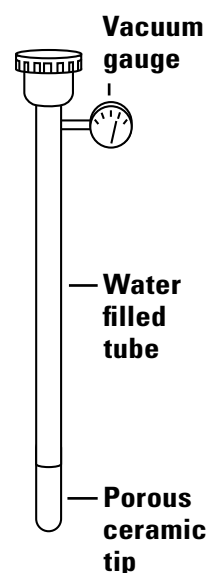

Placement of tensiometers

It is recommended to use 3 tensiometers in each tensiometer station. Correct placement is very important. Each tensiometer should be installed with its ceramic tip at a different depth (e.g. 30, 60 and 90 cm or 12, 24 and 36 inches) according to the type of crop (consult an agronomist).

The upper tensiometer placed at the top of the root zone, provides data regarding the development of the wetted bulb in the soil and indicates when it is time to irrigate.

The middle tensiometer placed at approximately the midpoint of the main fibrous root system (where irrigation water is certain to wet the soil), provides data regarding the wetness of the soil in the root zone. Placement too deep in a shallow rooted crop will result in the crop being irrigated too late and suffering water stress. Shallow placement in a deep rooted crop may result in excessive irrigation and water logging of the deeper roots.

The lower tensiometer placed at the bottom of the root zone serves as a safeguard against excessive irrigation by providing data regarding runoff or deep percolation. Used to determine if too much (never reads above 15 kPa) or too little water (continues to rise) is being applied in each irrigation.

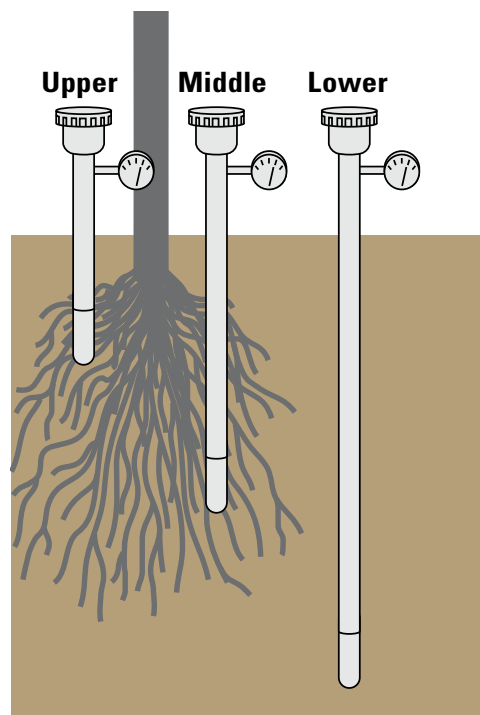

DRIP IRRIGATION SYSTEM OVERVIEW

Locating tensiometer stations

In most situations two sites will be needed for each major species or variety and soil type. Avoid high or low locations, zones of poor water infiltration, and areas that are lightly watered because of bad irrigation distribution patterns. All tensiometers must be marked clearly to avoid damage from traffic, workers and cultivation.

For [tensiometer operation and reading](#), see page 93.



Pressure sensor

The pressure sensor, installed on a specific lateral, main or sub-main line, provides actual and accurate reading of water pressure. Netafim's electrical pressure sensor is available in 2 models: 0-6 bar and 0-2 bar.

When connected to the uManage™ real-time crop management decision support system, pressure can be presented graphically or in a detailed report.

This data is critical for cross-referencing between irrigation events, filter blocking, etc.

The pressure sensor can be used to measure the level of water in a storage tank and the level of liquid solution in a fertilizer tank.



Ech₂o sensor

The Ech₂o soil moisture probe is a capacitance-type sensor that measures the dielectric constant or permittivity of the material in which it is inserted, by finding the rate of change of voltage on the sensor that is embedded in the medium. Water has a permittivity of about 80, while the value for soil minerals is around 4, and for air is 1. The high permittivity of water relative to soil minerals and air results in relatively large changes in the permittivity of soil when the water content changes.

The Ech₂o sensor is designed to remain in the soil permanently or for an entire growing season and requires no maintenance.



NetaSense sensor

The NetaSense sensor is a volumetric soil moisture sensor based on TDT (Time Domain Transmission) technology that provides an immediate and accurate response to changes in soil moisture levels.

This sensor is able to indicate changes in moisture by means of measuring the speed of an electromagnetic wave.

The sensor is designed to be installed and left in the soil for the entire duration of the crop, or permanently. The sensor components are stainless steel and all interfaces are sealed in epoxy to provide years of reliable service. The sensor is reliable in any type of soil.

The NetaSense sensor is capable of measuring a large soil volume at a 5-cm (2-inches) radius from its elements. It reports the average soil moisture along its active length - about 30 cm (12 inches), whether the sensor is installed vertically or horizontally.



DRIP IRRIGATION SYSTEM OVERVIEW

Controller

The best way to make full use of the advantages of a drip irrigation system is by controlling it using an irrigation controller.

Netafim™ offers an extensive range of controllers for precise monitoring and management of water and nutrient supply to the field, making full use of the exceptionally high efficiency and uniformity capacity of the drip irrigation method.

- Lower water, nutrient, chemicals and energy usage
- Lower labor requirements
- Real-time corrective actions
- Greater crop sustainability
- Increased productivity
- Enhanced yields
- Rapid ROI

Netafim's NMC irrigation controllers are modern irrigation control systems with advanced features for handling irrigation main lines including pumps, filters, fertigation systems and other accessories related to the full comprehensive solution for farm management. The NMC line of controllers offers a range of optimal solutions for open field, greenhouse and nursery applications.

Controls:

- **Irrigation valves** - Irrigation control based on time and quantity.
- **Irrigation pumps** - Optimized pump control according to flow and pressure.
- **Filter flushing** - Based on time or pressure differential between the filter inlet and outlet.
- **Pressure sustaining valves** - Adjustment of the main line pressure when filter flushing is in process.
- **Fertilizer pumps** - Control of fertilizer injection according to the type of fertilizer pump and its flow rate.
- **Fertilizer tank selector** - Optimization of the fertilizer usage when various crop varieties require different recipes.
- **Fertilizer agitation** - Control the agitators in the fertilizer tanks to maintain homogeneous solution.
- **Cooling system** - For greenhouse and nursery applications. Operates Netafim's sprinklers to cool down the greenhouse temperature according to the plant needs.
- **Misting system** - For greenhouse and nursery applications. Operates Netafim's sprinklers to increase the relative humidity according to the plant needs.
- **Alarm device** - Generates an alarm in the occurrence of a malfunction or any unusual event. Alarm can pop up on the computer screen, be e-mailed or sent as an SMS or push notification to smartphones.

Monitors:

- **Water meters** - Monitor the irrigation volume and flow rate. Makes sure that water in the system is flowing as planned with no leakages or clogging issues.
- **Fertilizer meters** - Monitor the fertilizer flow rate and amount.
- **EC and pH sensors** - For advanced and accurate fertilizer control.
- **Temperature & humidity sensors** - For cooling and humidification.
- **Weather station** - For irrigation control based on evapotranspiration and for frost mitigation.
- **Pressure sensors** - For filter flushing and irrigation control.
- **Tensiometer sensors** - Measure water tension in the soil for the assessment of the field capacity.
- **Soil moisture sensors** - Measure the volumetric water content in the soil for correct timing and precise volume of irrigation.
- **General purpose sensor** - Netafim's NMC controllers can monitor any type of 0-5 VDC or 4-20 mA sensor according to customer needs.

DRIP IRRIGATION SYSTEM OVERVIEW

Netafim™ NMC irrigation controllers

NMC Pro

- Top of the line irrigation controller
- Features powerful hardware and software for greenhouse and open field applications
- Meets the most modern demand for smart, efficient irrigation
- Can manage up to 255 irrigation valves



NMC Junior

- Multi-function irrigation controller for small applications
- Can manage up to 15 irrigation valves
- Advanced solution for simple greenhouse applications



Netafim™ NMC climate controllers

NMC Climate

- Comprehensive solution for greenhouse applications
- Can manage up to 50 greenhouses simultaneously
- Controlled by advanced PC software with a user-friendly interface



Mist-Guard

- Option 1: Misting controller for cooling applications
- Option 2: Ultimate stand alone controller for high precision with built in temperature and humidity sensors



Netafim™ NMC multi main lines irrigation controller

NMC XL

- Multi main lines irrigation controller
- Optimal solution for open field application
- Controls up to 25 central Nutrigation™ stations
- Controls up to 128 irrigation lines including flow measurement, filter flushing and local Nutrigation™



Netafim™ NMC Remote Terminal Units (RTU)

RadioNet

- Continuous wireless monitoring and ultimate control at distance
- Easy-to-use modular system ensuring reliable and flexible control over remote terminal units to increase productivity and address constantly changing needs
- Multi interface enables connection to a wide range of controllers
- Up to 254 remote units including S&F



SingleNet

- Up to 10 Km cable length
- Reduced installation and cable cost
- Multi interface enables connection to a wide range of controllers
- Up to 128 remote units



DRIP IRRIGATION SYSTEM OVERVIEW

Accessories and add-ons

For ease of implementation, current operation and maintenance of a Netafim™ drip irrigation system, Netafim™ offers a wide variety of useful accessories and add-ons designed to facilitate day to day tasks and to allow the addition of practical functions to the system. Below is a shortlist of selected accessories and add-ons; for the full range see Fittings & Accessories Product Catalog at <http://www.netafim.com/irrigation-products-technical-materials>.

Dripperline Non Leakage valve (DNL)

A spring-loaded diaphragm actuated valve that opens upon pressurizing the irrigation system and shuts off drip-tight when the system reaches closure pressure. For intensive irrigation and sloped fields, where irrigation precision is imperative.



Direct pressure regulator

A spring-actuated control regulator that reduces higher upstream pressure to lower constant downstream pressure, and opens fully upon line pressure drop.

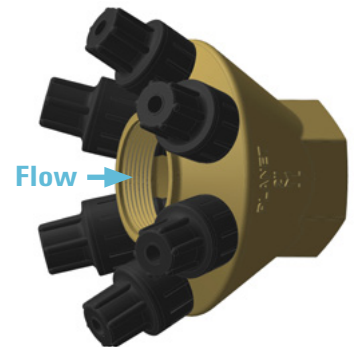

Pressure flag-indicator

Provides visual indication of water pressure in all drip applications. Installed on dripperlines at the farthest end of the irrigated plots, enables quick and easy inspection of proper delivery of water through the system from a distance.



Hanging accessories, stakes and spikes

For a well implemented installation and ease of operation and maintenance, Netafim™ offers a wide variety of hanging accessories, stakes and spikes, enabling professional and convenient installation.

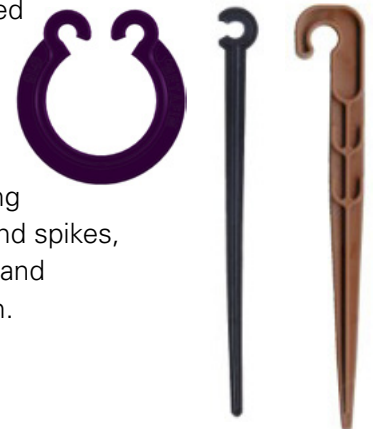

Adapters and manifolds

A vast line of complementary products, families of models and sizes.



Punches and tools

To facilitate the installation and the current maintenance of the irrigation system, Netafim™ offers a variety of dedicated tools for ease of work and prevention of damage to the system components.



DRIP IRRIGATION SYSTEM OVERVIEW

Agro-machinery

Based on the field experience and the knowledge gathered by Netafim™ over many years of operation, the company offers a wide variety of application and auxiliaries tools designed for simple, rapid and efficient installation and removal of dripperlines while maintaining their integrity and avoiding damage to the drippers.

Subsurface insertion machinery

Subsurface insertion machines enable any grower to install dripperlines in a cost effective and efficient manner.

The features incorporated in this tool ensure that the dripperline insertion procedure is done accurately.

The use of wear resistant materials guarantees the integrity of the inserted dripperline.

A special plastic guide located on the insertion shank will eliminate problems associated with twisted and/or kinked dripperlines.

A wide variety of machines is available for shallow, medium or deep subsurface insertion of thin-, medium- or thick-walled dripperlines in open fields, orchards, row crops, trees, sugarcane and many options including covering tools, multiple insertion, shallow insertion machine with roller, dripperline releasers and more.



Laying and retrieving machinery

Laying machinery

Laying machines are designed to perform on-surface installation of thin, medium, and thick-walled dripperlines in a proper, speedy and safe manner.

Multi optional mounting of laying units on toolbar frames enables Netafim™ to offer a wide variety of products and modular units according to the grower's specific requirements.

Also available are auxiliary tools such as worker seat, storage device for spare dripperline coils, laying device for cardboard, plastic and metal reels, etc.



Retrieving machinery

The features incorporated into this machine's design ensure that dripperline retrieval for reuse and/or disposal is performed quickly and properly.

The following auxiliary tools can be mounted on the agro-machinery to optimize procedures: brush, arranger, and pulling device ensuring the constant maximal pulling force permitted for exertion on the dripperlines (different pipe diameters and wall thickness types require different maximal pulling force).



DRIP IRRIGATION SYSTEM OVERVIEW

Extraction machinery

This machine was designed for the growers who wish to re-use subsurface applied dripperlines.

The units can be used as single or multiple units mounted on a toolbar.

Rear or front mounted models are available.

A control system matches extraction speed to tractor speed and controls pulling tension.

The pneumatic pulling tires gently squeeze all water out of the dripperline and lay it down on the surface to await head retrieval.



Accessories

A wide variety of mountable, utility accessories for the machines, are available and can be purchased as spare parts for replacement. The accessories can also assist in the assembly of integrated machines and/or use for individual functions in various periods of the growing season.

Most common accessories:

- Roller Box*
- Deep and Mid Depth Insertion Shanks*
- Recycling Devices for Thick-/Thin-Walled Dripperlines
- Reel Holders and Coil carriers
- Reels - Metal or Reusable
- Wheel Units, Pneumatic Depth Wheels
- Storage/ Worker Platforms
- Furrowers
- Covering Legs



ATTENTION

*In order to avoid damage to the dripperlines in the insertion or laying process, always use a Roller Box and an Insertion Shank supplied by Netafim™. These two accessories are especially engineered and made of wear resistant materials to guarantee the integrity of the inserted dripperline of any type or grade.

See Instructions for [dripperline insertion and laying](#), page 63.

For further information about agro-machinery see the Agro-Machinery Catalog at <http://www.netafim.com/irrigation-products-technical-materials> or call your local Netafim™ representative.



DRIP IRRIGATION MANAGEMENT AND OPERATION

Irrigation	48
Nutrigation™	52
Nutrigation™ via a drip irrigation system	55
Chemigation	61
Dripperline insertion or laying	63

DRIP IRRIGATION MANAGEMENT AND OPERATION

The aim of this chapter is to provide guidelines and useful tips for the proper management and operation of a drip irrigation system.

Irrigation

Hydraulic parameters

The following hydraulic parameters are considered when designing an irrigation system. All are inter-related and a change in one parameter will affect system results:

Parameter	Definition	Measurement	Units
Q	Dripper flow rate	Amount of water provided by the dripper at a given time unit during the irrigation process	l/hr - liters per hour
E	Distance between drippers	Distance between two drippers on a distribution pipe	m - meters
D	Distance between dripperlines	Distance between two dripperlines	m - meters
Pr	Precipitation rate	The amount of water per area for a specified period of time	mm/hr - millimeters per hour
HIR	Hourly irrigation rate	Quantity of water the system will irrigate during one hour for a specified area	m ³ /Ha/hr - cubic meter per hectare per hour
DWR	Daily water requirement	Quantity of water the crop requires per day (based on pan evaporation or the Penman-Montieth equation , see page 90)	mm/d - millimeters per day, or m ³ /Ha/d -cubic meter per hectare per day (mm/day * 10)
T	Irrigation Time	Time required to irrigate a certain area	hr - hours
S	Shift number	Shift number of each irrigation shift into which the irrigation time is divided	Integer
N	Daily shift hours	Total number of hours per day that the system irrigates the project	hr - hours

Hydraulic requirements

The hydraulic specification of an irrigation system must allow it to deliver the required amount of water to the crop at the time it needs it.

The most important aspect of crop water use for the design of a drip irrigation system is the “peak” water requirement or the amount of water that a crop uses during its highest water use period. This is because it is during this period that the system must deliver the greatest amount of water.

While rain may be factored in to reduce the irrigation requirement for a season, it should not be factored in when calculating a peak use rate.

Different crops and different planting dates will result in different water requirements. The irrigation system may be intended to irrigate more than one crop (rotation), in which case the crop with the highest water demand must be the design criterion.

DRIP IRRIGATION MANAGEMENT AND OPERATION

Uniformity and efficiency



ATTENTION

Low startup costs can result in high annual operating costs. When designing a drip irrigation system it is important to consider uniformity and efficiency in order to keep total cost low.

Uniformity is the ability of the irrigation system to deliver water and fertilizer as equally as possible to all the plants in the field or orchard. Uniformity saves water and fertilizer and improves yield, resulting in shorter ROI.

Efficiency is the ability of the irrigation system to deliver water and fertilizer according to the crop's needs as exactly as possible. Efficiency saves resources and preserves the environment while optimally serving the crop's needs.

Irrigation efficiency describes a field's performance. Water use efficiency is the ratio of the amount of irrigation water applied that is beneficially used by the plant, to the total amount of irrigation water applied.



NOTE

The higher the uniformity, the more efficient the use of water and energy.

Irrigation scheduling determines the actual overall efficiency of the irrigation system. If irrigation is improperly timed, in either frequency or duration, the field capacity of the soil in the root zone will be exceeded and the water will be lost to runoff or to deep percolation (see [Field Capacity](#), page 85). Depending on the crop, this may affect or not affect the crop negatively, but in any case will cause unnecessary costs.

Even with an irrigation system perfectly planned for high efficiency, improper duration of irrigation will eliminate most advantages gained by the design of the system.

Flow variation (FV) and emission uniformity (EU) play an important role in the overall uniformity of a drip irrigation system. These are the most applicable terms to drip irrigation systems; they are defined by the design of the system and are critical to its performance as it applies to irrigation efficiency.

Flow Variation (FV) expresses the flow variation between the dripper "sensing" the highest pressure and the one "sensing" the lowest pressure in an irrigation block (zone). These drippers will not always be the first and last drippers on the dripperline.

$$FV \% = \frac{Q \text{ max.} - Q \text{ min.}}{Q \text{ max.}} * 100$$



NOTE

By international standards, 10% flow variation is considered uniform irrigation.

DRIP IRRIGATION MANAGEMENT AND OPERATION

Emission Uniformity (EU)

Emission uniformity is calculated using four main variables:

- Q minimum = the minimum flow rate in the irrigation block
- Q average = the average flow in the irrigation block.
- CV = the manufacturing variation of the emission device, which should represent the manufacturing variation of the finished products that will be in the field.
- n = number of drippers per plant in the irrigation block (for permanent crop systems 'n' is the number of drippers per plant, where in row crops "n" carries a value of 1 due to the fact that a single dripper might be servicing multiple plants).

$$EU \% = 100 * 1 - \left(1.27 * \frac{CV}{\sqrt{n}} \right) * \frac{Q \text{ min.}}{Q \text{ average}}$$

If a designed irrigation block is calculated to have 15% flow variation, then the lowest flow point in this block is receiving 15% less water than the highest flow point in it.



ATTENTION

If an irrigation block design is calculated to have 90% emission uniformity, it is inaccurate to assume that the minimum flow point in the block is 10% lower than the high flow point in the block. A rule of thumb is that for every one (1) point change in EU there are approximately two points change in FV. Therefore a EU of 90% (10% below 100%) would have a FV closer towards 20%, meaning the lowest flow point in the irrigation block would actually have a flow rate closer to 20% lower than its highest flow point.

Hydraulic calculations



EXAMPLE

Calculating the Precipitation Rate (Pr)

Data

Dripper flow rate	Q = 0.5 l/hr
Distance between drippers	E = 0.5 m
Distance between dripperlines	D = 1.8 m

Calculation

Calculate the hourly irrigation rate as follows:

$$\text{Precipitation rate (Pr)} = \frac{Q}{(E \times D)} = \frac{0.5}{(0.5 \times 1.8)} = 0.55 \text{ mm/hr}$$

DRIP IRRIGATION MANAGEMENT AND OPERATION

Calculating the irrigation rate

There are two ways to calculate the irrigation rate.

Calculate the hourly irrigation rate (HIR) in cubic meters:

$$\text{Hourly Irrigation Rate (HIR)} = \frac{0.55 \text{ mm}}{\text{Ha} \times 10} = 5.5 \text{ m}^3/\text{Ha}/\text{hr}$$

Alternatively, we can calculate the hourly irrigation rate (HIR) by multiplying the number of drippers per Hectare by the hourly flow rate.

Calculate the hourly irrigation rate based on the number of drippers per hectare:

Data

Dripper flow rate $Q = 0.5 \text{ l/hr}$

Distance between drippers $E = 0.5 \text{ m}$

Distance between dripperlines $D = 1.8 \text{ m}$

Calculation

a. Calculate the total length of the dripperlines:

$$\text{Dripperline length}/\text{Ha} = \frac{10000 \text{ m}^2}{1.8} = 5555 \text{ m}$$

b. Calculate the total number of drippers per Hectare:

$$\text{Drippers}/\text{Ha} = \frac{5555 \text{ m}}{0.5} = 11,111 \text{ drippers}$$

c. Calculate the hourly irrigation rate:

$$\text{Hourly Irrigation Rate (HIR)} = \frac{11,111 \text{ drippers} \times 0.5 \text{ l/hr}}{1000} = 5.5 \text{ m}^3/\text{Ha}/\text{hr}$$

Calculating the Daily Water Requirement (DWR):

Data

Pan evaporation* $EV_{To} = 8.4 \text{ mm/d}$

Crop coefficient* $K_c = 0.75$

*see [Water budgeting](#), page 88.

$$\text{DWR} = 8.4 \times 0.75 = 6.3 \text{ mm/d} = 63 \text{ m}^3/\text{Ha}/\text{d}$$

Calculate the required irrigation duration (hours/day):

Data

Hourly irrigation rate $\text{HIR} = 5.5 \text{ m}^3/\text{Ha}/\text{hr}$

$$\text{Irrigation time} = \frac{\text{DWR}}{\text{HIR}} = \frac{63 \text{ m}^3/\text{Ha}/\text{d}}{5.5 \text{ m}^3/\text{Ha}/\text{hr}} = 11.45 \text{ hours (11 hours 27 minutes)**}$$

**Conversion of decimal hours to minutes: $\frac{\text{decimal hours}}{100} \times 60 = \frac{0.45}{100} \times 60 = 0.27 = 27 \text{ min}$

Conclusion

Based on the calculations, it takes less than 12 hours to irrigate the required area (63 m³/Ha/d). This means that the effective crop area can be doubled if the equipment is operated twice per day.

DRIP IRRIGATION MANAGEMENT AND OPERATION

Calculating the maximal irrigation area based on water supply

Knowing how much water is available per hour and the required quantity of water in m³/Ha/h enables us to calculate the maximal area that could be irrigated at once.

Data

Dripper flow rate	0.5 l/hr
Distance between drippers	0.5 m
Distance between dripperlines	1.8 m
Hourly irrigation rate	0.55 mm/hr
Daily return (equal to HIR)	6.3 mm/d
Daily hours/shift	11.45 hr
Possible number of shifts in 24 hours	2
Pump discharge	(10 l/sec) 36 m ³ /hr

Calculation

Calculate the maximal area that can be watered in 24 hours based on the data above:

$$\frac{\text{Pump discharge per hour} * \text{Daily hours/shift} * \text{numbers of shifts}}{\text{Daily return}} =$$
$$= \frac{36 \text{ m}^3/\text{h} * 11.45 \text{ hours/shift} * 2 \text{ shifts}}{63 \text{ m}^3/\text{Ha/d}} = 13 \text{ Ha}$$

Nutrigation™

Crops require a balanced diet of essential nutrients throughout their growth cycle.

Many plant foods can be found in the soil, but often in insufficient quantities to sustain high crop yields. Soil and climatic conditions can also limit a plant's uptake of nutrients at key growth stages.

Crop scientists recognize that plants need 13 essential minerals, all of which play a number of important functions. If any of these is lacking, plant growth and yield suffer.

Major nutrients

Nitrogen (N)

Is often required in the greatest quantity by crops, primarily for vigor and yield. Nitrogen plays a key role in chlorophyll production and protein synthesis. Chlorophyll is the green plant pigment responsible for photosynthesis. When nitrogen is deficient, plants develop yellow or pale leaves and their growth is stunted.

Phosphorus (P)

Is a vital component of adenosine triphosphate (ATP), which supplies the energy for many processes in the plant. Phosphorus rarely produces spectacular growth responses, but is fundamental to the successful development of all crops. For example, maize or other corn crops that lack phosphorus during the growing season achieve lower yields.

Potassium (K)

Is needed by virtually all crops and often in higher rates than nitrogen. Potassium regulates the plant's water content and expansion. It is key to achieving good yield and quality in cotton and critical for increasing the size, juice content and sweetness of fruit.

Secondary nutrients

Calcium (Ca)

Is perhaps the most important secondary nutrient. Calcium strengthens cell walls, helping to reduce bruising and disease in fruit, salad and vegetable crops. This means that a good supply of calcium produces food crops that are less prone to damage and have a longer shelf life. Crops with a calcium shortage will have growth disorders such as corky skin.

Magnesium (Mg)

Is also important for crop quality, and is also a key component of leaf chlorophyll and the enzymes that support plant growth. Low magnesium leads to reduced photosynthesis, which severely limits crop yields. Grain fill in rice and dry matter content of potatoes can be significantly reduced if magnesium is undersupplied.

Sulfur (S)

Is an essential part of many amino acids and proteins. Without both S and Mg, crops suffer; growth slows and leaves turn pale or yellow. Sulfur is particularly important for ensuring the protein content of cereal crop grains.

Micronutrients

Reinforce and supplement the strong plant growth and structures provided by major and secondary nutrients.

Manganese (Mn)

Influences photosynthesis, the process whereby plants use sunlight for growth.

Copper (Cu)

Influences photosynthesis, the process whereby plants use sunlight for growth.

Iron (Fe)

Influences photosynthesis, the process whereby plants use sunlight for growth.

Deficiencies are common – for example in seed fruits – where the effect is to reduce production of chlorophyll. As a result, crops struggle and younger leaves develop a severe yellowing or chlorosis.

Boron (B)

Is needed for the development of shoots and roots, and is essential during the flowering and fruiting phases of crops.

Zinc (Zn)

Is needed for the production of important plant hormones, like auxin. Zinc deficiency leads to structural defects in leaves and other plant organs.

Molybdenum (Mo)

Is involved in plant enzyme systems that control nitrogen metabolism.

DRIP IRRIGATION MANAGEMENT AND OPERATION

Element content (%) in fertilizers - Suitable for Nutrigation™

Fertilizer	Formula	Element									
		N	P ₂ O ₅	K ₂ O	Ca	Cl	Na	Mg	S	SO ₄	
Urea	CO(NH ₂) ₂	46									
Urea ammonium nitrate	CO(NH ₂) ₂ NH ₄ NO ₃	32									
Mono ammonium phosphate MAP	NH ₄ H ₂ PO ₄	12	61								
Ammonium nitrate	NH ₄ NO ₃	32									
Potassium nitrate	KNO ₃	13		46							
Calcium nitrate	Ca(NO ₃) ₂	15			19						
Calcium chloride	CaCl ₂				27	63					
Potassium chloride	KCl			61		47					
Potassium sulfate	K ₂ SO ₄			51					55	18	
Mono potassium phosphate MKP	KH ₂ PO ₄		52	34							
Ammonium sulfate	(NH ₄) ₂ SO ₄	21							24	73	
Magnesium sulfate	MgSO ₄							16	16	49	
Calcium sulfate	CaSO ₄				19				8	26	
Magnesium nitrate	Mg(NO ₃) ₂	11						10			
Sulfuric acid	H ₂ SO ₄								33		
Phosphoric acid	H ₃ PO ₄		61								
Nitric acid	HNO ₃	13									
Sodium chloride (salt)	NaCl					62	38				

Crop needs

Each crop needs a different range of nutrients at every critical stage of its development.

For example, nitrogen and phosphorous are often more critical at early stages of growth to fuel root and leaf development, whereas zinc and boron are important during flowering.

Cereal crops use nutrients for growth, progressively moving them from the roots, to the stems and leaves until the dying off and harvesting of the grain.

Tree crops have different nutrient requirements than field crops. They can store nutrients like nitrogen within their trunk, branches and leaves and then redistribute them at key points during the growth cycle. It is important, however, to supply trees with replacement levels of the nutrients removed in the harvested fruit and those that are critical for growth but can't be recycled.

The influence of soil pH on nutrient availability

Soil pH level has a specific influence on the availability of each nutrient to the crop ([see page 86](#))

DRIP IRRIGATION MANAGEMENT AND OPERATION

Nutrigation™ via a drip irrigation system

Nutrigation™ is the combined application of water and nutrients to a crop - a mix of fertilization and irrigation. It can be adapted to all types of crops.



ACID HAZARD

When not handled properly, nutrients, acids and chemicals may cause serious injury or even death. They may also damage the crop, the soil, the environment and the irrigation system.

Proper handling of nutrients, acids and chemicals is the responsibility of the grower.

Always observe the nutrient/acid/chemical manufacturer's instructions and the regulations issued by the relevant local authority.

In drip irrigation, the roots are concentrated in a limited soil volume compared to the volume of soil that these roots occupy if the irrigation isn't localized. For this reason, during the irrigation season, relatively small quantities of fertilizers should be applied frequently.

In traditional fertilization methods, some of the fertilizer is applied outside the volume of soil occupied by the roots and thereby wasted.

Advantages

Increased efficiency of fertilizer application

- Fertilizer application with irrigation water provides a better distribution and greater application uniformity.
- The total dose of the applied fertilizers is divided into several smaller portions allowing better retention of the fertilizers in the soil and greater availability.
- Losses due to volatilization are avoided, as with fertilizers containing nitrogen compounds.
- Nutrigation™ permits the application of nutrients according to crop requirements; there is also a possibility of varying the ratio between nutrients during different phenological stages, such as the vegetative stage, flowering, fruit setting, fruit filling and maturation.

Savings in fertilizer and labor

- Due to the conditions of application by irrigation water and the various forms of losses avoided, the amount of fertilizer used to achieve the same production level is reduced.
- Preparation and application of fertilizers in a drip irrigation system cost less compared to the traditional implementation.

Operational advantages

- Health hazards are avoided since workers do not come in contact with the injected fertilizers and chemical.
- Since Nutrigation™ does not require traffic in the field, damage to plants and soil compaction are avoided.
- Nutrigation™ can maintain appropriate nutrient content in soils with low nutrient holding capacity, allowing cultivation in types of soil otherwise not cultivable.
- The contamination of groundwater by elements of fertilizer occurs in many places where flood irrigation is used. Nutrigation™ applies the amount of fertilizer and water in more frequent, smaller portions to prevent runoff or deep percolation.
- There is the possibility of applying other chemicals through the system, such as soil disinfectants, systemic products against crop diseases and pests.

DRIP IRRIGATION MANAGEMENT AND OPERATION

Limitations

- Only water-soluble fertilizers are allowed to be used in drip irrigation.
- Some fertilizers, although water soluble, may not be compatible with the method of Nutrigation™, such as fertilizer that raises the pH of the irrigation water so high that precipitation occurs in the system.
- Certain fertilizers are corrosive to metal parts of the equipment, therefore the parts of the system coming in contact with those fertilizers should be resistant to corrosion.

Characteristics of fertilizers used in Nutrigation™

Knowing the characteristics of the fertilizers to be used in Nutrigation™ is essential for making the right choice of fertilizers and application, to provide the right elements to the plant at the right time.

Chemical composition

Fertilizers can be simple or compound:

- **Simple fertilizers:** are fertilizers that consist of a single product. For example: urea, ammonium nitrate, potassium chloride.
- **Compound fertilizers:** are the products that are obtained by mixing several simple fertilizers, and generally, can be easily seen in the mixture; these are generally not used in Nutrigation™.

Form

- **Solid state:** in this case, the fertilizer may be granulated or powdered.
- **Liquid state:** are fertilizers that can be injected directly into the irrigation system.
Some fertilizers need to be dissolved in water to reduce the concentration prior to injection.

Solubility

Solubility is one of the most important characteristics to be considered in preparing liquid fertilizers. Every fertilizer has a level of solubility, which is influenced by the temperature of the water in which it dissolves.



WARNING

Only water-soluble fertilizers are allowed to be used in drip irrigation.

Some fertilizers are very easy to dissolve in water and others are more difficult, but still can be used in Nutrigation™. There are fertilizers having a solubility level so low that they are classified as water-insoluble and their use in irrigation systems is not allowed, for example, simple and triple superphosphate.

Interaction with irrigation water

Fertilizers are salts that react with other salts found in the irrigation water. Therefore, it is important to consider the chemical composition of the water to be used for preparing the liquid fertilizers. For example, under conditions of high alkalinity water, the phosphorus of a phosphate fertilizer precipitates with calcium and magnesium present in the water. These precipitates can be seen at the bottom of the fertilizer tank.

Interaction between fertilizers

There are fertilizers that are not be mixed on the same mixture, as they are incompatible. In some cases, when mixed, those fertilizers immediately induce crystallization and cause clogging in the irrigation system. In other cases the reaction between two incompatible fertilizers causes the loss of nutritional ingredients to the plant.

DRIP IRRIGATION MANAGEMENT AND OPERATION

Compatibility of the most common soluble fertilizers:

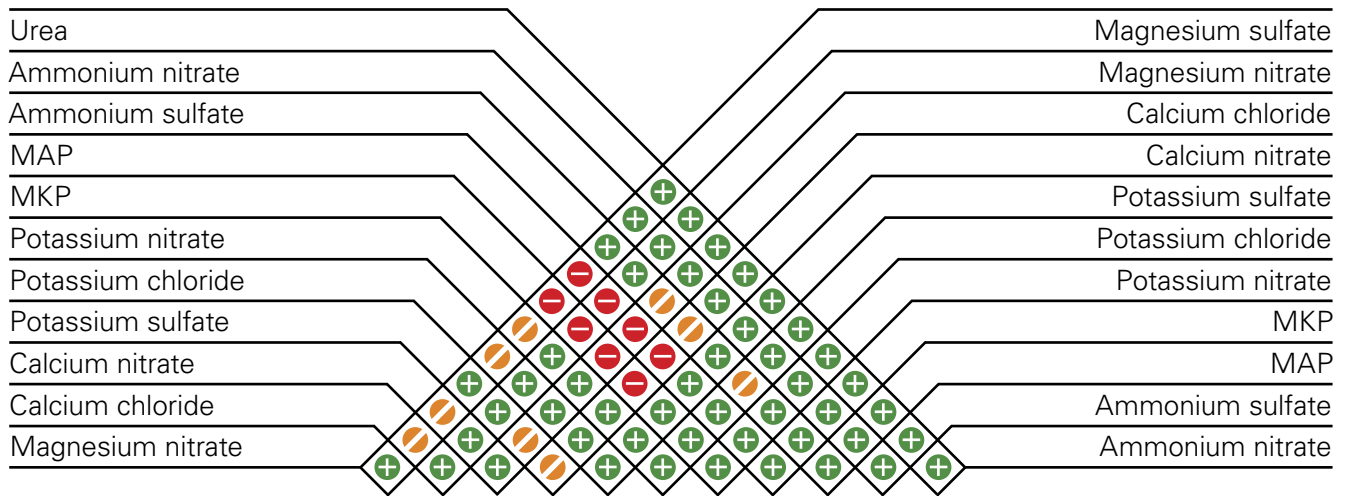

+ Compatible, / Limited compatibility, - Incompatible

Jar test

To avoid injecting products that might clog or otherwise damage the irrigation system, perform the simple jar test described below before injection of fertilizer, acid or any chemical. This is especially important if it is the first time a specific product or mixture of products is used, or when using a product supplied by a new vendor.

To perform the jar test:

- Use a clean, transparent glass container of 2 liters (0.5 gallons) minimum.
- Fill it with the same water used for irrigation, taken at the point of injection in the system.
- Add the product/s to the water in the container at the exact ratio prescribed for injection.
- Manually mix the contents of the container until the products are completely dissolved.
- If the products do not dissolve after mixing for a few minutes, do not inject the product or mixture into the irrigation system and call your local Netafim™ representative for advice.
- If the products dissolve properly, place the container to rest, uncovered, for 24 hours at ambient temperature, protected from direct sunlight.
- After 24 hours, visually examine the contents of the container against the light and check for any type of sedimentation, coagulation or floating solids.
- If any of these are present, do not inject the product or mixture into the irrigation system and call your local Netafim™ representative for advice.

Corrosivity

Most fertilizers, both solid and liquid, attack metals in the irrigation and fertilization systems. Generally, the higher the acidity of the solution, the greater the corrosive effect.

For example: the combination of potassium chloride and phosphoric acid is extremely corrosive.

Volatilization

Fertilizers containing urea and ammonium nitrogen can be lost by volatilization of ammonia. The tanks storing liquid fertilizer mixtures for longer than 4 days must be sealed.

DRIP IRRIGATION MANAGEMENT AND OPERATION

Fertilizer pH

Liquid fertilizers have different pH levels that may affect the crop and the drip irrigation system.

The acceptable pH level for crops is 5 - 7.

The effect of fertilizers with different pH levels on the irrigation system:

pH level		Effect on the irrigation system
up to 5	Acidic	May damage the PC drippers and system components made of materials containing Acetal, depending on the duration of exposure to the substance and the ambient temperature.*
5 - 6	Mildly acidic	When combined with certain nutrients, may damage the PC drippers and system components made of materials containing Acetal, depending on the duration of exposure to the substance and the ambient temperature.*
6 - 8	Neutral	All the components of a Netafim™ drip irrigation system are resistant to pH levels of 6 and up.
8 and up	Basic	When combining certain nutrients, sedimentation might occur, causing clogging of the drippers and other components.*

* Consult a Netafim™ expert.

Salinity

Fertilizers are salts that contribute to the increased salinity of the irrigation water. The level of EC (electrical conductivity) reflects water salinity, and is measured with simple instruments in the field and in laboratory.

Hygroscopicity

Solid fertilizers have the property of adhering to moisture; this stiffens the granules and makes them difficult to handle afterwards. It is important to keep them in a closed container in order to avoid this phenomenon.

Liquid fertilizers

Preparation of liquid fertilizers

The temperature of the water in which it dissolves influences the amount of fertilizer to dissolve, as shown in the following table.

Effect of temperature (°C) on the solubility of fertilizers (fertilizer grams in one liter of water)

Fertilizer grams / liter water	Temperature °C					
	0	5	10	20	25	30
Urea	680	780	850	1060	1200	1330
Ammonium sulfate	700	715	730	750	770	780
Potassium sulfate	70	80	90	110	120	130
Potassium chloride	280	290	310	340	350	370
Potassium nitrate	130	170	210	320	370	460
Mono-ammonium phosphate	227	255	295	374	410	464

It can be observed that the temperature of the fertilizer solution strongly affects fertilizer solubility, as in the case of urea. In contrast, the characteristics of ammonium sulfate are almost not affected by temperature.

Generally, the water temperature, under field conditions, is higher than 20°C. Therefore, it might seem logical to assume that at the time of preparing a liquid fertilizer, that the higher the water temperature, the greater the amount of fertilizer that can be dissolved. But a crucial parameter has been ignored...

DRIP IRRIGATION MANAGEMENT AND OPERATION

When fertilizers are mixed with water, a reaction between the water and the product occurs, which cools the mixture. This is called **endothermic reaction**. Because of the lowered temperature of the water, the entire amount of product calculated according to the original temperature of the water before mixing cannot be dissolved anymore. This occurs with fertilizers containing nitrogen compounds such as ammonium nitrate and urea.



TIP

When dissolving a fertilizer, do not exceed the amount permitted for 10°C, according to the table above.

Choosing the point of injection of liquid fertilizer

The mixture can be injected at various points of the system, according to the need for it.

The fertilizer injected into the irrigation system moves with the irrigation water from the point of injection downstream, therefore, when irrigating, the part of the system downstream from the point of injection will also receive fertilizer.

Three injection points can be listed:

A. In the irrigation head

Fertilizer injected at this location reaches all valves that receive water from the irrigation head.

B. A valve in a specific plot

Fertilizer injected before a specific valve will reach the part of the plot irrigated by the said valve.

C. Between the irrigation head and a group of valves

This is the location between the two points above; it should be used to fertilize a group of valves that irrigate at the same time.

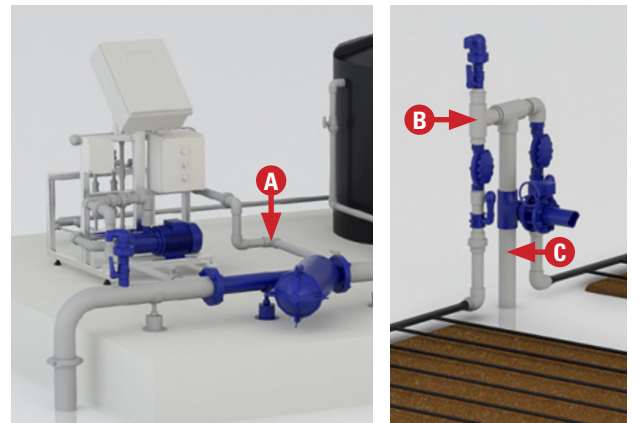

Equipment for liquid fertilizer injection

For the full range of dosing units and how to choose the suitable one, see [Dosing Unit](#), page 26.

Management of drip Nutrigation™

Taking an overview of the irrigation and fertilization program, proceed to analyze whether the program is technically and agronomically acceptable.

First, two important rules must be met:

- The injection of liquid fertilizer will begin only when the irrigation system is fully pressurized and stabilized, that is, when the water has reached the farthest drip line with the required pressure. The duration of fertilizer injection depends on the size and design of the system, but as a general rule it should not in any case be less than 0.5 hours (half an hour).
- Fertilizer injection should not be stopped before the required quantity of fertilizer water exits the farthest dripper. This also depends on the project size, length of the dripperlines and the design of the system. See Advancement Time in the Preventive Maintenance Guide at <http://www.netafim.com/irrigation-products-technical-materials>. If needed, call a Netafim™ expert to calculate fertilizer injection time for your specific system.

Knowing the start time and the end time of fertilizer injection, and the time that fertilization can be performed, proceed according to the calculations and the injection equipment.

Setting the fertilizer application time during irrigation:

The injection time of liquid fertilizer should be determined according to the run time for fertilization to be best exploited, avoiding waste of fertilizer due to water excess, or failure to complete the fertilization program due to irrigation time. **Therefore, a schedule must be made.**

DRIP IRRIGATION MANAGEMENT AND OPERATION

Steps to follow in setting the injection duration and timing

EXAMPLE

A. Calculate the amount of the pure element. Example: Nitrogen

- Quantity of pure nitrogen per month: 50 Kg per hectare.
- Total days in the month: 30 days.
- Quantity of pure nitrogen per day: $50/30 = 1.66$ Kg/ha/day

B. Calculate how many liters of liquid fertilizer will be needed

- For 100 liters of final mixture (water and fertilizer) 20 Kg of urea or ammonium nitrate equivalent, 27.8 Kg are dissolved.
- That amount of urea or ammonium nitrate represents 9 Kg of pure nitrogen ($20 \text{ Kg} * 45\%$, or $27.8 * 33\%$).
- If in 100 liters of liquid fertilizer there are 9 Kg of pure nitrogen, it follows that 1 (one) Kg of pure nitrogen equals 11.1 liters of the mixture ($100/9 = 11.1$).
- Size of the plot to be irrigated: 20 hectares.
- Total injected liquid fertilizer every day will be:
Total hectares * Kg of pure nitrogen in irrigation * liters of fertilizer per Kg of pure nitrogen =
 $20 \text{ ha} * 1.66 \text{ kg N per irrigation} * 11.1 \text{ liters} = 368$ liters of fertilizer per irrigation.
- Irrigated every two days; therefore 736 liters ($368 * 2$) must be applied.

C. Required duration of irrigation

- Calculated hourly irrigation capacity of the system:
 - The dripper flow is 0.8 liters per hour.
 - The distance between drippers is 0.50 meters.
 - The distance between the dripperlines is 1.60 meters.
 - The hourly capacity irrigation is $= 0.8 / (0.5 * 1.6) = 1.0$ mm per hour or 10.0 m^3 per hectare per hour.
- Daily evaporation tank as Class "A" is 8 mm.
- Replacement coefficient (Kc) = 0.8
- Amount of water to irrigate per day $= 8 \text{ mm} * 0.8 = 6.4 \text{ mm}$ or 64 m^3 per hectare.
- Run time per day $= \text{Total water to irrigate in mm} / \text{irrigation Hourly capacity in mm} / \text{hour} =$
 $6.4 \text{ mm} / 1.0 \text{ mm per hour} = 6$ hours 24 minutes.
- However, as it is irrigated every other day, irrigate duration should be set for 12 hours and 48 minutes.

D. Required injection time

- In this example, the fertilizer injector is capable of injecting 100 liters per hour.
- Total fertilizer to be injected is 736 liters (step B).
- Time to be injected: $736 \text{ liters fertilizer} / 100 \text{ liters per hour} = 7.36$ hours (7 hours and 22 minutes).

E. Injection program

Having calculated all the above data, the next step is to decide the timing of fertilizer injection during irrigation.

Proposed program:

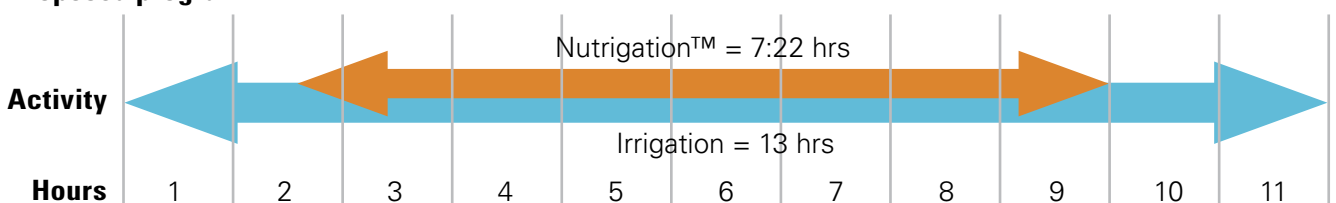

DRIP IRRIGATION MANAGEMENT AND OPERATION

Nutrigation™ in the rainy season

It may happen that, after a rainfall, fertilization should be performed, applying the amount of fertilizer that could not be applied during the days without irrigation. For this purpose the liquid fertilizer mixture may be modified by concentrating more for the same amount of nitrogen.

EXAMPLE

If you must fertilize to complete the dose of 4 days, but with an amount of water equivalent to 1 (one) day of watering, you can proceed as follows:

- Amount of water: 6.4 mm
- Run time: 6 hours 24 minutes
- Nitrogen dose per day: 1.66 Kg per hectare.
- Replenish fertilization days: 4 days.
- In the liquid fertilizer tank, fertilizer can be prepared in either of the following ways:
 - At the same concentration, which means that in 11 liters of the mixture there is 1 Kg of pure nitrogen.
 - Increasing the amount of urea, for example, add 30 Kg of urea-equivalent, 13.5 Kg ($30 \times 0.45 = 13.5$) pure nitrogen into the 100 liters mixture. This means one (1) Kg of nitrogen to 7.4 liters of liquid fertilizer.
- If the project size is 20 hectares, the injection quantity depends on whether it continues with the same concentration of nitrogen in the tank or is increased, as explained in the previous section.
Then:
 - $1.66 \text{ kg N/day} \times 20 \text{ hectares} \times 11 \text{ l/kg N} \times 4 \text{ days} = 1461 \text{ liters.}$
 - $1.66 \text{ kg N/day} \times 20 \text{ hectares} \times 7.4 \text{ l/kg N} \times 4 \text{ days} = 982 \text{ liters.}$
- The injection time can be 4 to 5 hours, which would require modifying the flow of the fertilizer injector, according to the following calculation:
 - $1461 \text{ liters} / 4 \text{ hours} = 365 \text{ liters per hour.}$
 - $1461 \text{ liters} / 5 \text{ hours} = 293 \text{ liters per hour.}$
 - $982 \text{ liters} / 4 \text{ hours} = 245 \text{ liters per hour.}$
 - $982 \text{ liters} / 5 \text{ hours} = 196 \text{ liters per hour.}$

Choose the option that fits the system's capacities and the soil moisture, and allows irrigation with acceptable electrical conductivity (EC).

Chemigation

Chemigation™ refers to injection of chemicals to prevent or reduce dripper clogging (addition of chlorine, hydrogen-peroxide, acid or others), and the injection of chemicals for crop and soil concerns (herbicides, pesticides and others).



WARNING

When not handled properly, nutrients, acids and chemicals may cause serious injury or even death. They may also damage the crop, the soil, the environment and the irrigation system.

Proper handling of nutrients, acids and chemicals is the responsibility of the grower.

Always observe the nutrient/acid/chemical manufacturer's instructions and the regulations issued by the relevant local authority.

DRIP IRRIGATION MANAGEMENT AND OPERATION



NOTE

Netafim™ authorizes the use of certain chemical agents. Products that are not authorized in this summary must pass a control test in Netafim's laboratory prior to being utilized, to ascertain if they are safe for use with Netafim's systems.

Fungicides, herbicides, insecticides and disinfectants authorized by Netafim™

- Metam sodium
- Telone II
- Formaldehyde

There are additional options; contact the Agronomy Division of Netafim™ for details.

After chemigation it is necessary to continue irrigation with water that is free of chemical products. Verify the flushing duration and timing with the tables showing the advancement times (see the dripperline's Technical Datasheet).

In irrigation systems with anti-drainage drippers (CNL), in addition to the previous instruction, it is necessary to open the ends of the dripperlines for flushing.

Possible product issues

In general, products, both those approved and not approved by Netafim™, contain approximately the same percentage of active material. The differences between the various products are:

- The quality of the product
- The dosage
- The storage time
- The quality of the emulsion

With good-quality emulsion, the active components in the product mix with the water without creating layers of different compositions. When these conditions are not fulfilled, the contact of high concentrations of the product's active ingredients with various parts of the system, such as valves, drippers, flow meters, etc., could damage them. These products are very corrosive to some metals and also react with various polymers (depending on the product).

Applying herbicide by chemigation via drip irrigation

Chemigation is done by a dosing unit. For the full range of dosing units and how to choose the suitable one, see [Dosing Unit](#), page 26.

Advantages

- Avoids crop damage and contamination of foliage, flowers and fruits caused by spraying.
- Application is local and avoids damaging the neighboring crops.

Herbicide injection process

- Herbicide should be diluted to obtain an aqueous solution prior to injection.
- Inject herbicide into the system at the head of the relevant plot.
- Start the injection of herbicide only after half, but before two-thirds of the planned irrigation time, based on the advancement time, has elapsed, in order to ensure that the whole quantity of injected herbicide has been evacuated from the system through the drippers.
- After injection of the required amount of herbicide, irrigation should be continued for at least 15 minutes in order to flush herbicide residues out of the system.



TIP

The herbicide injection should take place towards the end of the irrigation event.

Example: if you plan to irrigate 300 m³/ha water, the herbicide will be applied once a quantity of approximately 250 m³ has been irrigated.

DRIP IRRIGATION MANAGEMENT AND OPERATION

Dripperline insertion or laying

It is important to lay or insert the dripperlines with the drippers facing upwards. This prevents sediments present in the dripperlines from penetrating the drippers and extends the life of the dripperlines.



NOTE

When inserting or laying thick-walled dripperlines, it is impossible to ensure that the drippers will uniformly face upwards.

When inserting dripperlines, a **Netafim™ Roller Box** with Okolon rollers must be installed on the insertion machine to straighten the dripperlines in order to prevent their bending, ensuring that drippers always face upwards.



NOTE

Bends in the dripperline interfere with the regular flow of water and might block the passage of water down the dripperline.

Use Netafim's dedicated insertion shank

- Diameter: 1.5".
- Seamless, schedule 40 steel pipe, without any inner protrusions that might damage the dripperlines.
- Conic pipe inlet to allow smooth feeding of the dripperline throughout the entire deployment of the dripperline from the reel.
- Allows deep insertion while ensuring that the shank's inlet is above ground level to prevent soil from entering the shank's pipe.
- The shank's outlet is beveled to ensure smooth emission of the dripperline without damaging the drippers.



The dripperline reel must be installed so that it rotates in the opposite direction to the tractor's movement as indicated by the arrow on the side of the reel. This way the dripperline enters the conic pipe inlet of the shank at a correct angle.

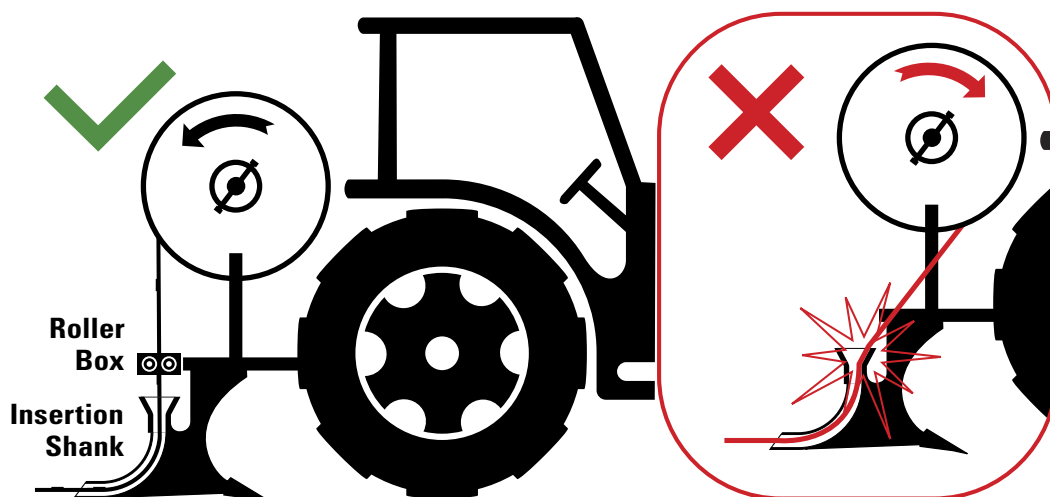

WARNING

Installing the dripperline reel the wrong way will result in damaging the drippers while they enter the conic pipe at a too steep angle.

See an overview of [Netafim's agro-machinery for dripperline insertion, laying and retrieving](#) on page 44.

For further information about agro-machinery see the Agro-Machinery Catalog at <http://www.netafim.com/irrigation-products-technical-materials> or call your local Netafim™ representative.

DRIP IRRIGATION

SYSTEM

MAINTENANCE

Maintenance timetable	67
System flushing	68
Preparation and use of a hydraulic conditions checklist	75
Chemical injection for system maintenance	76
Water analysis	77
Sampling drippers	79
Rodent control	80
Root intrusion prevention in subsurface drip irrigation (SDI) systems	81
Contamination from external particles in SDI	81
Periods of system inactivity	82

DRIP IRRIGATION SYSTEM MAINTENANCE

The aim of this chapter is to provide guidelines and useful tips for the proper maintenance of a drip irrigation system.



NOTE

For the correct operation of the irrigation system it is imperative to implement all the instructions for proper maintenance of the drip irrigation system in this chapter.

For optimal performance, drip irrigation systems require routine system maintenance. Even though recent innovations in dripper design have made clog-resistant dripperlines readily available, the nature of agricultural water sources, nutrient injection practices, natural limitations of filtration equipment and the general agricultural growing environment make maintenance a priority.



WARNING

In extreme cases of negligence to perform routine system maintenance, a clogged drip irrigation system might cause the loss of the current crop and even necessitate replacement of the dripperlines.

Taking baseline readings and monitoring flow, pressure and the condition of flush water regularly will provide guidance for maintenance scheduling.

In addition to flow, pressure and condition of flush water, the overall condition of the pump station and distribution system should be routinely inspected and/or calibrated including control equipment engines, motors, reservoirs, injectors, pipelines, valves, fittings, flow meters and pressure gauges.

Broken or dysfunctional equipment should be immediately repaired or replaced with the same or similar equipment that will perform the same function according to system design criteria.

Aside from making equipment adjustments or repairs, the majority of system maintenance activities are: applying chemicals, flushing the system and controlling pests.

Maintenance consists of two categories:

- **Preventive maintenance**, aimed at preventing clogging of the drippers, can be divided in three categories:
 - Flushing the system
 - Chemical injection
 - Irrigation scheduling*
- **Corrective maintenance** consists mainly of removal of obstructions already present in the drippers:
 - Flushing the systemAnd one or more of the following practices according to the nature of the obstruction:
 - Organic formation - treated with hydrogen peroxide.
 - Mineral sedimentation - treated with acids (or a combination of acid and hydrogen peroxide).
 - Organic formation and mineral sedimentation - treated with a combination of acid and hydrogen peroxide.

DRIP IRRIGATION SYSTEM MAINTENANCE

Maintenance timetable

When operating a new system for the first time

- Flush the piping - main line, sub-mains and distribution pipes.
- Flush the dripperlines.
- Check actual flow rate and working pressure for each irrigation shift (when the system is active for at least half an hour).
- Compare the data collected to the data supplied with the system (planned). The tolerance should not be greater than $\pm 5\%$.
- Write down the newly acquired data and keep it as benchmark for future reference.
- If the flow rate and/or the working pressure at any point in the system differ by more than 5% from the data supplied with the system, have the installer check the system for faults.

Once a week

- Check actual flow rate and working pressure for each irrigation shift under regular operating conditions (i.e., when the system is active for at least half an hour and stabilized).
- Compare the data collected to the benchmark data.
- Check that the water reaches the ends of all the dripperlines.
- Check the pressure differential across the filters.
A well-planned filtration system should lose 0.2 - 0.3 bar (when the filtration system is clean).
If the pressure differential exceeds 0.8 bar (11.6 PSI), check the filter/s and their controller for faults.

Once a month

- Check the pump's flow rate and pressure at its outlet.
- Flush the dripperlines.
(A higher or lower frequency may be required, depending on the type and quality of the water.)
- If the filtration system is automatic, initiate flushing of the filter/s and check that all the components work as planned.
- If pressure-regulating valves are installed, check the pressure at the outlet of each one of them and compare these figures with the benchmark data.

Once a growing season

In some cases the following need to be performed twice or three times in a growing season, depending on the type and quality of the water used.

- Check all the valves in the system.
- Check the level of dirt in the system (carbonates, algae and salt sedimentation).
- Check for occurrence of dripper clogging.
- Flush the piping - main line, sub-mains and distribution pipes.
- If necessary, inject hydrogen peroxide and/or acids as required.

At the end of the growing season

- Inject chemicals for the maintenance and flushing of the main line, the sub-main lines, the distribution pipes and the dripperlines.
- Flush the dripperlines.
- Prepare the system for the inactive period between the growing seasons.
- Perform winterization of the system in regions where the temperature might drop below 0°C (32°F).

DRIP IRRIGATION SYSTEM MAINTENANCE

System flushing

Flushing the irrigation system reduces to a minimum the accumulation of pollutants, pushing them out of the system.

Flushing of the irrigation system is comprised of 3 processes:

- Filter back-flushing
- Flushing main and sub-main lines
- Flushing dripperlines

Filter back-flushing



ATTENTION

For effective filtration, filters must be back-flushed whenever they become dirty.

Filters - whether disc, screen or media (see [Types of filters](#), page 17) - should be back-flushed periodically to clear out any collected particulate or organic matter. Clogged filters can reduce pressure to the system, lowering the water application rate.

The filter's performance depends on the efficiency of its flushing and cleaning. Any accumulation of non-disposed material will eventually lead either to clogging of the filter or, in a gravel/sand filter, to the release of the filtering material along with the filtered water during migration.

When designing a filtration system, filter flushing must be considered. Most filtration systems are designed for either manual, semi-automatic or automatic flushing. Flush cycles for manual and semi-automatic systems are manually activated, while flush cycles for automatic systems are activated either when a pre-set pressure differential across the filters is exceeded, or by a pre-set operational time interval. Selection of filtration automation depends upon cost and labor considerations.

Flowing water or well water usually requires a sand separator to remove sand before it enters the filtration system (see [Hydrocyclone Sand Separator](#), page 17).

Pressure differential across a filter

Every filter must cause a loss of pressure in the system while filtering. This loss of pressure is demonstrated by the pressure differential across the filter (between the inlet and the outlet of the filter / filtration array).



NOTE

Check the filter documentation for the allowable pressure differential across the filters.

Most filters are subject to an increasingly higher pressure differential between inlet and outlet due to friction as the filter becomes clogged. Monitor the filter pressure differential frequently, especially as water conditions change in the course of the season.

Check the pressure differential across the filter (according to the filter documentation)

Filter	Higher than the maximum	Lower than the minimum
Gravel/sand	Partial or total clogging of medium	Tunnels in the medium or breakage and loss of medium
Screen	Screen clogging	Screen ripping or bursts through the screen (meat grinder)
Disc	Clogging of filtration grooves	Leakage through discs due to solids trapped between the discs (preventing the discs from being pressed close together and causing gaps in the disc array)

A pressure differential that is higher or lower than the recommended range for the specific filter may lead to debris passing through the filters and/or poor irrigation system performance.

DRIP IRRIGATION SYSTEM MAINTENANCE



ATTENTION

Too frequent automatic flushing occurs when the filter is not properly cleaned and the pressure differential across the filter remains high immediately after flushing.

Visual inspection

Visually inspect the filtration unit or medium and all other filter components and accessories for mechanical integrity.

Automatic flushing

Check the frequency of automatic flushing

Flushing frequency is too high	Flushing frequency is too low	Automatic flushing is not triggered
<ul style="list-style-type: none"> The filtration unit or medium remains clogged after flushing. The pressure range is incorrectly set in the controller. Faults in automation or sensor. 	<ul style="list-style-type: none"> The filtration unit or medium is breached or leaking. Faults in automation or sensor. Mechanical failure. 	<ul style="list-style-type: none"> Faults in automation or sensor. Mechanical failure.

Once a month

If the filtration system is automatic, initiate flushing of the filter/s and check that all the components work as planned.

Gravel/sand filter

Check the water at the filter's drainage exit by touch to detect loss of gravel/sand medium.

Filter flushing techniques

Many filter systems are automated and will self-clean via an electric or hydraulic 3-way back-flush valve when a pre-set filter differential is reached. For this procedure, the water flow is reversed for a short time to carry away debris through a back-flush line.



ATTENTION

To prevent loss of nutrients, if a filter is installed downstream from a dosing unit, set the controller to pause Nutrigation™ or chemigation during filter back-flushing. Always give priority to filter back-flushing. Do not perform Nutrigation™ or chemigation during filter back-flushing.

Each type of filter has a different flushing mechanism

The typical flushing mechanism of each type of filter is described below. However, for flushing a specific filter, always refer to its user manual.

Screen filter

Flushing is performed during the filter's current operation.

The automatic valve opens the drainage outlet, which creates suction in the flushing axis.

The motor rotates the flushing axis and moves it back and forth, drawing the dirt from the entire inside surface of the filtration screen.

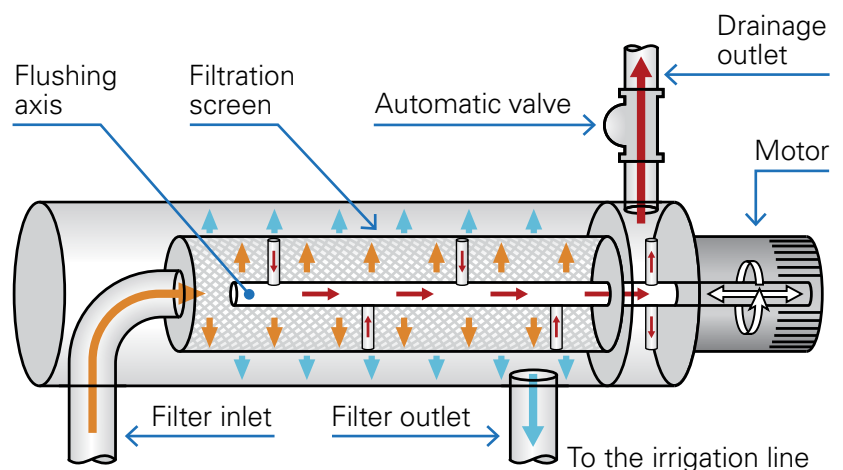

DRIP IRRIGATION SYSTEM MAINTENANCE

Disc filter

During current operation, the piston at the top of all the filters in the array holds the discs pressed close together.

All the automatic inlet valves are open and the drainage valves are close.

Water flows through the disks into the irrigation line.

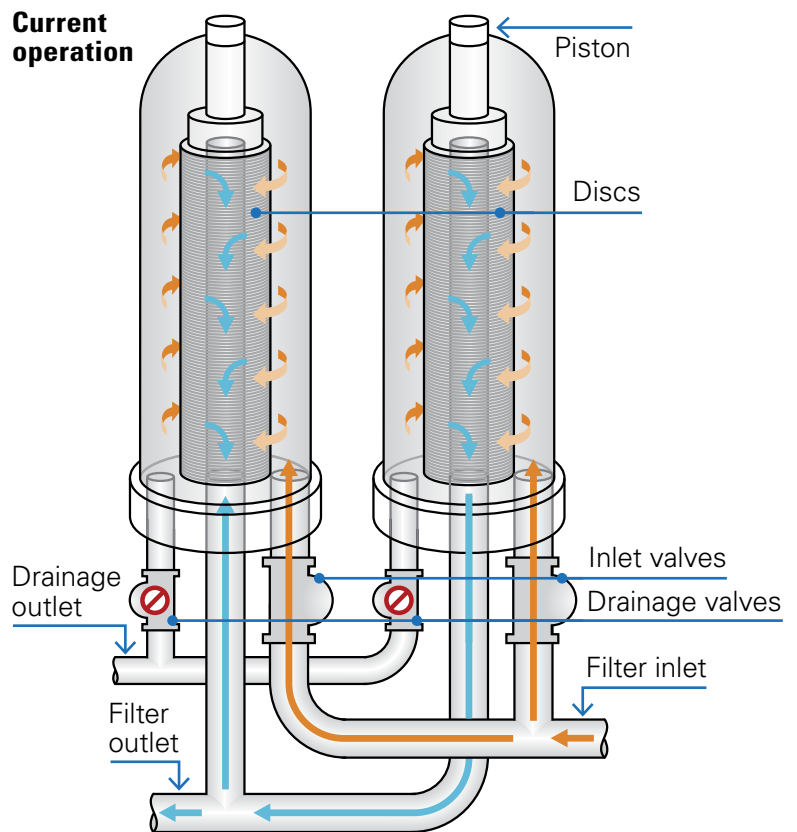

During the flushing operation, the piston at the top of one of the filters in the array spreads the discs to allow the water flowing between them to pick up the dirt from the grooves in the discs.

The automatic inlet valve is close and the drainage valve is open.

The opened drainage outlet creates a pressure differential across the filter, allowing water to flow into the filter through its outlet and out of the drainage outlet, back-flushing the filter discs.

Filters in an array are flushed in sequence.

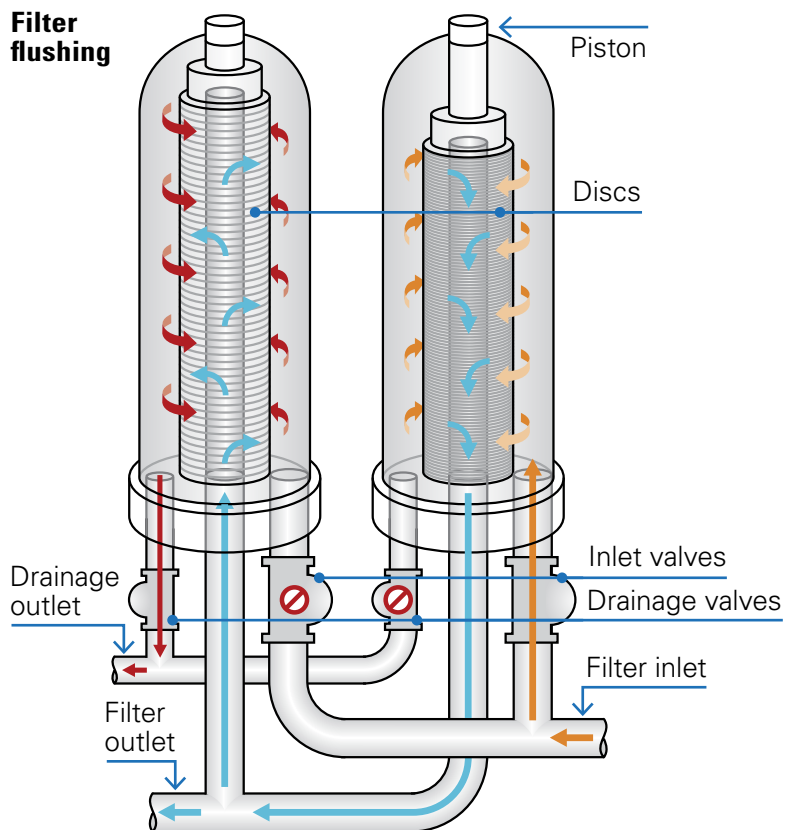

DRIP IRRIGATION SYSTEM MAINTENANCE

Gravel/sand filter

During current operation, the automatic 3-way valves close the filter's drainage outlets. Water flows through the gravel/sand medium into the irrigation line.

When filter flushing is performed, the automatic 3-way valve of one of the filters opens the drainage outlet while blocking the water inlet to the filter.

The opened drainage outlet creates a pressure differential across the filter, allowing water to flow into the filter through its outlet and out of the drainage outlet, back-flushing the filter's gravel/sand medium.

Filters in an array are flushed in sequence.

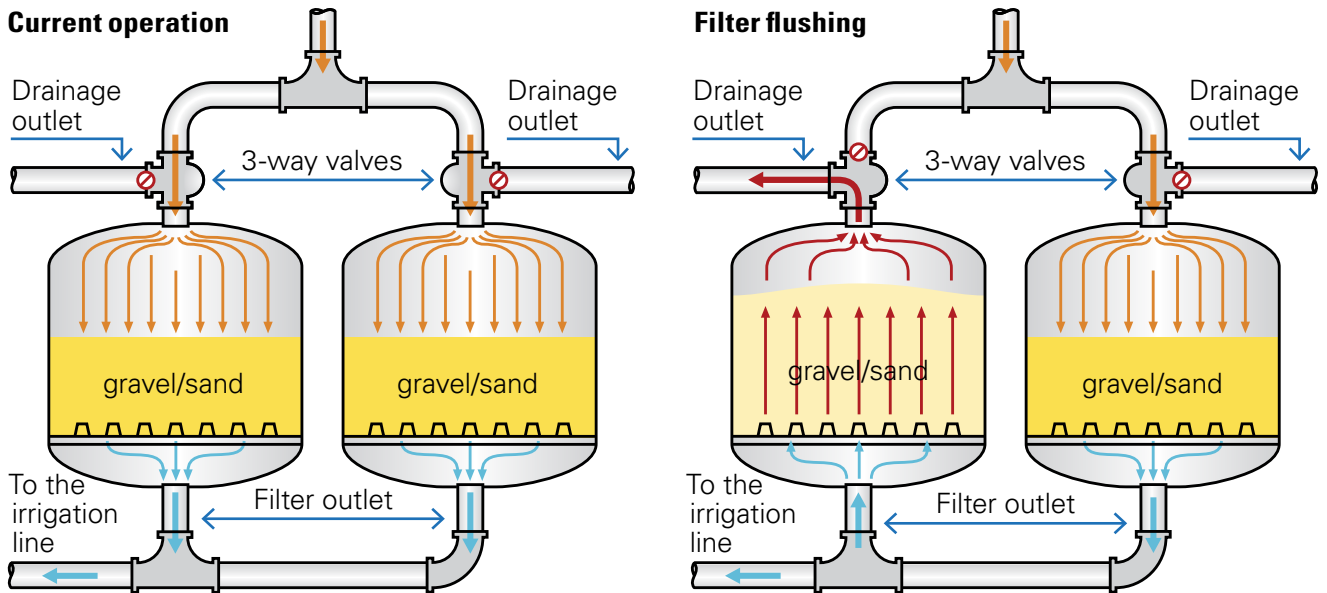

Hydrocyclone sand separator

To flush the sand accumulated in the sand compartment at the bottom of the hydrocyclone sand separator, open the valve at the drainage outlet of the filter.

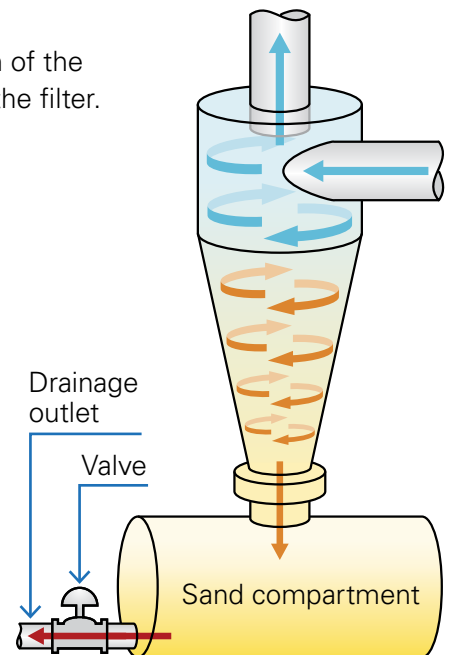

DRIP IRRIGATION SYSTEM MAINTENANCE

Periodic filter maintenance



CAUTION

Before starting filter maintenance, make sure the system is not under pressure.

Gravel/sand filter

Periodic inspection of the medium in gravel/sand filters is an essential maintenance task that is frequently neglected. Gravel/sand should not be caking and cracking and should be adequately cleaned during the automatic back-flush cycles.

The filter might lose some gravel/sand during the back-flush cycles, so even if the filter is in proper working order, it may require additional gravel/sand from time to time.

During inspection examine the gravel/sand by touch. The gravel/sand grains should be sharp edged, not rounded smooth like beach sand. The sharp edges promote better filtration but backwash cycles will wear the gravel/sand smooth over time. If this has occurred, replace the gravel/sand. The rounding of gravel/sand edges may take a number of years, but it will eventually happen.

Screen filter

- Take the screen out of the filter casing and clean it with pressurized water and brushes.
- Visually inspect the screen for breaches and cracks and replace the screen if damaged.

Disc filter

- Open the filter's casing and release the piston holding the discs pressed close together.
- Take the discs out of the filter casing.
- Thread the discs on an acid-resistant rope and tie the ends of the rope to form a loop. Do not thread too many discs on one loop; it is important that the cleaning solution reaches all the disc surfaces.
- Soak the discs in this solution,* making sure the discs are loose and have good contact on both sides with the solution. Do not put too many discs in at one time.
- If the disk remains dirty repeat the last step.

***solution for surface water with organic and biological residue:**

Make a 10% peroxide solution. Pour 7 liters (1.8 gallons) of water into a container and add 3 liters (0.8 gallons) of hydrogen peroxide (35%) or pour 8 liters (2.1 gallons) of water into the container and add 2 liters (0.53 gallons) of hydrogen peroxide (50%) to the water.

***solution for well water with manganese, iron or carbonate deposits:**

Make a 10% hydrochloric acid solution. Pour 7 liters (1.8 gallons) of water into a container and add 3 liters (0.8 gallons) hydrochloric acid (30-35%) to the water.

- Stir the discs in the solution a few times. Total soaking time should be 1 to 3 hours.
- If the solution is no longer cleaning the discs, replace it with a new mixture.
- Visually inspect the discs for cleanliness and for dents and cracks and replace any damaged discs.
- Rinse the discs with clean water.
- Put the discs back in the filter. Make sure to put back the same number of discs that have been taken out. Tighten the piston holding the discs pressed close together and close the filter casing.
- Flush the filter a few times to remove all chemicals.

DRIP IRRIGATION SYSTEM MAINTENANCE

Flushing the main, sub-main and distribution lines

Flushing the main, sub-main and distribution lines is an important operation that often doesn't get the attention it requires. Even with a primary filter at the head control station, small particles can get by and should be physically removed from the piping system.

Flushing the main, sub-main and distribution lines will considerably reduce the accumulation of organic and mineral materials in the system. This will prevent those materials from reaching the drippers and eventually clogging them, thus minimizing the quantity of chemical products required to maintain the system. Regular flushing of the main, sub-main and distribution lines will result in a significant saving of labor time and chemicals.

The main, sub-main and distribution lines in the system should be flushed in sequence. Each one of them should be flushed for at least two minutes or until the flushed water runs clear.



ATTENTION

The pipes must be flushed at regular intervals. The frequency depends mainly on the water quality and the maintenance program (minimum: once a growing season).

Flushing is effective only when the flow rate within the main, sub-main or distribution line is sufficient to allow for proper flushing velocities in the system.

Manual flushing of main, sub-main and distribution lines

Flushing may be automatic or manual.

Manual flushing of main, sub-main and distribution lines should be carried out as follows:

- Flush the pipes in this order: main line, sub-main lines, distribution lines.
- Open the flushing valves of each one of them in turn while under pressure.

The process of flushing the main, sub-main and distribution lines consists of two waves for each:

- The first wave removes contaminants collected at the end of the pipe.
- The second wave removes contaminants from the pipe.

The color of the water is not as dark as in the first wave, but the process takes more time.

Flushing must be continued until the water is visually clean.

Obtain the velocity of the water flowing in the pipes

The velocity of the water in a pipe depends on the flow rate and the internal diameter of the pipe.

- Identify the diameter of each pipe section to be flushed separately using the table below, presenting the most common diameters of pipes used for main, sub-main and distribution lines:

Nominal pipe diameter - Inch (mm)	3 (75)	4 (110)	6 (160)	8 (225)	10 (250)
Actual internal pipe diameter - mm	67.8	101.6	147.6	207.8	230.8

- Check the flow rate in each pipe section to be flushed separately with the closest water meter installed upstream from it.
- Knowing the diameter of the pipe and the flow rate, use the graph below to derive the velocity for each pipe section to be flushed. The recommended flushing velocity is 1.5 m/sec (5 ft/sec). The allowable velocity range for flushing is 1.0-2.0 m/sec (3.3-6.6 ft/sec).

DRIP IRRIGATION SYSTEM MAINTENANCE

Velocities in pipes of various diameters at various flow rates*

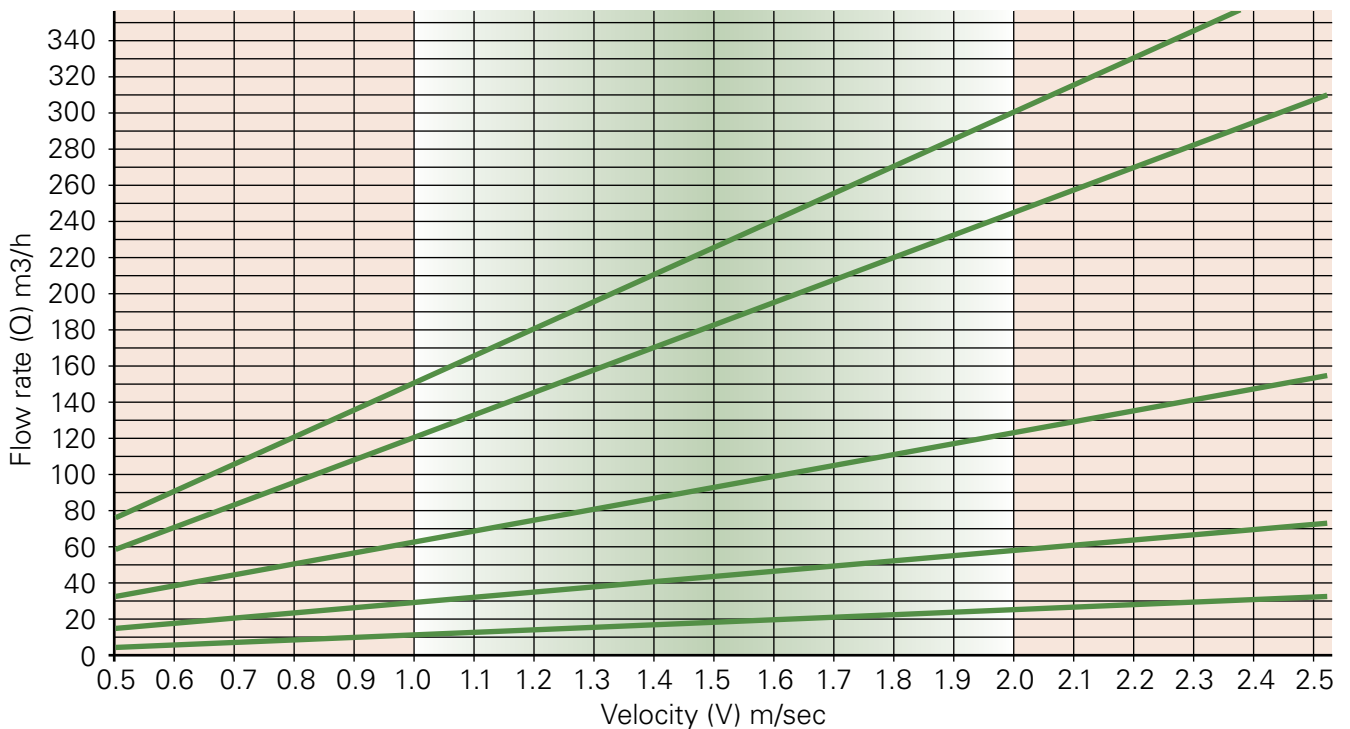

* The graph represents the velocities in pipes of one specific standard among many. If the pipe used in the system's main, sub-main or distribution lines does not appear in the above table and graph, call your local Netafim™ representative.

Flushing the dripperlines

Dripperlines in both surface and SDI systems require periodic flushing to purge them of settled debris, organic or mineral, and of any residues of chemicals injected into the system.

In SDI systems, dripperline flushing must be given high priority since frequent dripperline replacement is impractical and dripperlines are expected to last up to 20 years or even longer. Even for short-term dripperline use, flushing is important to maintain irrigation uniformity.

Flushing should be performed as often as needed to keep the dripperlines clean; this depends on seasonal water quality and the effectiveness of the system filter.

All the dripperlines in a plot should be flushed in sequence in a single flushing event.

Dripperlines should be flushed until the flushed water runs clear.

Flushed water should be disposed of properly to avoid deteriorating the system's inlet water quality and/or the quality of the environment surrounding the site.



CAUTION

Flushing will temporarily increase the flow requirements of the system, which in turn will decrease the system pressure. In some cases, in order to supply the flow rate required for flushing, an additional pump at the head of the system is used. The additional pump will be activated only during flushing to add the missing flow rate.

The length of dripperlines affects the required flushing duration. Longer dripperlines need longer flushing durations.

DRIP IRRIGATION SYSTEM MAINTENANCE

Visual inspection of water quality

As often as each irrigation, the ends of dripperlines should be opened and the contents emptied into a jar for visual inspection of water quality. System maintenance should be performed as soon as water quality begins to degrade, as shown by color, grit, organic or any solid materials in the flush water.

Verification of the flow velocity in the dripperline during flushing

Place the open end of the dripperline over a 1.5-liter bottle, using a funnel. Verify that all the water enters the bottle. Measure the time (in seconds) it takes to fill the bottle, and use the following table in order to make sure that the velocity is at least 0.5 m/sec (1.65 ft/sec).

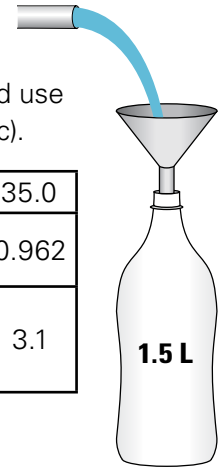

Dripperline ID (mm)	11.8	14.2	16.2	17.5	20.8	22.2	25.0	35.0
Quantity of water per 1 meter of dripperline length (liters)	0.109	0.158	0.206	0.241	0.340	0.387	0.491	0.962
Maximum time for filling of bottle (seconds) for a velocity of at least 0.5 m/sec (1.65 ft/sec)	27.4	18.9	14.6	12.5	8.8	7.8	6.1	3.1

The dripperline flushing process consists of two waves:

- The first wave removes contaminants collected at the end of the dripperline.
- The second wave removes contaminants from the dripperline.

The color of the water is not as dark as in the first wave, but the process takes more time. Flushing must be continued until the water is visually clean

Netafim™ dripperlines - maximum flushing pressure:

For [dripperline characteristics](#) see tables on page 35.



NOTE

The maximum allowed flushing pressures in the tables on the previous page are valid when flushing for a maximum of half an hour consecutively, with the end of 5 or more dripperlines kept open. To avoid exceeding the allowable pressure in the system, a minimum of 5 dripperlines should be open at any time during flushing.

Preparation and use of a hydraulic conditions checklist

Keeping track of the system's hydraulic conditions - flow rate and pressure, is of utmost importance for the detection of malfunction, clogging and leaks in the system.

Prepare a hydraulic conditions checklist (in the form of a table) representing the flow rate and pressure at the head of the system and at the head of each plot.

Fill in the table's first row with the system's planned data received from Netafim™.

Fill in the table's second row with the benchmark data recorded at the time of initial operation of the system (record the data after the system's flow rate and pressure are stabilized).

The benchmark data should not deviate from the planned data by more than $\pm 5\%$.

If a deviation greater than $\pm 5\%$ is recorded at any point in the system, call your local Netafim™ representative.

Fill in the following rows with the actual data recorded each time the system is checked during regular operation according to the [maintenance timetable](#) (see page 67).

If a deviation greater than $\pm 5\%$ is recorded at any point in the system, troubleshoot the problem and record the hydraulic conditions again after troubleshooting.

DRIP IRRIGATION SYSTEM MAINTENANCE

If, at any point in the system, hydraulic conditions within $\pm 5\%$ deviation of the benchmark data cannot be restored, call your local Netafim™ representative.

The hydraulic conditions checklist should be filled in regularly and kept for future reference.

Chemical injection for system maintenance

The injection of different treatments may prevent, eliminate, dissolve or solve occurrences of clogging.

The following flow chart is a guide for determining the order in which to perform chemical injection:

1. Begin by recording the system's flow rate at operating level.
2. Calculate the dose to be injected, based on the recommendations in the Preventive Maintenance Guide at <http://www.netafim.com/irrigation-products-technical-materials>.
3. Perform a test injection, in order to verify and/or rectify the correct functioning and the respective flow rate of the injection system.
4. Flush the system according to the instructions in the section [System flushing](#), page 68.
5. Inject the chemical calculated in step 2 above, depending on the specific treatment.
6. Flush the system, taking into account the advancement times (see the dripperline's Technical Datasheet).

Removal of chemical residues from the system

Upon completing the injection of products (fertilizers, disinfectants, oxidants, herbicides, etc.) continue irrigating only with water for as long as necessary to remove all residue of these products from the system.

Hydrogen peroxide (H₂O₂) treatment

Hydrogen peroxide is used for disinfecting and oxidizing the irrigation water, for cleaning screen, disc and gravel/sand filters, and as an oxidizing agent for fruits and vegetables prior to storage.

Hydrogen peroxide is a strong oxidizing agent. It releases oxygen atoms that react quickly, oxidizing organic matter (also suitable for oxidizing iron and manganese). It decomposes in an exothermic reaction (a chemical reaction that releases energy in the form of heat) into water and gaseous oxygen.



WARNING

Hydrogen peroxide (H₂O₂) is toxic and dangerous for humans.

Before using hydrogen peroxide, read all the instructions for hydrogen peroxide treatments, the local legal regulations and the manufacturer's instructions.

Advantages of hydrogen peroxide

• Environment friendly

Does not contaminate the soil, is biodegradable, does not harm the aquifer, does not generate dangerous by-products and indirectly makes more oxygen available for the soil and the plants.

• Quick oxidation reaction

Consumed immediately upon contact with the irrigation water. Suitable for quick oxidation and disinfection of the water source (also in close proximity to filters).

Hydrogen peroxide is commonly used in greenhouses, net houses and tunnels, or on substrates, where the irrigation systems traverse only short distances.

DRIP IRRIGATION SYSTEM MAINTENANCE



WARNING

Never perform chemical treatment(s) while plants are actively growing in an artificial growing medium or limited root zone.

The required concentration of hydrogen peroxide at the system inlet depends on the water quality (oxidation potential and the reduction and concentration of organic matter in the water). In general, between 1 and 10 PPM (parts per million) of hydrogen peroxide (active agent) are required.

Uses of hydrogen peroxide

- Prevent the accumulation of bacterial slime in the sub-main pipes and dripperlines.
- Clean irrigation systems of accumulated organic deposits and bacterial slime.
- Oxidize micro-elements (such as iron and sulfur) and trace elements (such as manganese), and prevent bacterial propagation.
- Improve the main and secondary filtration under high organic load conditions.
- Disinfect and treat irrigation water, waste water, sewage, drinking water and swimming pools.
- Prevent and eliminate water odors and interference with biological activity.
- Reduce BOD/COD values by oxidizing organic and inorganic polluting materials.

See instructions and calculation for hydrogen peroxide injection in the Preventive Maintenance Guide at <http://www.netafim.com/irrigation-products-technical-materials>.

Water analysis

Analyze the water used in the irrigation system and determine its quality.

The water quality refers to the concentration of chemical substances dissolved and suspended in the water, as well as the physical and biological properties of the water.

A water analysis is necessary in order to select an appropriate type of filtration system, to prescribe a suitable maintenance program, to select the type of dripperlines and to prescribe an appropriate Nutrigation™ plan.

For agriculture, water quality is defined according to the following criteria:

- Agronomic water quality - the extent to which it is compatible with the type of soil and with the crop.
- Water quality for irrigation - the extent to which it induces clogging of the irrigation system.

The source of water may be: potable water, waste water, residual water, wells, reservoirs, canals or drainage water. Each one requires different levels of treatment before being used.

It is recommended to analyze the irrigation water at least once a growing season and, if needed, in the course of the growing season, considering meteorological and environmental factors that potentially influence the water quality. Consult Netafim's Agronomy Division (especially recommended for new projects).

Water quality is not controllable; it varies with time for a variety of reasons. This means that different treatments are required at different times in order to ensure that water quality is suitable for the irrigation system.

Therefore, it is recommended to analyze the water occasionally in order to constantly adjust the treatment.

Other factors that affect the water quality and must be taken into account are the fertilizers and chemical products used in the same system for various treatments.

DRIP IRRIGATION SYSTEM MAINTENANCE

Taking water samples:

1. Before taking a water sample, flush a clean one-liter bottle, using water from the source to be sampled.
2. Fill the bottle so that no air at all remains inside the bottle (if possible, squeeze the bottle to expel any remaining air).
3. Close the cap firmly and store the sample in a clean place in the shade.
4. Send the sample to a local authorized laboratory as soon as possible after taking the sample.
5. Write the following data on the sample bottle:
 - Grower's name
 - Location
 - Water source
 - Date sample was taken
6. Request an analysis of all the following parameters:
 - **EC** (electrical conductivity)
 - **pH** (level of acidity or alkalinity)
 - **Ca** (calcium - hardness of the water)
 - **Mg** (magnesium)
 - **Na** (sodium)
 - **K** (potassium)
 - **HCO₃** (bicarbonate)
 - **CO₃** (carbonate)
 - **Alk** (alkalinity)
 - **Cl** (chloride)
 - **SO₄** (sulfate)
 - **PO₄** (phosphate)
 - **N-NH₄** (nitrogen-ammonium)
 - **N-NO₃** (nitrogen-nitrate)
 - **B** (boron)
 - **Fe** (iron)
 - **Mn** (manganese)
 - **TSS** (total suspended solids)
 - **TDS** (total dissolved solids)
 - **Turbidity**
 - **Algae** and **Chlorophyll**
 - **Zooplankton**
 - **BOD** (biochemical oxygen demand*)
 - **COD** (chemical oxygen demand*)
 - **VSS** (volatile suspended solids)

*When waste, industrial effluent and/or recycled waters are used.

All the above parameters are essential for a correct analysis.

In some cases, additional parameters will be needed in order to complete the correct interpretation of the water quality, for example: dissolved oxygen, redox, etc.

If in doubt, consult the Netafim™ laboratory regarding water quality.

7. Taking a sample from the end of a dripperline:
 - Wait until the pressure has stabilized.
 - Open the end of the dripperline and let water flow for 2-3 minutes before taking the sample.
8. Taking a sample from the head control outlet:

To estimate the filtration efficiency, the sample should be taken downstream from the head control outlet, after the system has been working for at least one hour.



NOTE

Take the samples downstream from the pump, but as close to it as possible.

If the field to be irrigated is located more than 1 km away from the pump, take another sample of water at the head of the plot.

In new irrigation projects, water samples should be taken as close as possible to the planned suction point.

DRIP IRRIGATION SYSTEM MAINTENANCE

Sampling drippers

In order to verify the performance of the drippers, sampling of the dripperlines should be performed.

To sample the dripperlines, perform the following steps:

- Cut a 20 cm dripperline sample from the 4th and 5th dripperlines at the beginning and at the end of the dripperline.
- The dripperlines to be sampled are those located in the 4th and 5th places at the beginning and the end of the plot.
- Each sample must be comprised of: the dripper and at least 10 cm of the tube on either side of the dripper.
- Wrap the 16 samples firmly with wet paper and put them in a plastic bag.
- Send the samples to Netafim™ for analysis.
- Repair the dripperlines in the field.
- When the area is composed of several plots, take the samples from one representative plot.

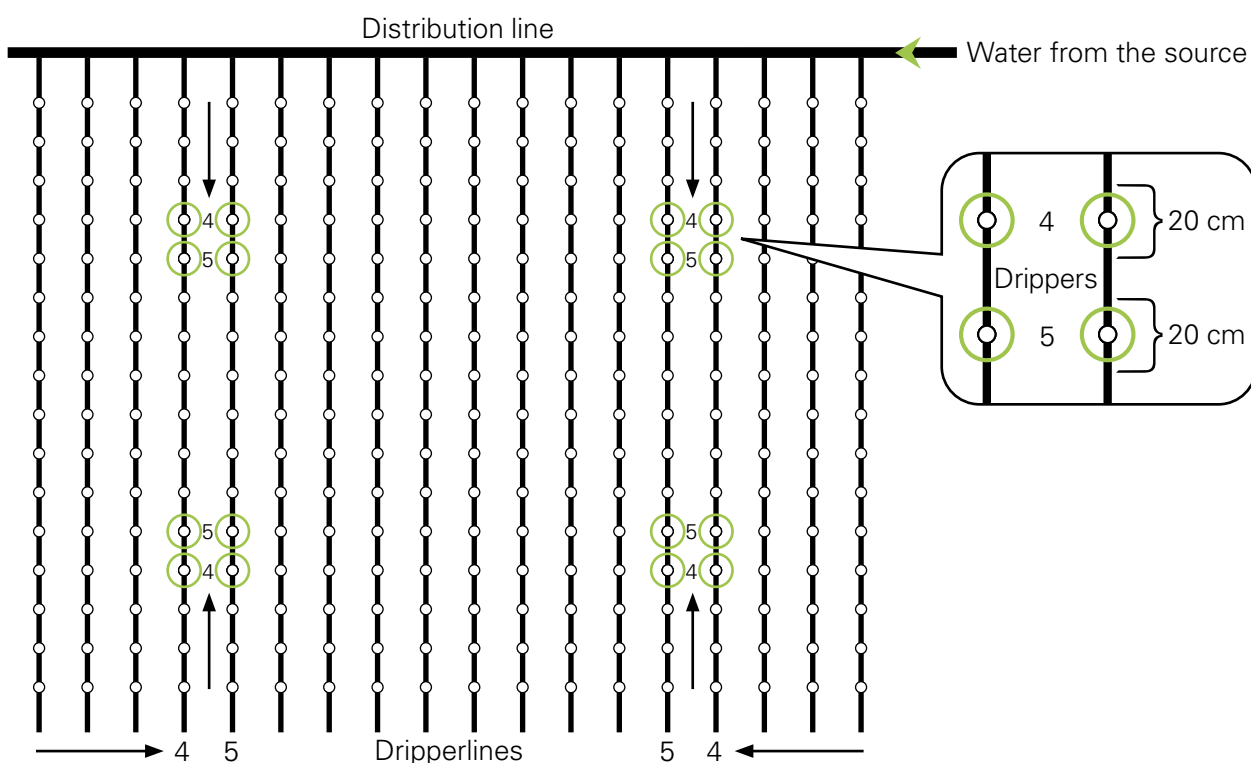

If a different sampling procedure is used, it is very important to describe the process used, and attach this description to the samples.



NOTE

These instructions are suitable both for integral drippers and for online drippers. When taking samples of online drippers, they should be sent together with a dripperline sample of at least 20 cm, in the same way as done for integral drippers.

DRIP IRRIGATION SYSTEM MAINTENANCE

Rodent control

Unmanaged populations of rodents in agricultural fields cause significant damage and loss of productivity in a wide range of crops.

A wide variety of rodents may inhabit agricultural lands, including:

- **Voles**
- **Mice**
- **Rats**
- **Ground squirrels**
- **Gophers**

Small rodents, such as mice and voles, damage young and older trees alike in nurseries and orchards by girdling the tender saplings and branches.

Larger rodents, such as pocket gophers, damage field crops by eating the root system out from under the plant.

Rodents can also damage farm equipment and infrastructure. They may gnaw on small diameter cables and irrigation pipes.

There is no single, simple method for managing rodent overpopulation on agricultural lands. Control of these potential pests requires a well designed plan that is executed on a consistent basis.

Rodent management plan

Management of rodent populations on agricultural land generally falls into the following categories:

- Habitat modification and exclusion to reduce population pressure.
- Trapping and removal.
- Use of repellent to deter invasion.
- Use of repellent to deter gnawing.
- Extermination.

For detailed instructions for the implementation of an effective rodent management plan, see the Rodent Management Guide at <http://www.netafim.com/irrigation-products-technical-materials>.

Preventive installation procedures

The following installation procedures can significantly reduce potential rodent damage to subsurface dripperlines. It is highly recommended that all these procedures be followed:

- If rodent pressures are high, prepare a buffer zone surrounding the field and apply rodenticides according to a plan drawn with the local extension agent.
- Have the field as free of crop residue as possible. Field mice are especially fond of plant residues.
- Insert dripperlines as deep as practical for the crop being grown. Dripperlines inserted at depths greater than 30 cm (12") exhibit less rodent damage.



NOTE

For the germination stage it is not recommended to use dripperlines installed at a depth of 30 cm or more.

- Apply a repellent or toxicant when inserting the dripperline.
- Seal the silt made by the shank using a dedicated tightening roller installed on the insertion machine to reduce ready-made paths for small rodents (see the Agro-Machinery Catalog at <http://www.netafim.com/irrigation-products-technical-materials>).
- Operate the irrigation system for 12 hours per zone within two weeks of completing the installation.

DRIP IRRIGATION SYSTEM MAINTENANCE

Root intrusion prevention in subsurface drip irrigation (SDI) systems

Plant roots can penetrate the drippers, causing a reduction in the flow rate and possibly an obstruction. This is known as root intrusion.

The intrusion of roots may occur when the plant suffers water stress and the roots are searching for moisture.

Maintaining proper humidity in the surroundings by means of adequate irrigation planning allows the roots to spread and use the entire available moistened soil volume, instead of concentrating around the dripper. Continuous soil humidity monitoring allows better control over the moistening pattern, thus maintaining optimal soil humidity within the dripper's surroundings.

Water stress may be:

- Planned at the farmer's discretion.
- Caused by a lack of water or a faulty water supply.
- Due to an unforeseen increase in water consumption by the crop (example: a few consecutive days of unexpected exceptionally high temperatures, without proper irrigation to compensate for the higher water consumption during those days).

Chemigation for the prevention of root intrusion

Injection of herbicides is useful for the prevention of root intrusion. There are a number of commercial products available for this purpose.



CAUTION

Consult the local authority for approved herbicides in the country/area and always follow the application directions.

For detailed instructions for the implementation of effective root intrusion prevention, see the SDI Preventive Maintenance Guide at <http://www.netafim.com/irrigation-products-technical-materials>.

Contamination from external particles in SDI

In rainy periods, when the soil becomes oversaturated due to rain and the subsurface dripperlines are empty, water may flow in the opposite direction, from the soil to the drippers' outlet, bringing soil particles with it. Under these circumstances, the drippers act as draining tubes. The small particles of soil that are carried towards the drippers may, if they are allowed to dry, eventually clog them.

Introducing a short irrigation cycle soon after the rain ends will help flush the small particles from the drippers and prevent clogging.

When there is a very intense and long rainy period, it is recommended to flush the dripperlines prior to the beginning of the next irrigation season.

If these conditions are foreseen, using anti-siphon (AS) drippers is recommended.

In drip irrigation systems not equipped with anti-siphon drippers, activating the system for a period of 10 minutes (after pressurizing) is recommended, in order to flush out the accumulated dirt particles.

For further information, see the SDI Preventive Maintenance Guide at <http://www.netafim.com/irrigation-products-technical-materials>.

DRIP IRRIGATION SYSTEM MAINTENANCE

Periods of system inactivity

Winterization of the system

Winterizing the system is necessary in climates where water may freeze and expand, possibly damaging plastic and metal system components.

Water from filters, valves, chemigation equipment, pressure regulators and subsurface pipelines should be emptied, especially at lower ends of the field where water typically accumulates.

Polyethylene dripperlines are not subject to damage from freezing since drippers provide drainage points and polyethylene is somewhat flexible.

Prior to a winter shut-down period:

Perform chemical injection, flushing of all pipes and dripperlines, and cleaning of the filters.

Empty filters, valves, chemigation equipment, pressure regulators and subsurface pipelines.



TIP

Pressure regulators and subsurface pipelines can be easily and efficiently emptied using a blower or an air compressor providing high flow rate and low pressure.

An adapter is required, consisting of the following parts:

- 3/4" Brauckman pressure regulator
- Galvanized conical connector 3/4"
- 1/2"F - 3/4"M brass coated bushing
- 10 cm galvanized 1/2" pipe
- Stainless steel band clamp
- 3/4" transparent pipe (12m)
- 1/4" F *1/2"M brass coated bushing
- Pressure gauge 250 GLZ 6 bar 1/4" BSP
- 3/4" ball valve with long handle
- Flare connector



For full assembly and operation instructions consult Netafim's irrigation products department.

System startup procedures

Startup procedures after a period of inactivity are similar to those performed after system installation.

In summary, the system should be carefully pressurized and inspected for leaks and system integrity. This includes verifying the functionality of all system components including filters, valves, controllers, chemigation equipment, flow meters, pressure gauges, pressure regulators and flush valves.

Once the system is operational, chemicals should be injected if necessary, and then the system should be thoroughly flushed.

Baseline readings should then be recorded and compared with benchmark data, and adjustments made if needed.

WATER/SOIL/PLANT RELATIONSHIP

Soil	84
Water budgeting	88
Tensiometers	93

WATER / SOIL / PLANT RELATIONSHIP

The aim of this chapter is to provide vital information concerning the soil condition, the water availability and the needs of the crop, and guidelines for planning and management of a drip irrigation system.

Soil

Soil characteristics influence the choice of crop and variety to be grown, and the planning of irrigation and Nutrigation™.

Soil composition

In general, soil is composed of three components: sand, silt and clay. The relative amount of these components affects the soil's texture, influencing its water retention rate.

In most soil types the particles form bigger units, known as aggregates. Aggregates stick together and form clods. Between the particles, aggregates and clods there are pores.

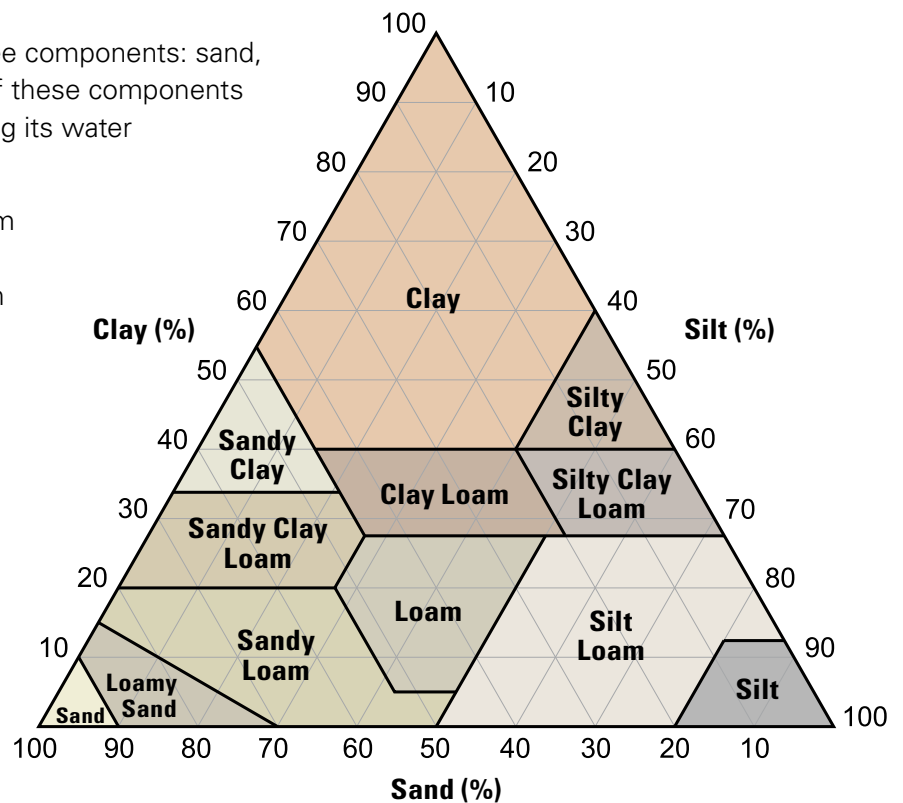

Soil texture

The distribution of pores in the soil is important. Pores are characterized by two sizes: small and big. Small pores are known as "capillary pores". In sandy soil the porosity is permanent and stabilized. In heavy soil the porosity changes depending on changes in the moisture of the soil.

Water retention is affected by the soil texture and type. For example, 15% moisture volume in a light soil will be adequate for crops to flourish, whereas the same percentage in a medium soil would be borderline and in a heavy soil it would not sufficient for plant survival.

The water is trapped in the pores and accumulates as a thin liquid layer around the soil particles. When the soil dries out as a result of percolation, evaporation and root uptake, the water is first extracted from the large pores, while still clinging to the small ones. When the plant needs water, it draws it from the pores starting with the larger ones first.

The mechanism of water retention around soil particles is based on the retention on the surface area of these particles. Sand, silt and clay particles build up and form aggregates, known as the soil structure. Well-structured soils have more pores and retain more water than compact soils.

Silty soils have high water retention rates (they consist of very small particles and display a large surface area). Light soils have low retention rates (they consist of larger particles and display a smaller surface area).

WATER / SOIL / PLANT RELATIONSHIP

Soil texture affects irrigation scheduling in two important ways:

- It determines how quickly the soil accepts water, and it should be known prior to design of a drip irrigation system since it influences dripper flow rate and spacing.
- It determines how much water the root zone water reservoir holds, and how much of that water is available to the plant.

Soil water content

The relationship between water/soil/plant is important to understand. The following three states have an enormous impact on the crop.

Saturation

Occurs when all pores in the soil are filled with water.

Field capacity

Occurs when the maximum amount of water that the field can hold is reached. As percolation proceeds, the soil reaches the point where it does not lose any more water. This is the optimal condition for crop development, as the water is held at a force that is easily overcome by the uptake power of the roots, and at the same time the soil is sufficiently ventilated to enable the roots to breathe.

Wilting point

The state of the water in the soil that defines the point at which the plant no longer has the ability to absorb water from the soil. Beyond the wilting point, the plant cannot survive and crop wilting is irreversible.

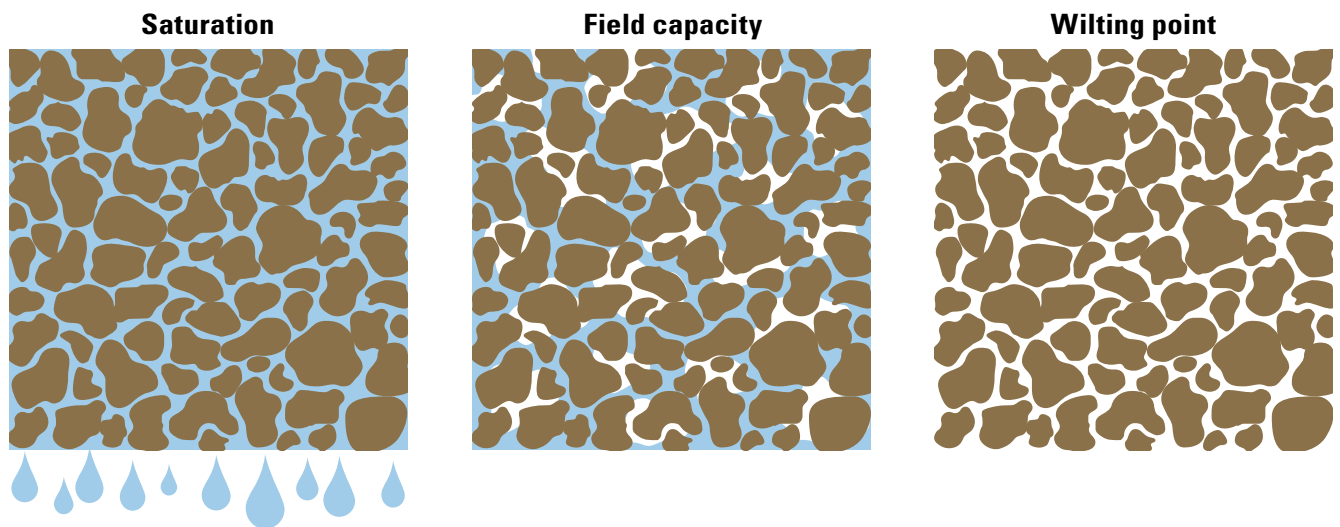

Water availability

Water availability is the difference between field capacity and the wilting point. Field capacity is defined as the state at which the field has reached the point at which the maximum amount of water can be held. The wilting point is defined as the state at which the field contains the minimum amount of water required for a plant to survive.

Saturated soil*	100 g	40 ml	
Field capacity	100 g	20 ml	Air
Wilting coefficient	100 g	10 ml	Air
Hygroscopic coefficient	100 g	8 ml	Air
	Solid		Pore space

*In a saturated field, much of the water is lost to gravity and cannot be used for plant growth.

■ Solid ■ Water

WATER / SOIL / PLANT RELATIONSHIP

Soil salinity

The higher the concentration of salts in the soil solution, the greater the electrical current that can be passed through it. Therefore, the electrical conductivity (EC) of the saturation extract is used as an indicator of soil salinity.

Rates of soil classification in terms of salinity and levels considered critical to assess tolerance of cultures to excess salts are based on the electrical conductivity of the saturation extract (ECe) at 25°C (77°F).

In the past, the unit used to measure the EC was mmhos/cm (milimohs per centimeter), but today the unit used is dS/m (deciSiemens per meter).

$$1\text{dS/m} = 1\text{mmhos/c} = 1\text{mS/cm} = 100\text{mS/m.}$$

High soil salinity is typical of low rainfall level.

The decrease in crop yield varies with the level of soil salinity

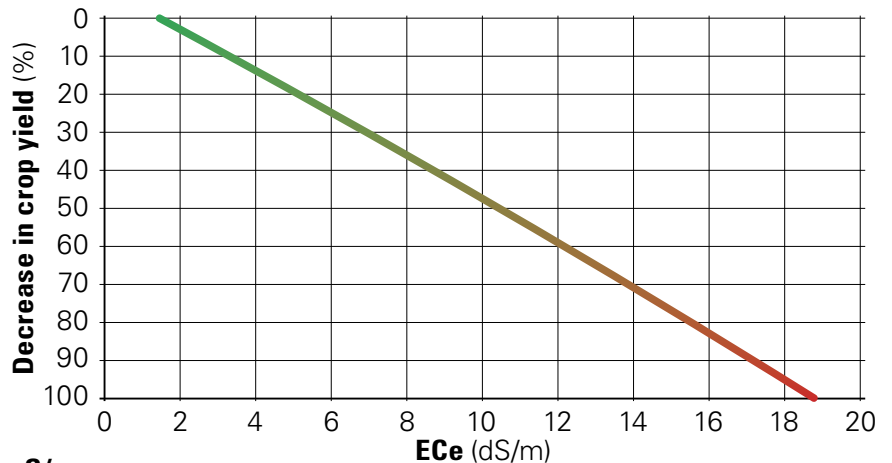

Soil pH

The soil pH is a measure of the acidity or basicity (alkalinity) in soils. pH is defined as the negative logarithm (base 10) of the activity of hydronium ions (H⁺ or, more precisely, H₃O⁺) in a solution.

In water, it normally ranges from 1 to 14, with 7 being neutral. A pH below 7 is acidic and above 7 is basic.

Soil pH is considered a master variable in soils as it controls many chemical processes that take place. It specifically affects plant nutrient availability by controlling the chemical forms of the nutrient. The optimum pH range for most plants is between 5.5 and 7.0; however many plants have adapted and thrive at pH values outside this range.

The influence of soil pH on nutrient availability*

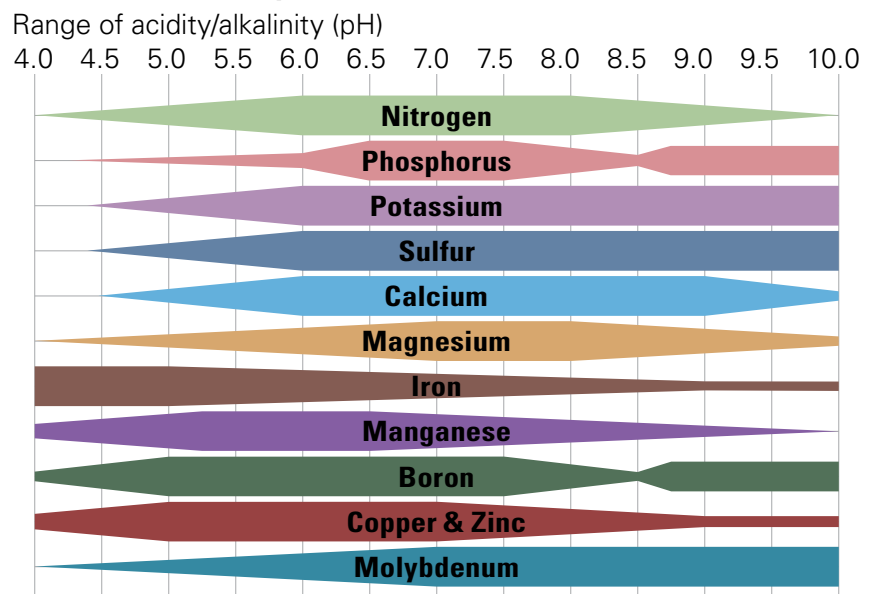

*Not applicable for soilless.

Soil requirement

A well drained, deep, loamy soil having adequate aeration (10 to 12%) with a ground water table below 1.5 to 2.0 m from soil surface, a bulk density of 1.4 g/cm³ and an available water holding capacity of 15% (15 cm of water per meter depth of soil) or more is considered optimal.

- Chemical constraints in the soils, such as acidity and low fertility, are relatively easy to correct or control by means of the precise nutrients and acid injection option offered by the drip irrigation system.

WATER / SOIL / PLANT RELATIONSHIP

- Although poor physical properties of soil are more difficult to ameliorate, and are widely accepted as a limiting factor in crop growth, drip irrigation is able to counter them by means of precise control of irrigation quantification, frequency and scheduling.

Soil analysis

A soil analysis is necessary in order to prescribe an appropriate irrigation and Nutrigation™ plan, to determine the dripperline characteristics (dripper spacing and flow rate) and the proper spacing of the dripperlines in the field.

Required tools:

- 2 (two) 10 liters (2.5 gallons) buckets
- A hoe/shovel
- A soil drill

Taking a soil sample:

- Walking along the field's diagonal, take soil samples every 50-100 meters, depending on the field's size.
- 2 samples are to be taken at each sampling point:
 - at a depth of 0-30 cm (0-1 foot) and at a depth of 30-60 cm (1-2 feet).
- Put all the shallow-taken samples in one bucket and all the deep-taken samples in the other.
- Thoroughly mix the content of each bucket.
- Take 1.5 kg (3 pounds) of the mixture from each bucket, and put these in sealed plastic bags.
- Mark the 2 bags with the necessary identifying data and the depth of sampling.
- Mark the required parameters to be analyzed in the accompanying document.
- Send the samples to a laboratory certified by the local relevant authority.

The mandatory parameters to analyze:

- Soil mechanical composition
- EC and pH
- NPK
- Ca
- Mg

Many other parameters can be analyzed at the grower's request (consult an agronomist).

Soil survey

In new projects a soil survey is also necessary. It is important for the understanding of the soil's water holding capacity and of water percolation in the soil.

The soil survey consists of:

- Digging pits with a backhoe in selected locations in the field, depending on the field's size and the varying characteristics of the soil.
- The pits should be dug so that they expose the soil cross-section, revealing the various soil layers, generally to a depth of 2 meters (7 feet) depending on the crop to be grown.
- 3 soil samples are taken from each pit - shallow, middle and deep. Each sample is packed separately and identified.
- The samples are sent to a certified laboratory for analysis.

For full details consult a Netafim™ expert.

WATER / SOIL / PLANT RELATIONSHIP

Water budgeting

Calculate the daily water ration to be returned to the crop by tracking daily additions and losses of water and balancing them. The losses are due to crop water use and leach (percolation) requirements. The additions are due to irrigation and rainfall.

The objective of water budgeting is to maintain soil moisture near the optimum level by keeping track of crop water use and then irrigating to replace the water used. Knowledge of crop water use is essential to water budgeting (see [Calculating the Daily Water Requirement](#), page 51).

Crop water use is also called the evapotranspiration rate (EVT). The term evapotranspiration refers to the combined loss of water through evaporation from the soil and from water taken up and evaporated from the plants (transpiration). The rate at which plants use water is determined by the growth stage of the plant and the weather. Plants generally use more water the hotter or dryer the conditions are. Wind and clouds also affect the evaporation rate.

The water budgeting method for irrigation is relatively straightforward, but must be adjusted for crop growth stage and environmental conditions such as rain.

To effectively plan irrigation, growers need to account for crop water use measured as evapotranspiration (EVTc). Daily crop water requirements (EVTc) are calculated by multiplying the reference crop evapotranspiration (EVT_o) at each stage of development by the crop coefficient (K_c).

The reference evapotranspiration rate (EVT_o) can be calculated from weather data or measured as evaporation from a calibrated pan of water. Both methods give a close approximation of the environmentally induced evaporation rate from a given area of soil. Real pan evaporators are still used in many parts of the globe. However, in recent years the EVT_o is increasingly estimated based on weather data, which includes temperature, relative humidity, wind velocity and solar radiation using the Penman-Monteith equation, which relates these variables to evaporation rate.

Actual crop water usage is usually not exactly the same as the reference evapotranspiration rate (EVT_o). First, plants regulate the quantity of water they require by closing or opening stomata (small pores in their leaves used to maintain appropriate water levels in the plant). The difference between the actual peak crop water use and the pan evaporation rate is referred to as the crop coefficient (K_c). The EVT of the crop expressed as EVTc can be calculated from the EVT_o using the following formula.

$$\text{EVTc} = \text{EVT}_o * K_c$$

Calculation of the required irrigation time according to reference evapotranspiration:

EXAMPLE

The crop coefficient (K_c) is 0.8. If the EVT_o, either measured by means of an evaporation pan or calculated with the Penman-Monteith equation, is 7.5 mm/day, then the crop will be using:

$$\text{EVTc} = 7.5 * 0.8 = 6 \text{ mm/day}$$

WATER / SOIL / PLANT RELATIONSHIP

EXAMPLE

Daily water usage of 4 crops per crop development stage over a growing season

Corn (Maize)

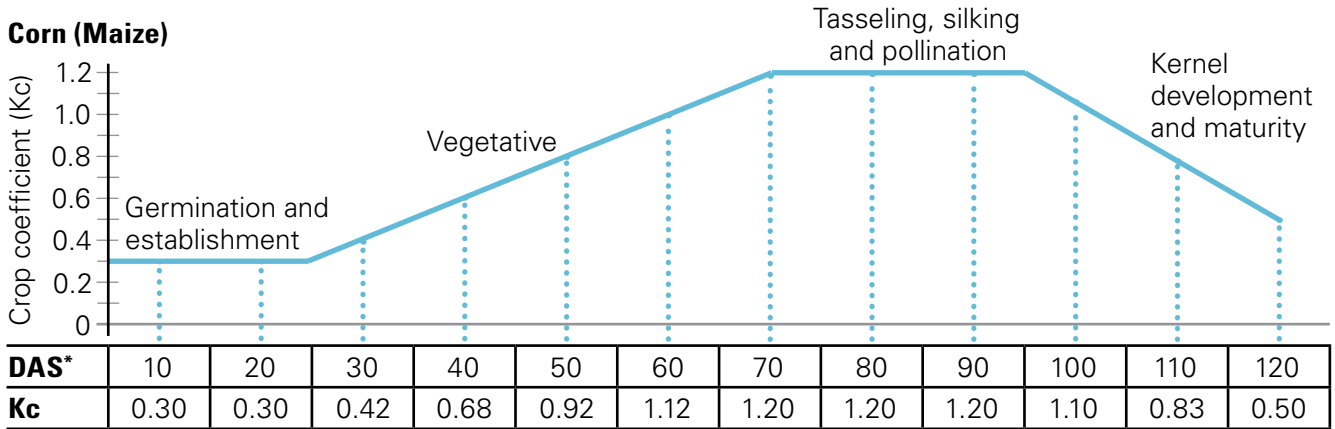

Soya

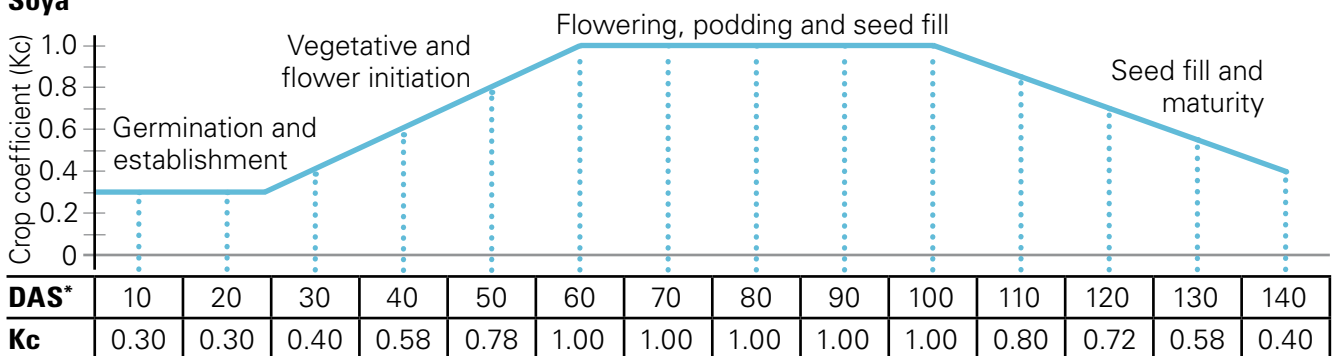

Processing tomato

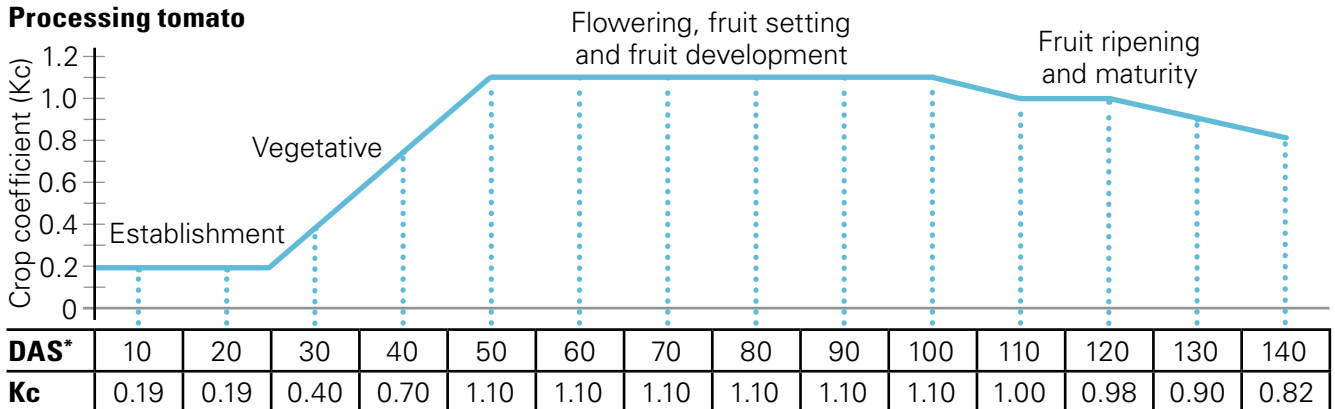

Apple (with fruits)

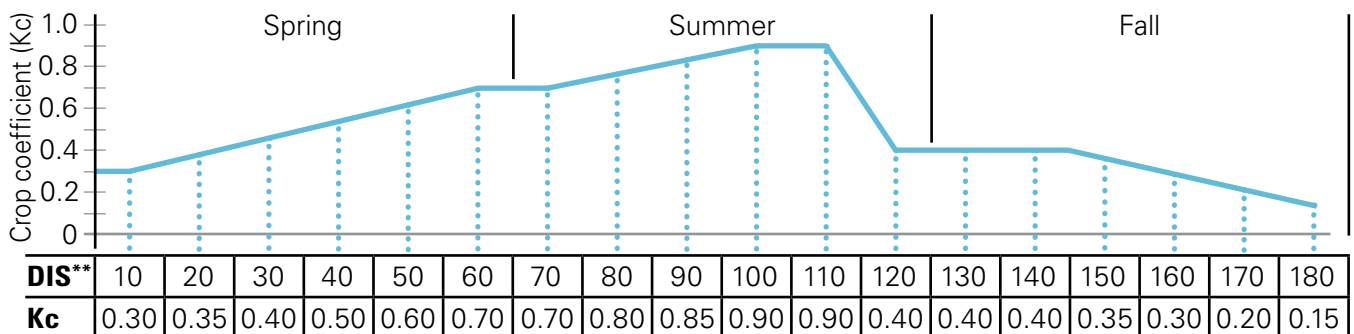

*DAS = Days After Seeding **DIS = Days Into Season

WATER / SOIL / PLANT RELATIONSHIP

Evaporation pan

An evaporation pan is used to hold water for observations aimed at determining the quantity of evaporation at a given location. Such pans are of varying sizes and shapes, the most commonly used being circular. The best known of the pans is the "Class A" evaporation pan. Often the evaporation pans are automated with water level sensors and a small weather station is located nearby.



A cylinder with a diameter of 47.5 in (120.7 cm) and a depth of 10 in (25 cm). The pan rests on a carefully leveled, wooden base and is often enclosed by a chain link fence to prevent animals drinking from it.

Evaporation is measured daily at the same time as the depth of water evaporated from the pan. The measurement day begins with the pan filled to exactly 2 in (5 cm) from the pan top. 24 hours later, the amount of water needed to refill the pan to exactly 5 cm (2 in) from its top is measured.

If precipitation occurs in the 24-hour period, it is taken into account in calculating the daily evaporation.

If the precipitation that occurred is greater than the pan capacity, the excess water should be emptied and the level of water in the pan should be reset to enable measurement in the next 24 hours.

The Class A Evaporation Pan is not usable on days with rainfall events of more than the pan capacity. Evaporation cannot be measured in a Class A pan when the pan's water surface is frozen.

The Penman-Monteith equation

The Penman-Monteith equation (after Howard Penman and John Monteith) predicts net evapotranspiration (EVT), requiring as input: daily mean temperature, wind speed, relative humidity and solar radiation.

The Penman-Monteith equation is increasingly common as evaporation evaluation method nowadays, also due to the use of meteorological stations in agricultural projects.

The United Nations Food and Agriculture Organization (FAO) standard methods for modeling evapotranspiration use the Penman-Monteith equation.

Glossary

Crop coefficient (Kc): The ratio of evapotranspiration (EVT) to reference evapotranspiration (EVT_o) for a given crop when growing in large fields under optimum growing conditions.

Pan coefficient (kp): The ratio of reference evapotranspiration (EVT_o) to pan evaporation (E_o) for the same period.

Pan evaporation (E_o): The depth of water that evaporates from an evaporation pan during a certain period in mm/day or mm/month.

WATER / SOIL / PLANT RELATIONSHIP

The relation between pan evaporation and calculated evaporation

It is important to understand that there are differences in the values obtained by the two methods of evaporation evaluation, and thus the crop coefficient (Kc) will vary according to the method used for evaporation evaluation.

However, assuming the quantity of water needed by the plant on any day is the same, it is necessary to find a ratio between the two methods in order to calculate correct quantities of water.

Namely, if the evaporation is established by the Penman–Monteith calculation method, the Irrigation Crop coefficient (Kc) should be in accordance with the evaporation calculation method (Penman–Monteith).

The crop coefficient (Kc) obtained with the Class A pan evaporation method is different from the Kc obtained when using the Penman-Monteith calculation method.



EXAMPLE

In order to determine the new coefficients, data of the two methods were continuously gathered from 18 meteorological stations during 5 to 10 years (2000-2009).

Generally, the evaporation values obtained with the Penman-Monteith method are lower than the values derived with the Class A pan evaporation method, but the data behavior differs from one region to another.

Ratio of evaporation value - Class A pan evaporation / Penman-Monteith calculated evaporation (1/x) in the same area throughout the year:

Ratio of evaporation value

Class A pan evaporation/Penman-Monteith calculated evaporation (1/x) in the same area throughout the year:

The values of the evaporation ratios of the two methods must be calculated for each area separately. It is not advisable to use values taken in different areas because the values differ from one area to another and change during the year in the same area.

Location	June	July	August
A	0.60	0.58	0.59
B	0.77	0.76	0.76
C	0.89	0.90	0.89

Calculation:

- Class A pan evaporation = EVTo pan Class A
- Evaporation according to Penman-Monteith = Kc A

If the quantity of water the crop requires is the same, the following ratio is obtained:

$$\text{EVTo pan Class A} * \text{Kc A} = \text{EVTo Penman-Monteith} * \text{Kc Penman-Monteith}$$

Consequently, the following ratio may be inscribed:

$$\frac{\text{EVTo PnMo}}{\text{EVTo A}} = \frac{\text{Kc A}}{\text{KcPnMo}}$$

And according to the table above, the ratio EVToPM / EVTo A is always lower than one (1).

The following table shows that if the irrigation coefficient according to Class A pan evaporation (Kc A) and the calculated evaporation (EVTo Penman-Monteith) are available, it is possible to use the ratio between calculated evapotranspiration and pan evapotranspiration (EVTo PM / EVTo A) to calculate the value of the crop coefficient (Kc) according to Penman-Monteith and to calculate the quantity of irrigation water.

WATER / SOIL / PLANT RELATIONSHIP

EXAMPLE

Finding the crop coefficient (Kc) according to Penman-Monteith and the quantity of irrigation water (mm/day) where the values for pan evaporation coefficient (Kc A), calculated evapotranspiration (EVTo Penman-Monteith) and evapotranspiration ratio are given.

Attribute	Description	Value		
		June	July	August
Pan evapotranspiration coefficient	Kc A	0.25	0.25	0.30
Calculated evapotranspiration	EVTo Penman-Monteith (mm/day)	6.0	6.0	5.4
Evapotranspiration ratio	EVTo Penman-Monteith / EVTo Pan Class A	0.65	0.69	0.68
Penman-Monteith evapotranspiration coefficient	$Kc \text{ Penman-Monteith} = Kc A / (\text{EVTo Penman-Monteith} / \text{EVTo Pan Class A})$	0.385	0.362	0.441
Total irrigation water (mm/day)	$X \text{ mm/day} = \text{EVTo Penman-Monteith} \times Kc \text{ Penman-Monteith}$	2.31	2.17	2.38

The above is just an example. There is not only one Kc value for each crop in each area, many factors can influence this value, the specific Kc value should be based on data from a local meteorological station.

Summary

If evaporation data are used for the calculation of the irrigation water consumption of a specific crop, on a particular day or over a certain period of time, the data-obtaining method has to be known, and the appropriate crop coefficient (Kc) to be used is to be selected accordingly.

If ratio values between Class A pan evaporation (Kc A) and calculated evapotranspiration (EVTo Penman-Monteith) are to be calculated, local or zonal values must be used.

Tensiometers

When buried in the soil, the ceramic tip of the tensiometer allows water to move freely in or out of the tube. As the soil dries, water is sucked out through the porous ceramic tip, creating a partial vacuum inside the tensiometer which is read on the vacuum gauge. When the soil is wetted by sufficient rainfall or irrigation, water flows back into the tensiometer, the vacuum decreases and the gauge reading is lowered.



NOTE

Tensiometers do not operate in dry soil because the pores in the ceramic tip drain and air is sucked in through them, breaking the vacuum seal between the soil and the gauge on top of the tensiometer.

What do the tensiometer readings mean?

Vacuum gauges are normally calibrated in kilopascals (from 0 to -100 kPa).

Tensiometers operate successfully up to approximately -75 kPa.

A reading of 0 kPa indicates saturated soil in which plants will suffer from lack of oxygen.

Optimum plant growth occurs when the soil is kept wetter than:

- -15 to -25 kPa for coarse textured soils (sands).
- -20 to -30 kPa for medium-textured and heavy-textured soils.

Readings in excess of -70 kPa indicate that the soil is dry enough to reduce growth.

In most situations two sites will be needed for each major species or variety and soil type in the field or the orchard. Avoid high or low sites, zones of poor water infiltration, and sites not representing the entirety of the field or the orchard.



CAUTION

All tensiometers must be marked clearly to avoid damage from traffic, workers and cultivation.

Irrigation timing with tensiometers

Tensiometers placed at about the mid-point of the main fibrous root system are used to determine when to irrigate. This is particularly important during the period when the water requirement of the tree (or crop) is highest and yields are most sensitive to water shortage. During this period tensiometers should be read daily. Tensiometer readings indicate how hard the plant/tree is working to extract moisture. Following irrigation the tensiometer's reading will be lower. Daily readings should continue to determine when irrigation is required again.

For [tensiometer description](#) see page 39.

APPENDIX 1

Unit conversion tables

DISTANCE	
1 kilometer (km) = 0.621 mile (mi)	1 mile (mi) = 1.609 kilometers (km) = 1609.344 meters (m)
1 meter (m) = 3.281 feet (ft)	1 foot (ft) = 0.305 meter (m)
1 meter (m) = 39.370 inches (in)	1 inch (in) = 0.025 meter (m)
1 centimeter (cm) = 0.394 inch (in)	1 inch (in) = 2.54 centimeters (cm)

AREA	
1 hectare (ha) = 2.471 acres (ac)	1 acre (ac) = 0.4047 hectare (ha)
1 hectare (ha) = 10,000 square meters (m ²)	1 square meter (m ²) = 0.0001 hectare (ha)
1 acre (ac) = 4,047 square meters (m ²)	1 square meter (m ²) = 0.00025 acre (ac)
1 hectare (ha) = 0.004 square mile (mi ²)	1 square mile (mi ²) = 259 hectares (ha)
1 hectare (ha) = 15 mu	1 mu = 0.0666 hectare (ha)
1 square kilometer (km ²) = 0.386 square mile (mi ²)	1 square mile (mi ²) = 2.59 square kilometers (km ²)
1 square centimeter (cm ²) = 0.155 square inch (in ²)	1 square inch (in ²) = 6.452 square centimeters (cm ²)
1 square foot (ft ²) = 0.155 square inch (in ²)	1 square meter (m ²) = 10.76 square foot (ft ²)

FLOW	
1 cubic meter per hour (m ³ /h) = 264.1721 gallons (USG) per hour (gph)	1 gallon (USG) per hour (gph) = 0.0038 cubic meter per hour (m ³ /h)
1 liter per hour (l/h) = 0.2641721 gallon (USG) per hour (gph)	1 gallon (USG) per hour (gph) = 3.785 liters per hour (l/h)

PRESSURE	
1 bar = 14.50377 pounds per square inch (psi)	1 pound per square inch (psi) = 0.06894757 bar
1 bar = 100 kilopascals (kPa)	1 kilopascal (kPa) = 0.01 bar
1 PSI = 6.894757 kilopascals (kPa)	1 kilopascal (kPa) = 0.145 pound per square inch (psi)

VOLUME	
1 gallon (USG) = 3.785 liters (L)	1 liter (L) = 0.264 gallon (USG)

WEIGHT	
1 kilogram (kg) = 2.205 pounds (lb)	1 pound (lb) = 0.454 kilogram (kg)

TEMPERATURE	
°Celsius	°Fahrenheit
0	= 32
5	= 41
10	= 50
15	= 59
20	= 68
25	= 77
30	= 86
35	= 95

POWER	
1 kilowatt (kW)	= 1.341022 horse power (HP)
1 kilowatt (kW)	= 56.91965 British thermal units per minute (BTU/min)
1 horse power (HP)	= 0.7456999 kilowatt (kW)

FILTRATION*							
Micron (µm) = size of gaps between fibers	400	250	177	125	105	100	74
Mesh = number of pores per linear inch	40	60	80	120	140	150	200

*The mesh to micron conversion is not a proper mathematical conversion but a commercial approximation.

APPENDIX 2

Further reading

This appendix provides the reader with links to recommended complementary documents discussing drip irrigation-related subjects at length.

Download them at <http://www.netafim.com/irrigation-products-technical-materials>

Guidelines for Irrigation Systems Maintenance

The implementation of a simple yet strict maintenance program for drip irrigation systems will keep the system operating at peak performance and increase the system's work life expectancy.

This manual will guide you in determining the correct procedure and its implementation. The best way to determine if your maintenance program is effective is to constantly monitor and record the flow rate and pressures in the system.

Subsurface Drip Irrigation (SDI)

SDI is an irrigation management tool that enables consistently high yields, better water and fertilizer management and reduced fertilizer and water usage.

This guide describes the specifications, design, installation, operation, and maintenance of an SDI system. It is intended as an aid in the selection of subsurface drip irrigation and the management of the system to obtain the desired results.

Dripperlines, drippers & other emitters - Product catalog

This catalog is an aid to enable to find basic data on each of the drip products within a hand's reach.

The catalog describes the main applications of the item displayed, its features and benefits, technical data of drippers and dripperlines, a table of all active catalog numbers and basic packaging data.

Fittings & Accessories - Product Catalog

Netafim™ Accessories & Fittings Components product families are designed to complement and support efficient and professional utilization of dip irrigation systems.

Netafim™ Accessories & Fittings Components are an integral part of the irrigation system. Each component is manufactured under the strictest quality control standards ensuring maximum system performance and reliability.

The catalog presents Netafim's wide variety of Manifolds; Dripperlines accessories; Holders; Clips; Adaptors and Plugs; Stakes & Spikes; Pressure Regulators; Product Assemblies; Tools.

Agro-Machinery - Product Catalog

Netafim™ offers a wide variety of application tools and auxiliaries designed for simple, rapid and efficient installation and removal of dripperlines avoiding damage to the drippers and maintaining their integrity.

The catalog presents Netafim's line of insertion, extraction, laying and retrieval machinery and accessories.

Connectors - Product Catalog

Netafim™ comprehensive range of pipe connector systems is made of high resistance and durability polymers. Use the catalog to select the right line for your application: barb connectors, fast ring connectors, Flare connectors, Twist Lock connectors and a vast family of start and reducing connectors.

Polyethylene Rigid and Flexible Pipes - Product Catalog

For use in agricultural irrigation systems, water delivery systems, sprinkler and micro-sprinkler stands, assembly dripper sets and automation application.

The catalog presents Netafim's range of standard irrigation pipes, tubes and Micro-tubes 3*5, 4*6.5, 6*8 and 9*12 and Micro-tubes 8mm.

GROW MORE WITH LESS

WWW.NETAFIM.COM