

FRONT VIEW

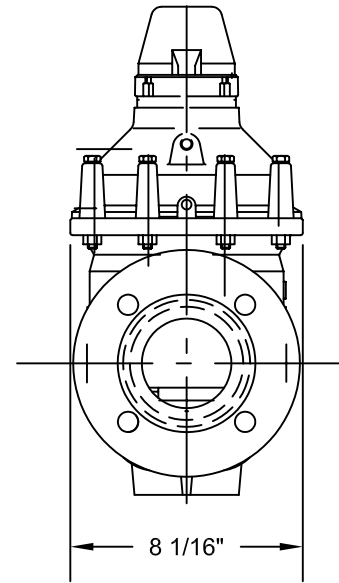

SIDE VIEW

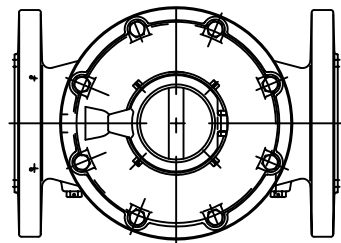

PLANE OR TOP VIEW

00

HYDROMETER 3" FLG

NOT TO SCALE



DETAIL - PH30